

DESCRIPTION

The EV2235S-J-00A demonstrates MPS's MP2235S, a high-frequency, synchronous, rectified, step-down converter with built-in high-side and low-side power MOSFETs. The MP2235S offers a very compact solution to achieve a 3A continuous output current with excellent load and line regulation over a wide input supply range. The MP2235S has synchronous mode operation for higher efficiency over the output current load range.

Current-mode operation provides fast transient response and eases loop stabilization.

Full protection features include over-current protection (OCP) and thermal shut down (TSD).

The MP2235S is available in a space saving 8-pin TSOT23 package.

ELECTRICAL SPECIFICATION⁽¹⁾

Parameter	Symbol	Value	Units
Input Voltage	V _{IN}	12	V
Output Voltage	V _{OUT}	3.3	V
Output Current	I _{OUT}	3	A
Frequency	F _{SW}	800	kHz

Notes:

1) For different input /output voltage, inductor value, output-capacitor value, and switching frequency may affect the selection of application circuit parameters.

FEATURES

- 120mΩ/50mΩ Low R_{DS(ON)} Internal Power MOSFET
- High-Efficiency Synchronous Mode Operation
- Fixed 800kHz Switching Frequency
- Synchronizes from a 300kHz-to-2MHz External Clock
- Power-Save Mode at Light Load
- External Soft-Start
- Over Current Protection and Hiccup
- Thermal Shutdown
- Output Adjustable from 0.804V
- Available in a 8-pin TSOT-23 Package

APPLICATIONS

- Notebook System and I/O Power
- Digital Set-Top Boxes
- Flat-Panel Television and Monitors
- Distributed Power Systems

All MPS parts are lead-free, halogen free, and adhere to the RoHS directive. For MPS green status, please visit MPS website under Quality Assurance.

"MPS" and "The Future of Analog IC Technology" are Registered Trademarks of Monolithic Power Systems, Inc. ADAM (Analog Digital Adaptive Modulation) and AAM (Advanced Asynchronous Mode) are trademarks of Monolithic Power Systems, Inc.

EV2235S-J-00A EVALUATION BOARD



Board Number	MPS IC Number
EV2235S-J-00A	MP2235SGJ

Efficiency vs. Load Current

V_{OUT}=3.3V, L=3.3μH

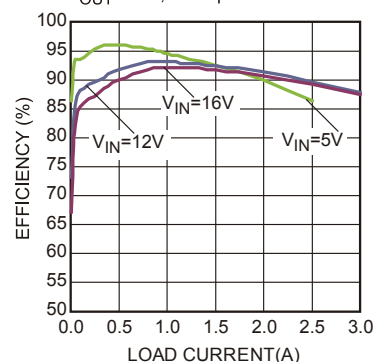

EVALUATION BOARD SCHEMATIC

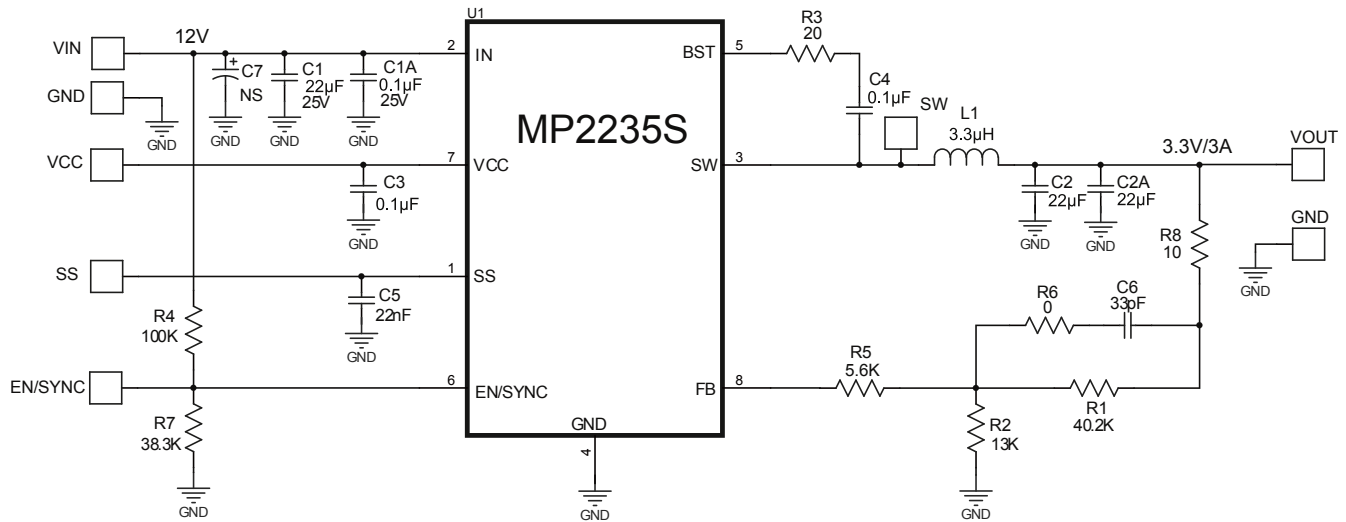

EV2235S-J-00A BILL OF MATERIALS

Qty	Ref	Value	Description	Package	Manufacturer	Manufacturer P/N
1	C1	22µF	Ceramic Cap., 25V, X5R	1206	muRata	GRM31CR61E226KE15L
1	C1A	0.1µF	Ceramic Cap., 25V, X7R	0603	muRata	GRM188R71E104KA01D
2	C2, C2A	22µF	Ceramic Cap., 10V, X7R	1206	muRata	GRM31CR70A226KE19L
2	C3,C4	0.1µF	Ceramic Cap., 16V, X7R	0603	muRata	GRM188R71C104KA01D
1	C5	22nF	Ceramic Cap., 50V, X7R	0603	muRata	GRM188R71H223KA01D
1	C6	33pF	Ceramic Cap,50V,C0G	0603	muRata	GRM1885C1H330JA01D
0	C7	NS				
1	R1	40.2K	Thick Film Res., 1%	0603	Yageo	RC0603FR-0740K2L
1	R2	13K	Thick Film Res., 1%	0603	Yageo	RC0603FR-0713KL
1	R3	20Ω	Thick Film Res., 1%	0603	Yageo	RC0603FR-0720RL
1	R4	100K	Thick Film Res., 1%	0603	Yageo	RC0603FR-07100KL
1	R5	5.6K	Thick Film Res., 1%	0603	Yageo	RC0603FR-075K6L
1	R6	0Ω	Thick Film Res., 1%	0603	Yageo	RC0603FR-070RL
1	R7	38.3K	Thick Film Res., 1%	0603	Yageo	RC0603FR-0738K3L
1	R8	10Ω	Thick Film Res., 1%	0603	Yageo	RC0603FR-0710RL
1	L1	3.3µH	Inductor, DCR=17.2mΩ, Is=11A	SMD	Wurth	744311330
1	U1	MP2235SGJ	Synchronous Step-Down Converter	TSOT23-8	MPS	MP2235SGJ

EVB TEST RESULTS

Performance waveforms are tested on the evaluation board.

$V_{IN} = 12V$, $V_{OUT} = 3.3V$, $L = 3.3\mu H$, $T_A = 25^\circ C$, unless otherwise noted.

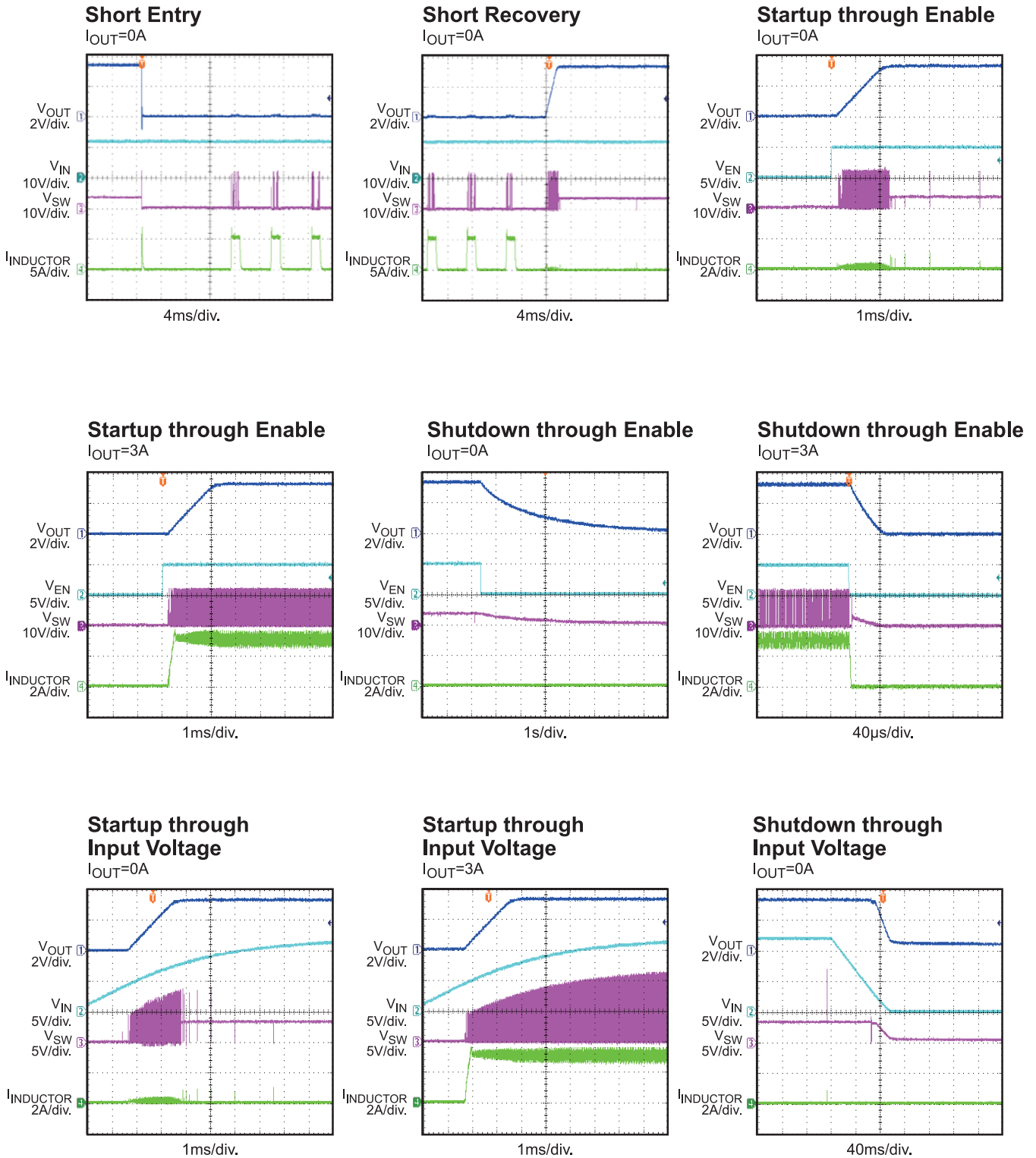

EVB TEST RESULTS (continued)

Performance waveforms are tested on the evaluation board.

$V_{IN} = 12V$, $V_{OUT} = 3.3V$, $L = 3.3\mu H$, $T_A = 25^\circ C$, unless otherwise noted.

Shutdown through Input Voltage

$I_{OUT} = 3A$

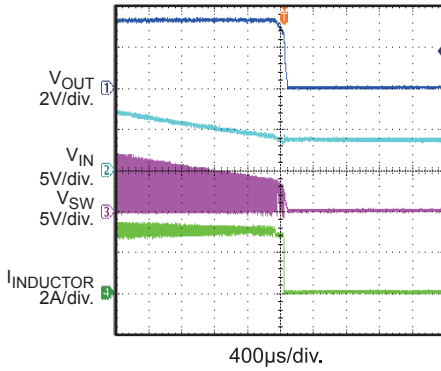

Input / Output Ripple

$I_{OUT} = 3A$

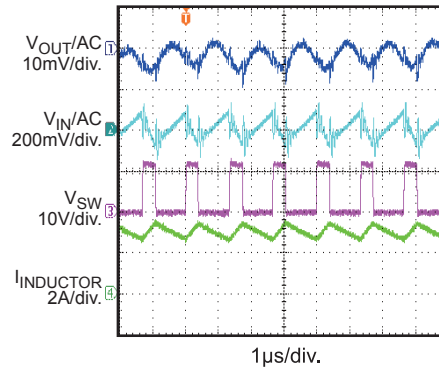

Load Transient Reponse

$I_{OUT} = 1.5A$ to $3A$

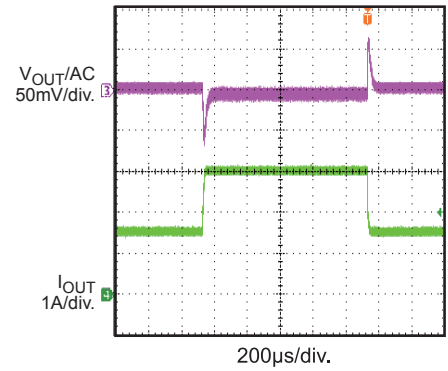

PRINTED CIRCUIT BOARD LAYOUT

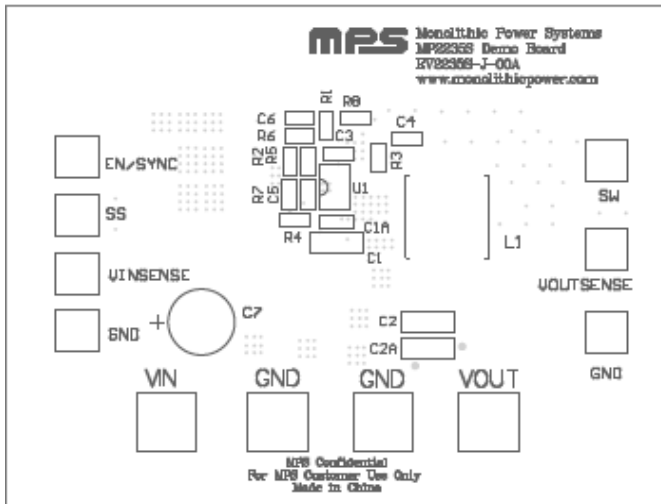

Figure 1—Top Silk Layer

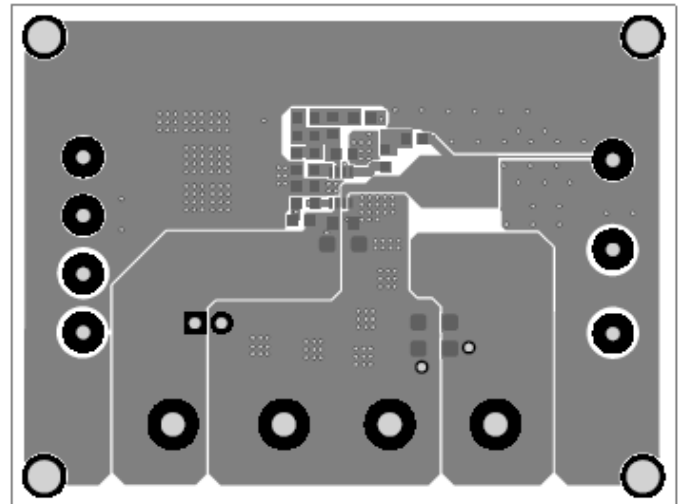

Figure 2—Top Layer

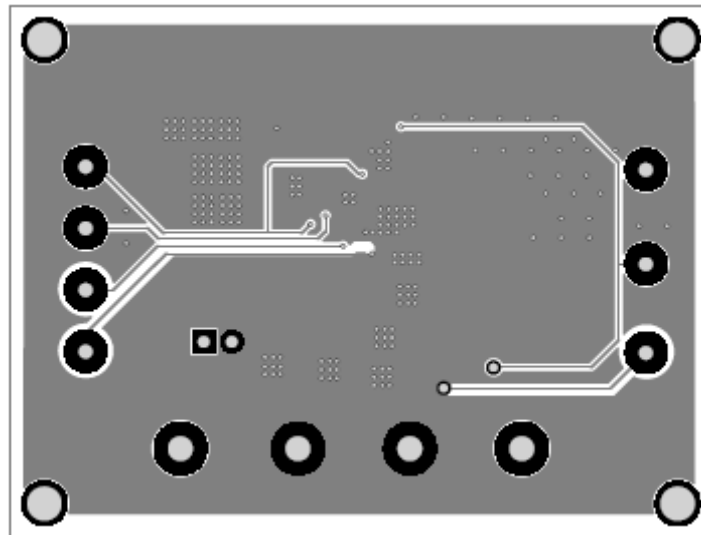

Figure 3—Bottom Layer

QUICK START GUIDE

1. Connect the positive and negative terminals of the load to the VOUT and GND pins, respectively.
2. Preset the power supply output 12V, and then turn off the power supply.
3. Connect the positive and negative terminals of the power supply output to the VIN and GND pins, respectively.
4. Turn the power supply on. The board will automatically start up.
5. To use the Enable function, apply a digital input to the EN pin. Drive EN higher than 1.4V to turn on the regulator or less than 1.25V to turn it off.

NOTICE: The information in this document is subject to change without notice. Please contact MPS for current specifications. Users should warrant and guarantee that third party Intellectual Property rights are not infringed upon when integrating MPS products into any application. MPS will not assume any legal responsibility for any said applications.