

DESCRIPTION

The EV2229-Q-00A is the evaluation board for MP2229, a high-frequency synchronous rectified step-down switch mode converter with internal power MOSFETs. It offers a very compact solution to achieve 6A continuous output current over a wide input supply range with excellent load and line regulation. The MP2229 has synchronous mode operation for higher efficiency over the output current load range.

Current mode operation provides fast transient response and eases loop stabilization. Full protection features include over-current protection and thermal shutdown.

The MP2229 requires a minimal number of readily-available standard external components and is available in a space saving 3mm x 3mm 14-pin QFN package.

ELECTRICAL SPECIFICATIONS

Parameter	Symbol	Value	Units
Input Voltage	V_{IN}	4.5-21	V
Output Voltage	V_{OUT}	1	V
Output Current	I_{OUT}	6	A

FEATURES

- Wide 4.5V to 21V Operating Input Range
- 6A Output Current
- Low $40m\Omega/18m\Omega$ $R_{DS(ON)}$ of Internal Power MOSFETs
- Programmable Switching Frequency
- Frequency SYNC from 300kHz to 2MHz External Clock
- Low Power Mode Selectable by External Signal
- External Soft Start
- Pre-Bias Startup
- OCP with Hiccup Mode
- Thermal Shutdown
- Output Adjustable from 0.6V
- Available in QFN-14 (3mmx3mm) Package

APPLICATIONS

- DSL Modems
- Cable Modems
- Set -Top Boxes
- Telecom
- Distributed Power Systems

All MPS parts are lead-free, halogen free, and adhere to the RoHS directive. For MPS green status, please visit MPS website under Quality Assurance. "MPS" and "The Future of Analog IC Technology" are Registered Trademarks of Monolithic Power Systems, Inc.

EV2229-Q-00A EVALUATION BOARD



Board Number	MPS IC Number
EV2229-Q-00A	MP2229GQ

Efficiency vs. Load Current

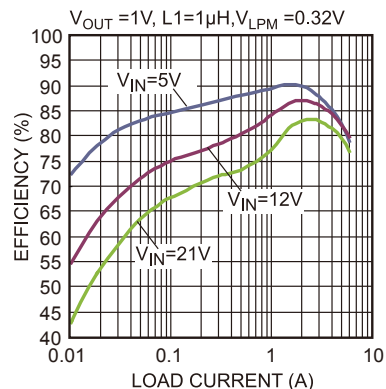

EVALUATION BOARD SCHEMATIC

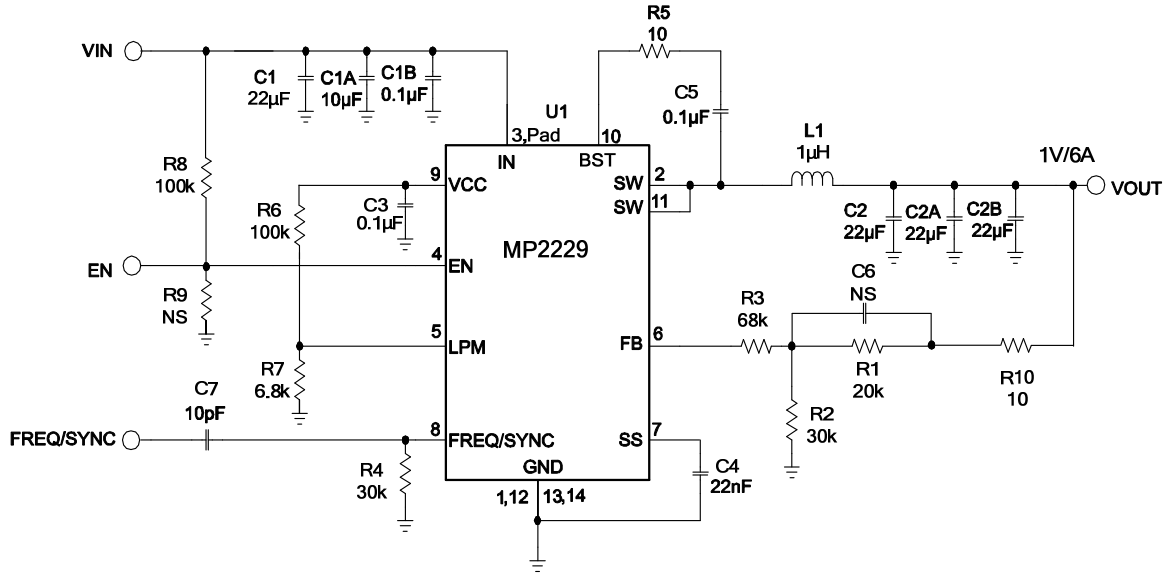

EV2229-Q-00A BILL OF MATERIALS

Qty	Ref	Value	Description	Package	Manufacturer	Part Number
1	C1	22μF	Ceramic Cap., 25V, X5R	1206	Murata	GRM31CR61E226KE15L
1	C1A	10μF	Ceramic Cap., 25V, X5R	1206	Murata	GRM31CR61E106KA12L
1	C1B	0.1μF	Ceramic Cap., 25V, X7R	0603	Murata	GRM188R71E104KA01D
3	C2,C2A C2B	22μF	Ceramic Cap., 10V, X7R	1206	Murata	GRM31CR71A226KE15L
2	C3,C5	0.1μF	Ceramic Cap., 16V, X7R	0603	Murata	GRM188R71C104KA01D
1	C4	22nF	Ceramic Cap., 50V, X7R	0603	Murata	GRM188R71H223KA01D
0	C6	NS		0603		
1	C7	10pF	Ceramic Cap., 50V, C0G	0603	Murata	GRM1885C1H100JA01D
1	R1	20kΩ	Film Res., 1%	0603	YAGEO	RC0603FR-0720KL
2	R2,R4	30kΩ	Film Res., 1%	0603	YAGEO	RC0603FR-0730KL
1	R3	68kΩ	Film Res., 1%	0603	YAGEO	RC0603FR-0768KL
2	R5, R10	10Ω	Film Res., 1%	0603	YAGEO	RC0603FR-0710RL
2	R6, R8	100KΩ	Film Res., 1%	0603	YAGEO	RC0603FR-07100KL
1	R7	6.8KΩ	Film Res., 1%	0603	YAGEO	RC0603FR-076K8L
0	R9	NS		0603		
1	L1	1μH	DCR=4.6mΩ, Is=19A	SMD	Würth	744311100
1	U1	MP2229	Step-Down Converter	QFN14-3x3mm	MPS	MP2229GQ

EVB TEST RESULTS

Performance waveforms are tested on the evaluation board.

$V_{IN} = 12V$, $V_{OUT} = 1V$, $L = 1\mu H$, $F_s = 500kHz$, $T_A = 25^\circ C$, unless otherwise noted.

Input/Output Ripple

$I_{OUT} = 0A$

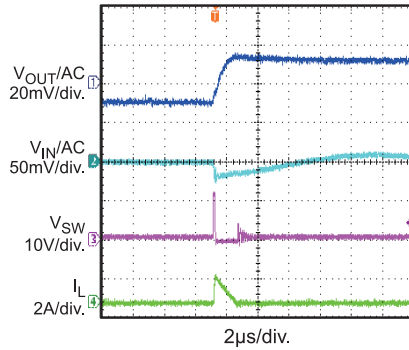

Input/Output Ripple

$I_{OUT} = 6A$

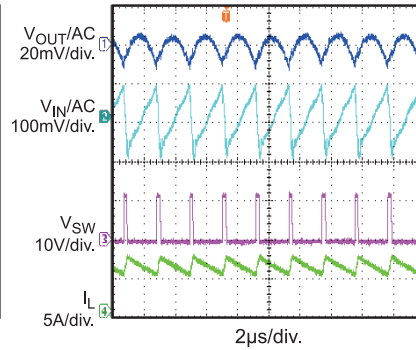

Startup Through Input Voltage

$I_{OUT} = 0A$

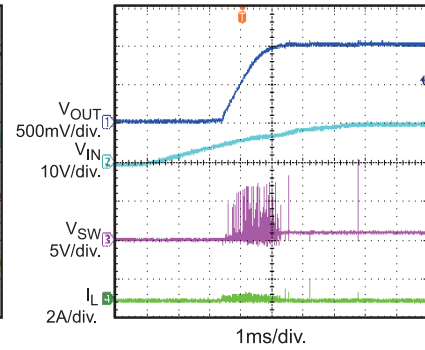

Startup Through Input Voltage

$I_{OUT} = 6A$

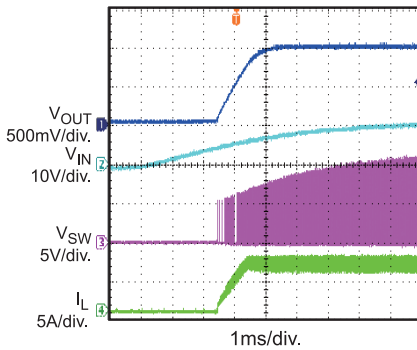

Shutdown Through Input Voltage

$I_{OUT} = 0A$

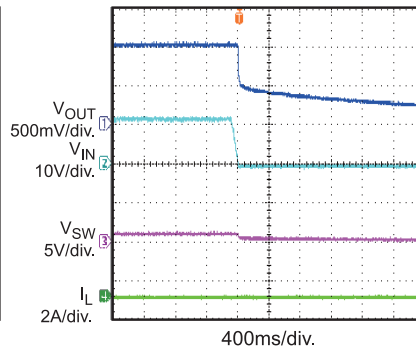

Shutdown Through Input Voltage

$I_{OUT} = 6A$

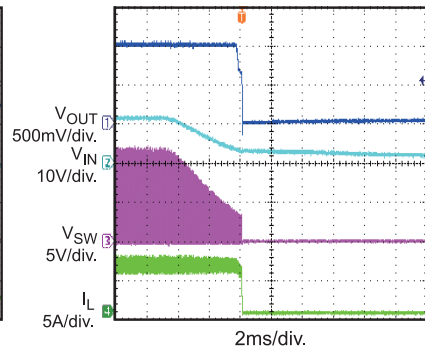

Startup Through Enable

$I_{OUT} = 0A$

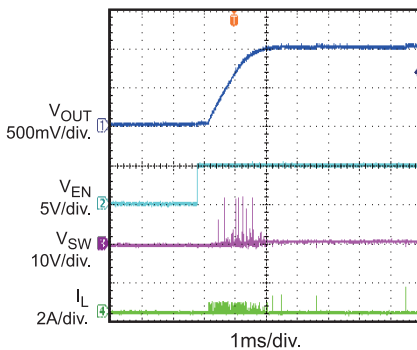

Startup Through Enable

$I_{OUT} = 6A$

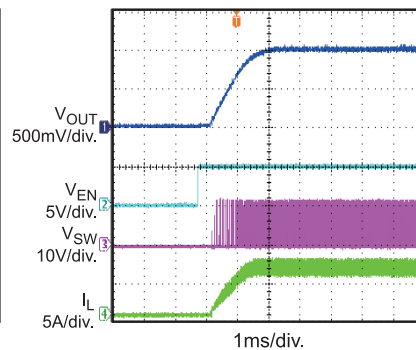

Shutdown Through Enable

$I_{OUT} = 0A$

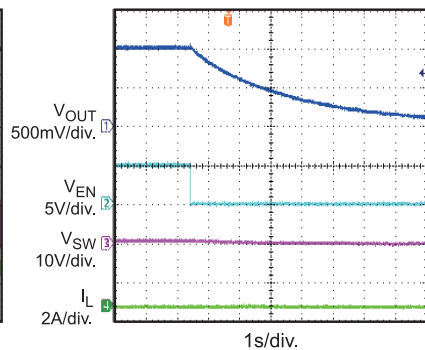

EVB TEST RESULTS *(continued)*

Performance waveforms are tested on the evaluation board.

$V_{IN} = 12V$, $V_{OUT} = 1V$, $L = 1\mu H$, $F_s = 500kHz$, $T_A = 25^\circ C$, unless otherwise noted.

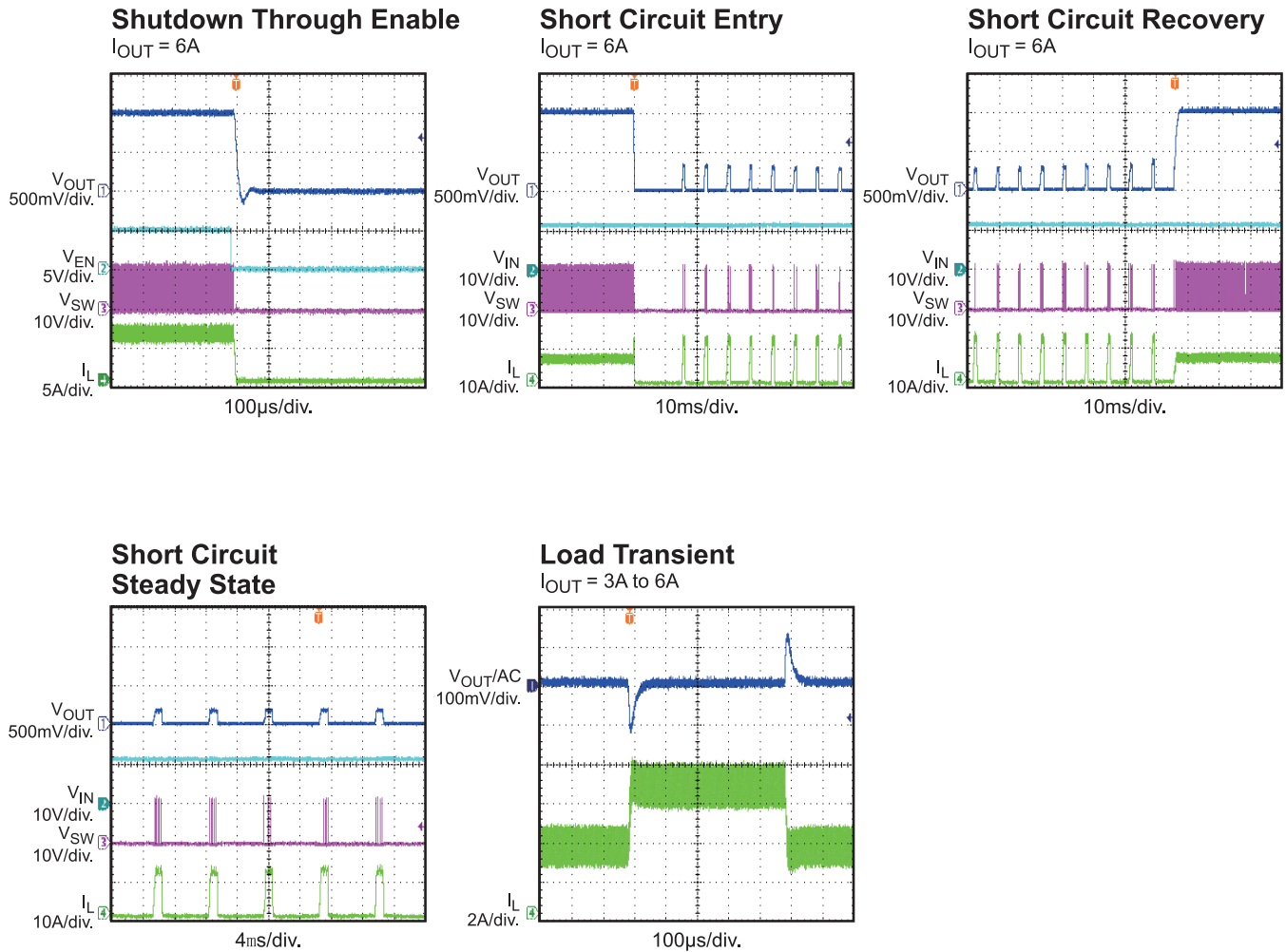

PRINTED CIRCUIT BOARD LAYOUT

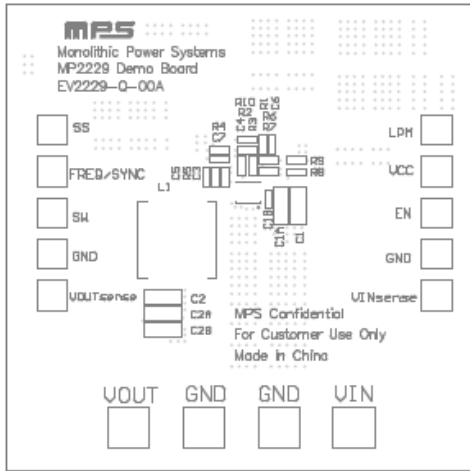

Figure 1—Top Silk Layer

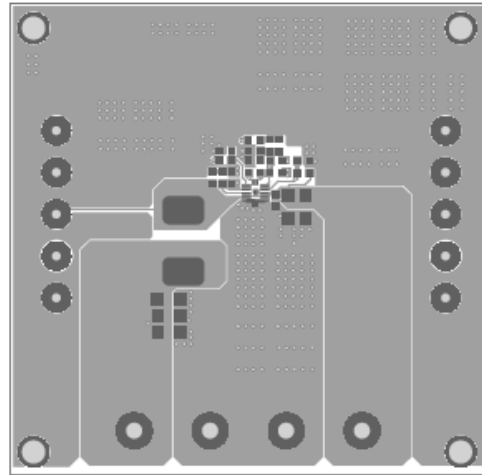

Figure 2—Top Layer

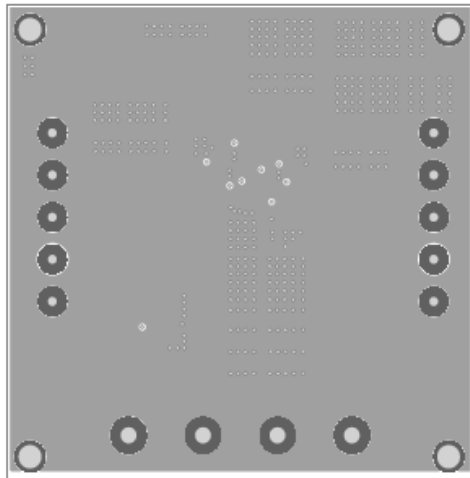

Figure 3—Inner1 Layer

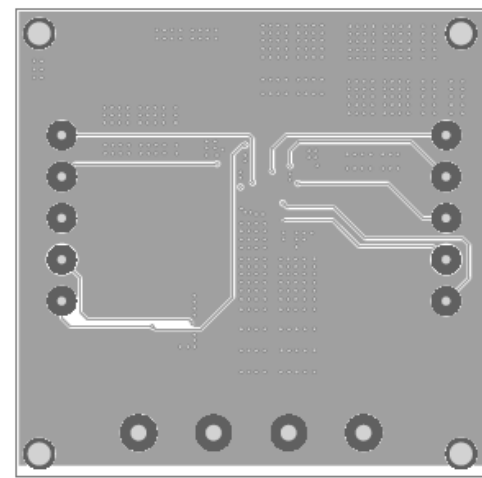

Figure 4—Inner2 Layer

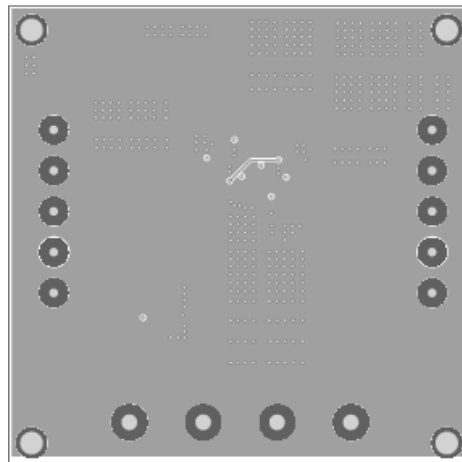

Figure 5— Bottom Layer

QUICK START GUIDE

1. Connect the positive terminal of the load to VOUT pin, and the negative terminal of the load to GND pin.
2. Preset the power supply output to 4.5V-21V and turn off the power supply.
3. Connect the positive terminal of the power supply output to the VIN pin and the negative terminal of the power supply output to the GND pin.
4. Turn the power supply on. The MP2229 will automatically startup.
5. To use the Enable function, apply a digital input to EN pin. Drive EN higher than 1.7V to turn on the regulator, drive EN less than 0.9V to turn it off.
6. To use the external synchronous function to adjust the switching frequency, apply an external clock signal to FREQ/SYNC pin through 10pF AC coupling capacitor.

NOTICE: The information in this document is subject to change without notice. Users should warrant and guarantee that third party Intellectual Property rights are not infringed upon when integrating MPS products into any application. MPS will not assume any legal responsibility for any said applications.