



EV2174C-G-00A

4A, 5.5V, 1.1MHz Synchronous Step-Down Switcher Evaluation Board

DESCRIPTION

The EV2174C-G-00A is used for demonstrating the performance of MPS's MP2174C, a low voltage high switching frequency step-down switcher with built in power MOSFETs. MP2174C provides up to 4A highly efficient output with constant-on-time control for fast loop response. The output voltage can be regulated as low as 0.6V.

High power efficiency over a wide load range is achieved by scaling down the switching frequency at light load to reduce the switching related loss by constant on time control. Short circuit and thermal shutdown provides reliable, fault-tolerant operation.

MP2174C is available in QFN12 (2x2mm) package.

ELECTRICAL SPECIFICATION

Parameter	Symbol	Value	Units
Input Voltage	V_{IN}	2.7– 5.5	V
Output Voltage	V_{OUT}	1.2	V
Output Current	I_{OUT}	4	A

FEATURES

- Forced PWM Mode Operation
- Wide 2.7V to 5.5V Operating Input Range
- Output Voltage as Low as 0.6V
- 4A Output Current
- 35m Ω and 18m Ω Internal Power MOSFET
- 1.1MHz Frequency
- 100% Duty cycle in Dropout
- 0.5ms Internal Soft-Start Time
- EN and Power Good for Power Sequencing
- Auto Discharge at Power-off
- Short Circuit Protection with Hiccup Mode
- Available in a QFN12 (2x2mm) Package

APPLICATIONS

- Storage Drives
- Portable/Handheld Devices
- PDAs
- DVD Drives
- Wireless/Networking Cards
- Low Voltage I/O System Power

All MPS parts are lead-free and adhere to the RoHS directive. For MPS green status, please visit MPS website under Quality Assurance. "MPS" and "The Future of Analog IC Technology" are Registered Trademarks of Monolithic Power Systems, Inc.

EV2174C-G-00A EVALUATION BOARD

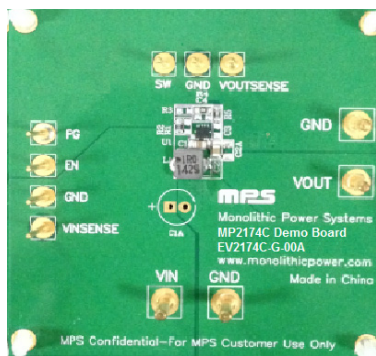

Board Number	MPS IC Number
EV2174C-G-00A	MP2174CGG

Efficiency vs. Output Current

$V_{IN}=5V$, $DCR=27m\Omega$

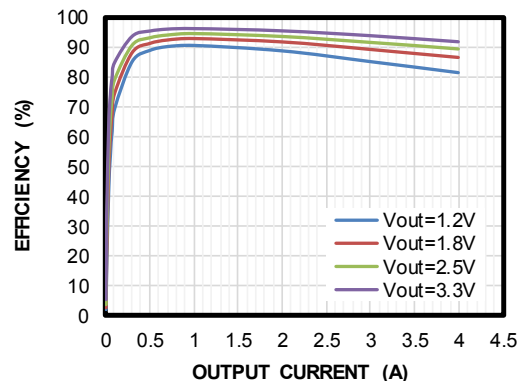

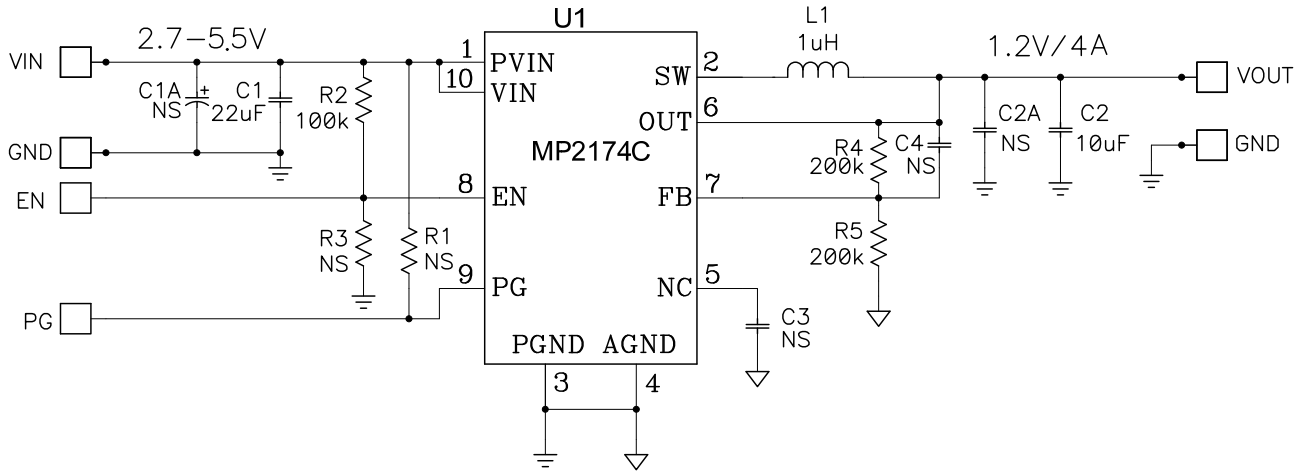
EVALUATION BOARD SCHEMATIC

EV2174C-G-00A BILL OF MATERIALS

Qty	RefDes	Value	Description	Package	Manufacturer	Manufacturer P/N
	C1A,C2A, C3,C4	NS				
1	C1	22µF	Ceramic Cap., 10V, 20%, X5R	0805	Taiyo Yuden	LMK212BJ226MG-T
1	C2	10µF	Ceramic Cap., 6.3V, 10%, X5R	0805	muRata	GRM21BR70J106KE76L
1	L1	1.0µH	Inductor, I _S = 9A, DCR=27mΩ	SMD	Würth	74437324010
	R1	NS				
1	R2	100k	Film Res., 5%	0603	Yageo	RC0603JR-07100KL
	R3	NS				
2	R4,R5	200k	Film Res., 5%	0603	Yageo	RC0603JR-07200KL
1	U1	MP2174C	Synchronous Step-Down switcher	QFN12- 2x2mm	MPS	MP2174CGG

TYPICAL PERFORMANCE CHARACTERISTICS

$V_{IN} = 5V$, $V_{OUT} = 1.2V$, $L = 1\mu H$, $T_A = +25^\circ C$, unless otherwise noted.

Output Ripple

$V_{IN}=3.6V$, $V_{OUT}=3.3V$, $I_{OUT}=0A$

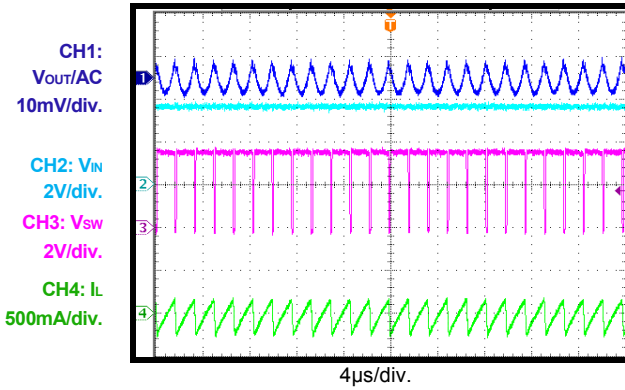

Output Ripple

$V_{IN}=5V$, $V_{OUT}=1.2V$, $I_{OUT}=0A$

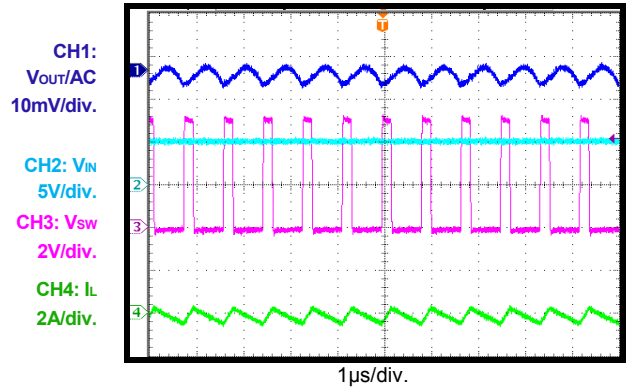

Output Ripple

$V_{IN}=5V$, $V_{OUT}=1.2V$, $I_{OUT}=4A$

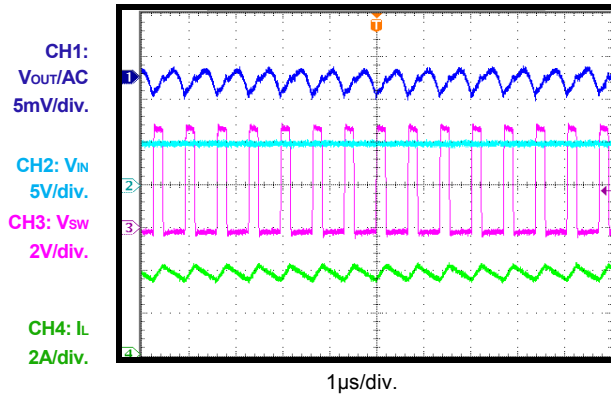

Transient

$I_{OUT}=2A$ to $4A$, $2.5A/\mu s$

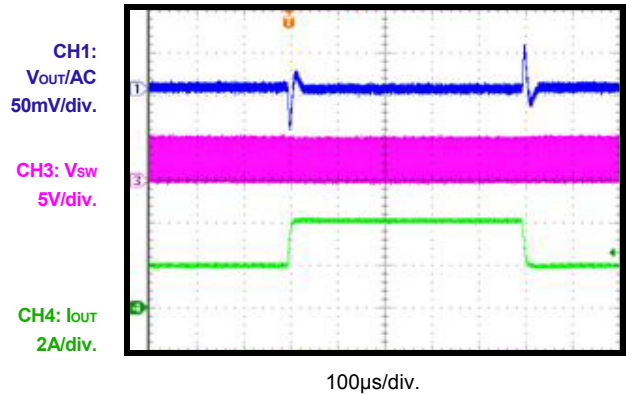

VIN Start-Up

$I_{OUT}=0A$

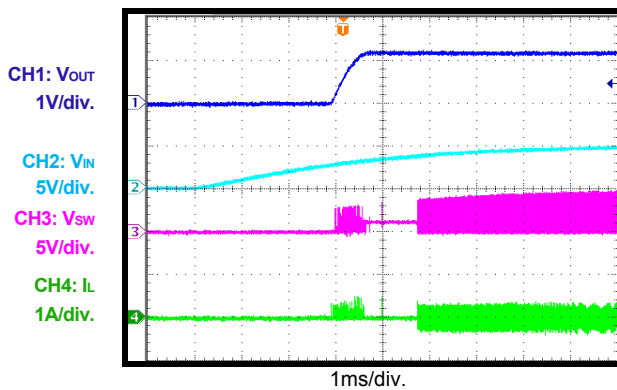

VIN Start-Up

$I_{OUT}=4A$

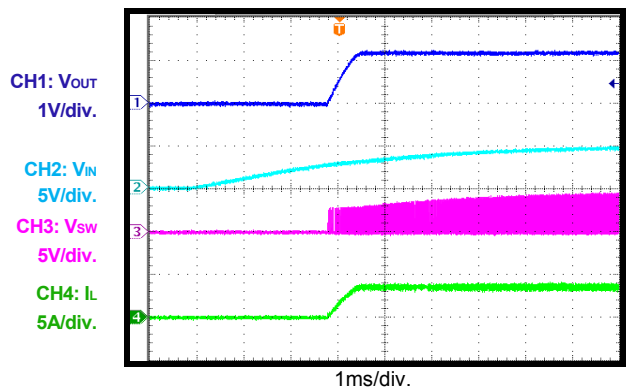

TYPICAL PERFORMANCE CHARACTERISTICS *(continued)*

$V_{IN} = 5V$, $V_{OUT} = 1.2V$, $L = 1\mu H$, $T_A = +25^\circ C$, unless otherwise noted.

VIN Shutdown

$I_{OUT} = 0A$

CH1: V_{OUT}
1V/div.
CH2: V_{IN}
5V/div.
CH3: V_{SW}
5V/div.
CH4: I_L
1A/div.

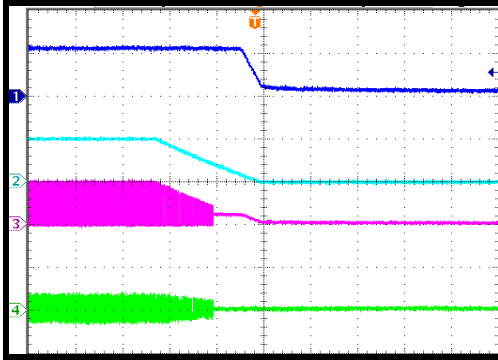

VIN Shutdown

$I_{OUT} = 4A$

CH1: V_{OUT}
1V/div.
CH2: V_{IN}
5V/div.
CH3: V_{SW}
5V/div.
CH4: I_L
5A/div.

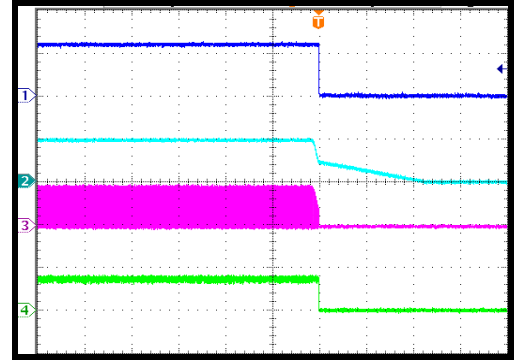

EN Start-Up

$I_{OUT} = 0A$

CH1: V_{OUT}
1V/div.
CH2: V_{EN}
5V/div.
CH3: V_{SW}
5V/div.
CH4: I_L
1A/div.

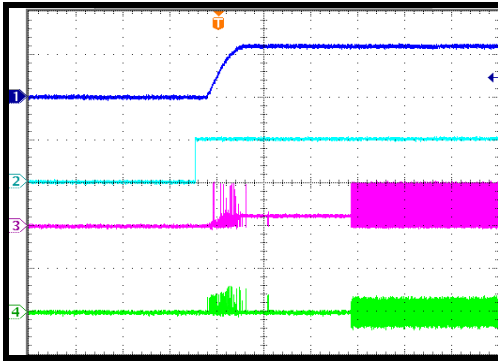

EN Start-Up

$I_{OUT} = 4A$

CH1: V_{OUT}
1V/div.
CH2: V_{EN}
5V/div.
CH3: V_{SW}
5V/div.
CH4: I_L
5A/div.

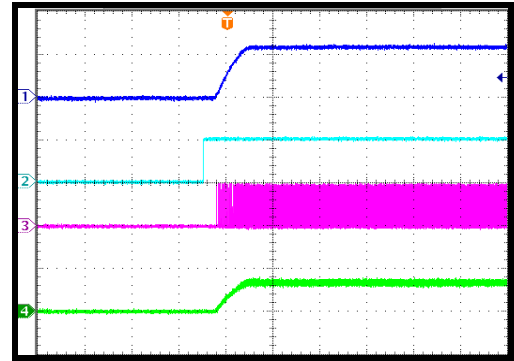

EN Shutdown

$I_{OUT} = 0A$

CH1: V_{OUT}
1V/div.
CH2: V_{EN}
5V/div.
CH3: V_{SW}
5V/div.
CH4: I_L
1A/div.

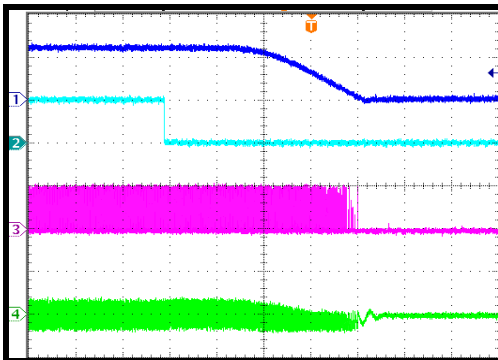

EN Shutdown

$I_{OUT} = 4A$

CH1: V_{OUT}
1V/div.
CH2: V_{EN}
5V/div.
CH3: V_{SW}
5V/div.
CH4: I_L
5A/div.

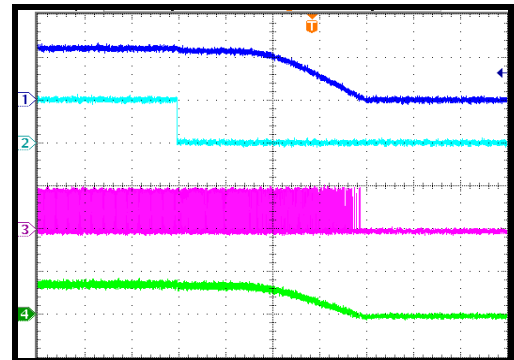

TYPICAL PERFORMANCE CHARACTERISTICS *(continued)*

$V_{IN} = 5V$, $V_{OUT} = 1.2V$, $L = 1\mu H$, $T_A = +25^\circ C$, unless otherwise noted.

SCP Entry

$I_{OUT} = 4A$

CH1: V_{OUT}
1V/div.
CH2: V_{IN}
5V/div.
CH3: V_{sw}
5V/div.
CH4: I_L
5A/div.

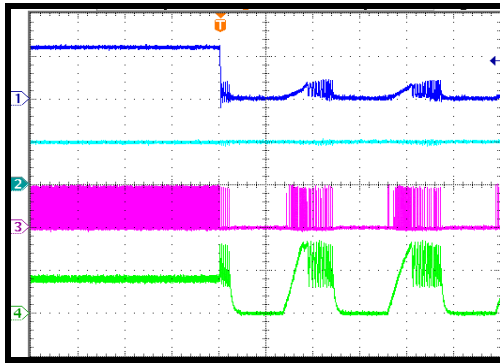

SCP Recovery

$I_{OUT} = 4A$

CH1: V_{OUT}
1V/div.
CH2: V_{IN}
5V/div.
CH3: V_{sw}
5V/div.
CH4: I_L
5A/div.

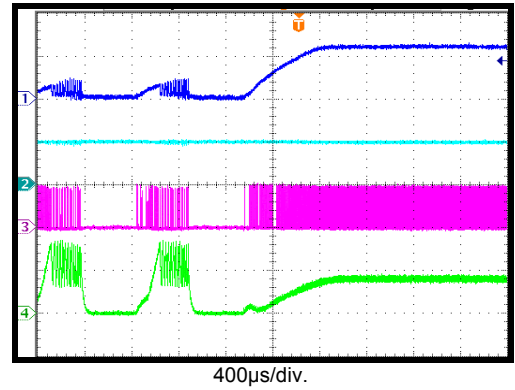

SCP State

$I_{OUT} = 4A$

CH1: V_{OUT}
1V/div.
CH2: V_{IN}
5V/div.
CH3: V_{sw}
5V/div.
CH4: I_L
5A/div.

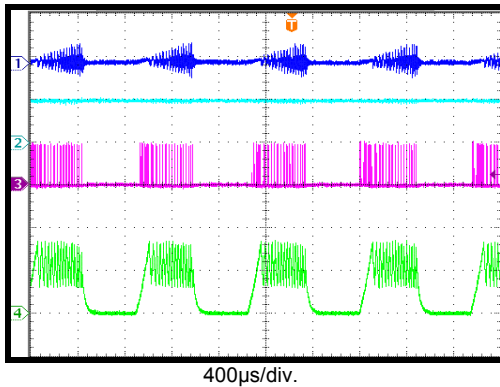

SCP Entry

$I_{OUT} = 0A$

CH1: V_{OUT}
1V/div.
CH2: V_{IN}
5V/div.
CH3: V_{sw}
5V/div.
CH4: I_L
5A/div.

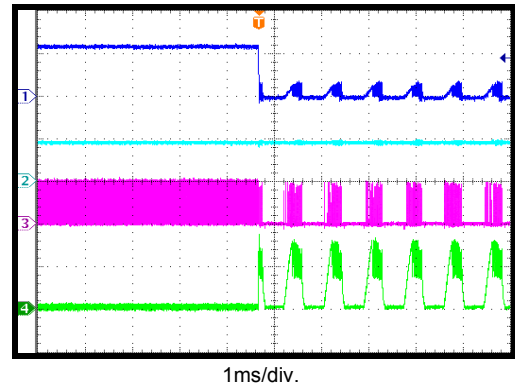

SCP Recovery

$I_{OUT} = 0A$

CH1: V_{OUT}
1V/div.
CH2: V_{IN}
5V/div.
CH3: V_{sw}
5V/div.
CH4: I_L
5A/div.

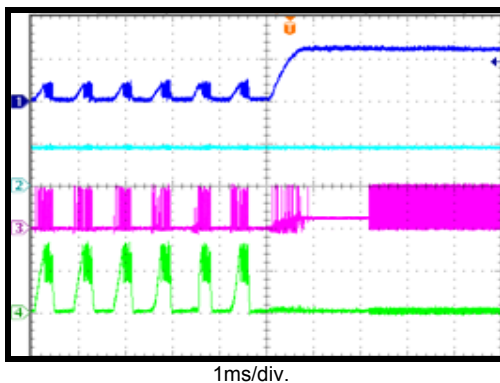

PRINTED CIRCUIT BOARD LAYOUT

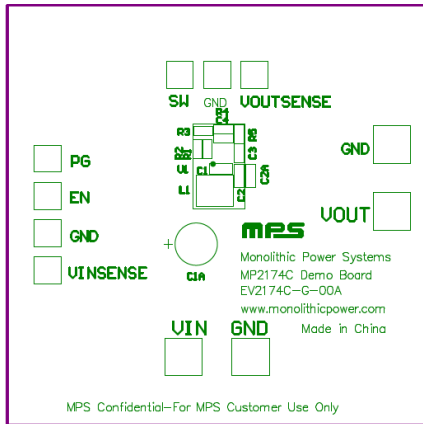

Figure 1: Top Silk Layer

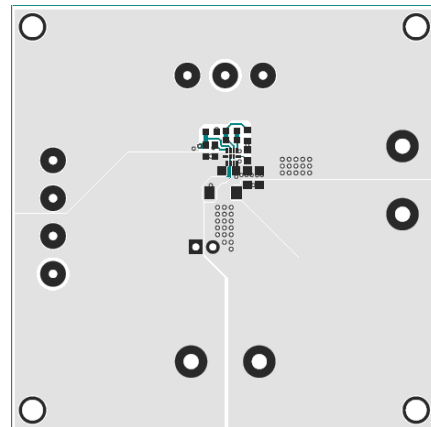

Figure 2: Top Layer

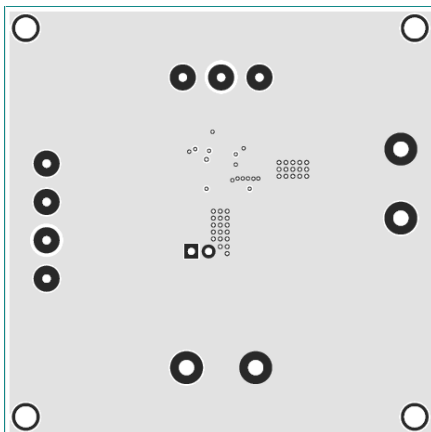

Figure 3: Inner 1 Layer

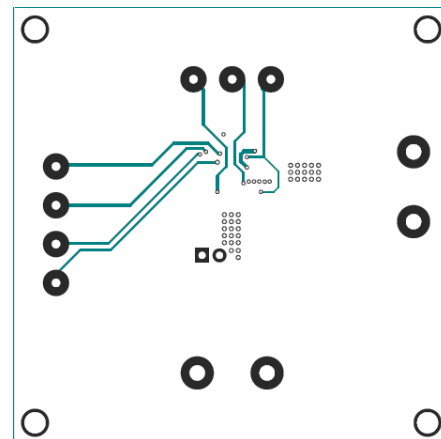

Figure 4: Inner 2 Layer

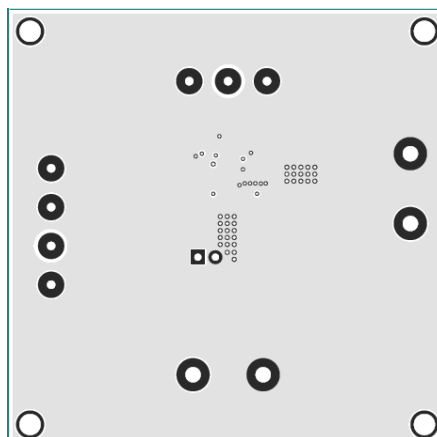

Figure 5: Bottom Layer

QUICK START GUIDE

1. Connect the positive and negative terminals of the load to the VOUT and GND pins, respectively.
2. Preset the power supply output between 2.7V and 5.5V, and then turn off the power supply.
3. Connect the positive and negative terminals of the power supply output to the VIN and GND pins, respectively.
4. Turn the power supply on. The board will automatically start up.
5. To use the Enable function, apply a digital input to the EN pin. Drive EN higher than 1.2V to turn on the regulator or less than 0.4V to turn it off.

LAYOUT RECOMMENDATION OF MP2174C

Proper layout of the switching power supplies is very important, and sometimes critical to make it work properly. Especially, for the high switching converter, if the layout is not carefully done, the regulator could show poor line or load regulation, stability issues.

For MP2174C, the high speed step-down regulator, the input capacitor should be placed as close as possible to the IC pins. As shown in Figure 6, the 0805 size ceramic capacitor is used, please make sure the two ends of the ceramic capacitor be directly connected to PIN1 (the Power Input Pin) and PIN 3 (the Power GND Pin).

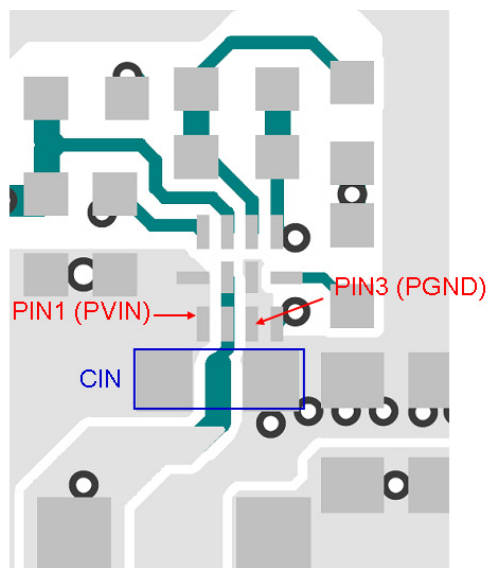

Figure 6: Two ends of Input decoupling Capacitor close to Pin 1 and Pin 3

NOTICE: The information in this document is subject to change without notice. Please contact MPS for current specifications. Users should warrant and guarantee that third party Intellectual Property rights are not infringed upon when integrating MPS products into any application. MPS will not assume any legal responsibility for any said applications.