



The Future of Analog IC Technology®

EV2171-J-00A

1A, 5.5V, 2.6MHz Synchronous Step-Down Switcher Evaluation Board

DESCRIPTION

The EV2171-J-00A is used for demonstrating the performance of MPS's MP/MPQ2171, a low voltage high switching frequency step-down switcher with built in power MOSFETs. MP/MPQ2171 provides up to 1A highly efficient output with constant-on-time control for fast loop response.

MP/MPQ2171 is ideal for powering portable equipment that runs from a single cell Lithium-ion (Li+) Battery. The output voltage can be regulated as low as 0.6V.

High power efficiency over a wide load range is achieved by scaling down the switching frequency at light load to reduce the switching related loss by constant on time control. Short circuit and thermal shutdown provides reliable, fault-tolerant operation.

MP/MPQ2171 is available in TSOT23-8 package.

ELECTRICAL SPECIFICATION

Parameter	Symbol	Value	Units
Input Voltage	V _{IN}	2.5– 5.5	V
Output Voltage	V _{OUT}	1.2	V
Output Current	I _{OUT}	1	A

FEATURES

- Wide 2.5V to 5.5V Operating Input Range
- Up to 1A Output Current
- 40µA Quiescent Current
- 90mΩ and 50mΩ Internal Power MOSFET
- Default 2.6MHz Switching Frequency with 3.3V Input and 1.8V Output
- EN and Power Good for Power Sequencing
- Cycle-by-Cycle Over Current Protection
- Auto Discharge at Power Off
- Short Circuit Protection with Hiccup Mode
- Thermal Shutdown
- Stable with Low ESR Ceramic Output Capacitors
- Internal Soft-Start
- Available in a TSOT23-8 Package
- Available in AEC-Q100 Grade 1

APPLICATIONS

- Automotive Infotainment
- Automotive Clusters
- Automotive Telematics
- Low-Voltage I/O System Power
- Handheld/Battery-Powered Systems

All MPS parts are lead-free, halogen-free, and adhere to the RoHS directive. For MPS green status, please visit the MPS website under Quality Assurance. "MPS" and "The Future of Analog IC Technology" are registered trademarks of Monolithic Power Systems, Inc.

EV2171-J-00A EVALUATION BOARD



(L × W × H) 6.35cm × 6.35cm × 1.2cm

Board Number	MPS IC Number
EV2171-J-00A	MP/MPQ2171DJ

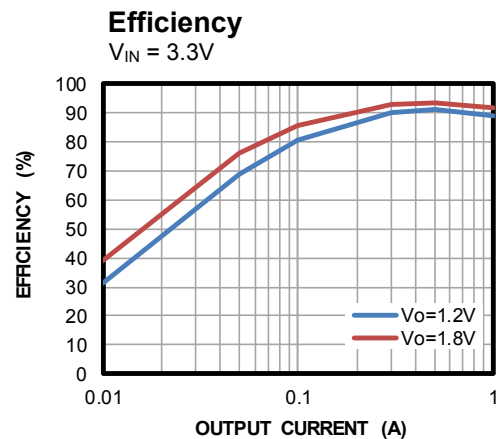

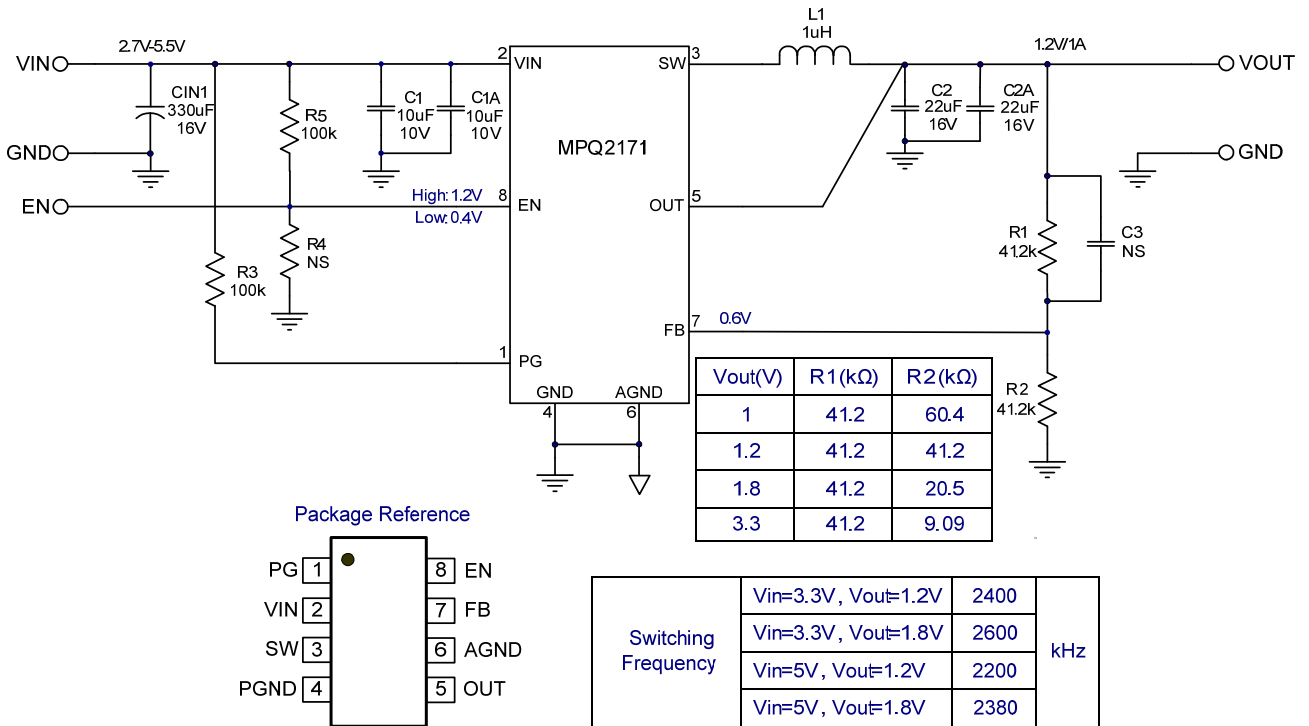
EVALUATION BOARD SCHEMATIC

EV2171-J-00A BILL OF MATERIALS

Qty	Designator	Value	Description	Package	Manufacture	Manufacture_PN
1	CIN1	330 μ F	Electronic Ceramic Cap 10V, 330 μ F, 17m Ω	SMD	Panasonic	10SVP330M
	C2A, C3	NS				
2	C1, C1A	10 μ F	Ceramic Cap 10V, 20%, X5R	1206	Taiyo Yuden	LMK212BJ106MG-T
1	C2	22 μ F	Ceramic Cap 6.3V, 10%, X5R	1206	muRata	GRM218R70J226KE76L
1	L1	1 μ H	Inductor, 6.4A, 8.8m Ω	7.3x6.8mm	TDK	RLF7030-1R0N6R4
		1 μ H	Inductor, 6.4A, 8.4m Ω	7.3x7.3mm	Würth	744777001
		1 μ H	Inductor, 6.4A, 8.8m Ω	5x5mm	Delta	PCMC053T-1R0MN
2	R1,R2	41.2k	Film Res 1%	0603	Yageo	RC0603FR-0741K2L
2	R3,R5	100k	Film Res 1%	0603	Yageo	RC0603FR-074100KL
1	R4	NS				
1	U1		Synchronous Step- Down converter	TSOT23-8	MPS	MPQ2171GJ
4	VIN, VOUT,GND		2.0 Golden Pin		HZ	
9	EN, PG,VINSENSE, VOUTSENSE, SW		1.0 Golden Pin		HZ	

EVB TEST RESULTS

Performance waveforms are tested on the evaluation board.

$V_{IN} = 3.3V$, $V_{OUT} = 1.2V$, $L = 1\mu H$, $C_{OUT} = 22\mu F$, $T_A = +25^\circ C$, unless otherwise noted.

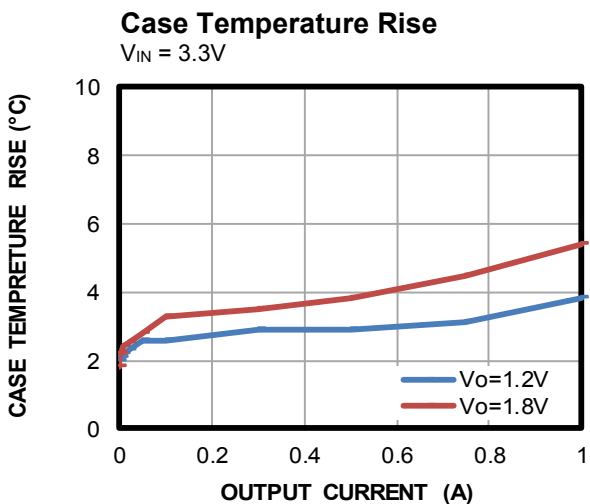
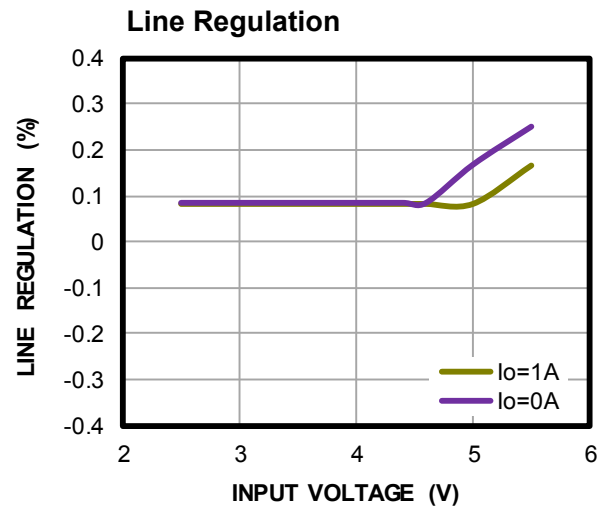
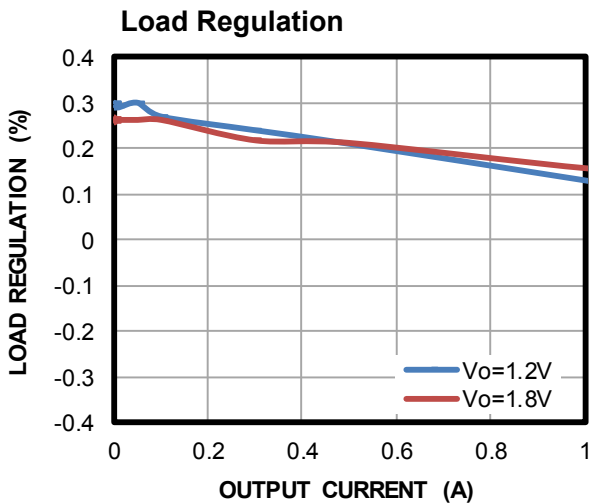
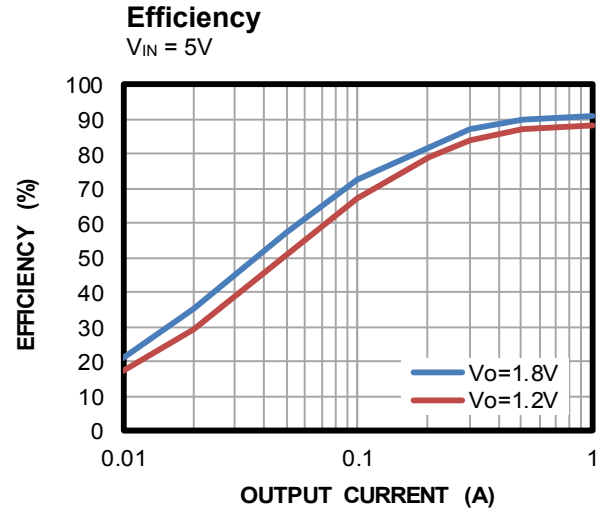
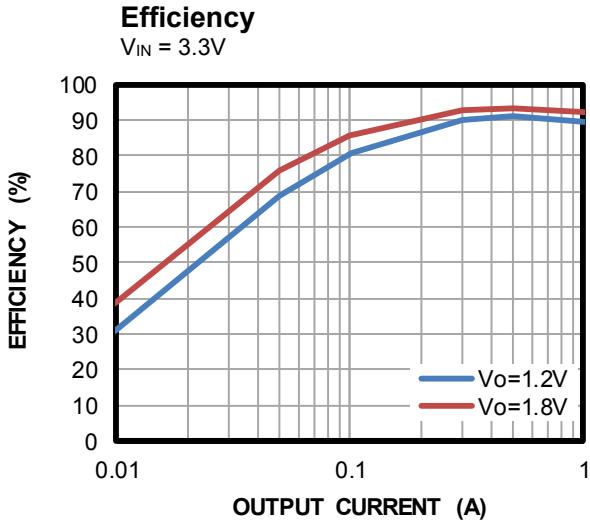

EVB TEST RESULTS (continued)

Performance waveforms are tested on the evaluation board.

 $V_{IN} = 3.3V$, $V_{OUT} = 1.2V$, $L = 1\mu H$, $C_{OUT} = 22\mu F$, $T_A = +25^\circ C$, unless otherwise noted.

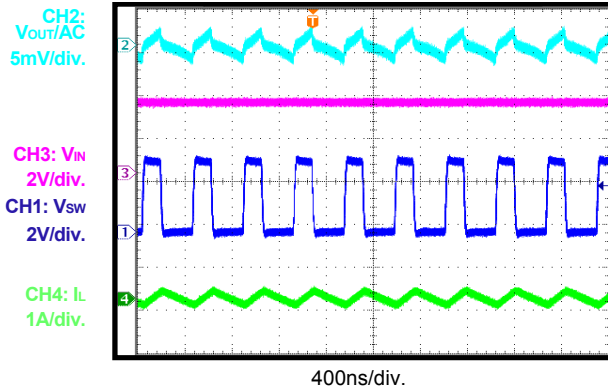
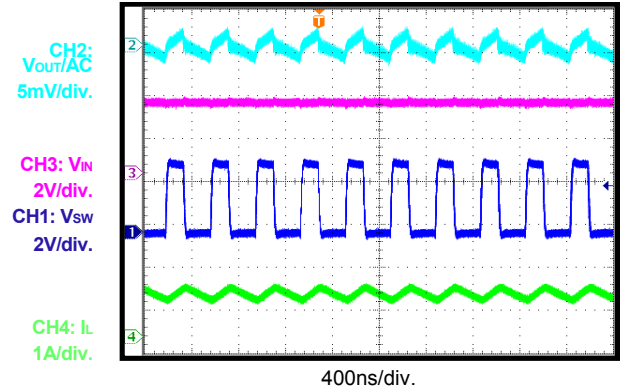
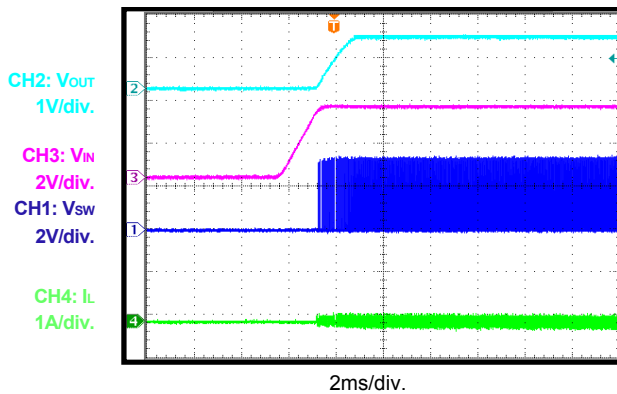
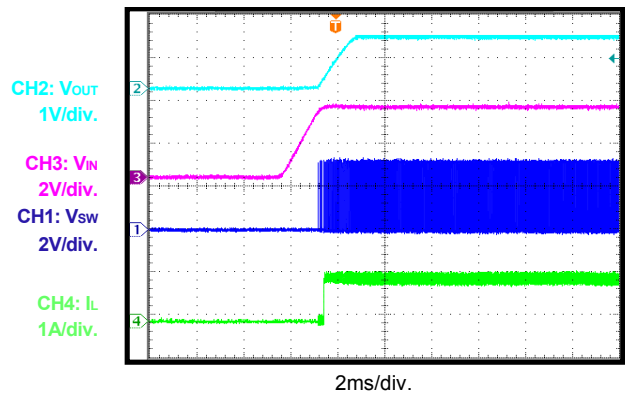
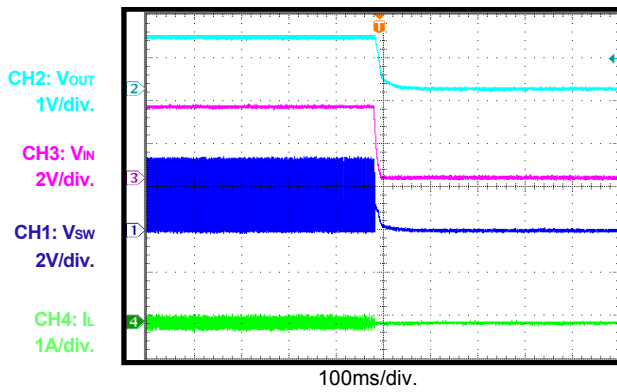
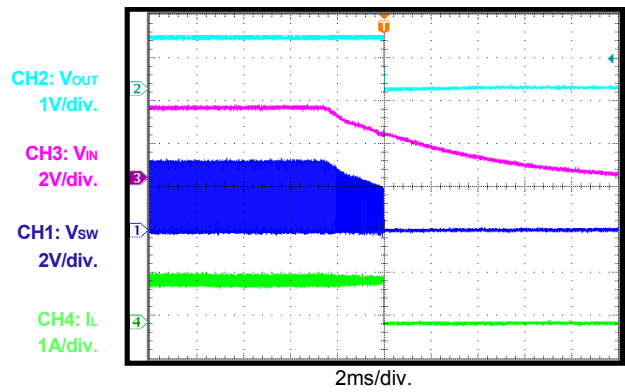
Output Ripple
 $I_{OUT} = 0A$

Output Ripple
 $I_{OUT} = 1A$

Start-Up through V_{IN}
 $I_{OUT} = 0A$

Start-Up through V_{IN}
 $I_{OUT} = 1A$

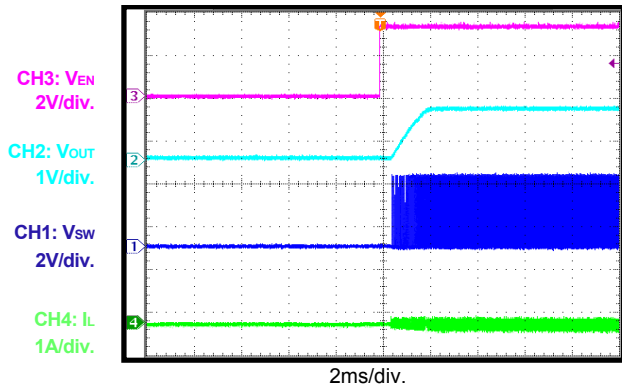
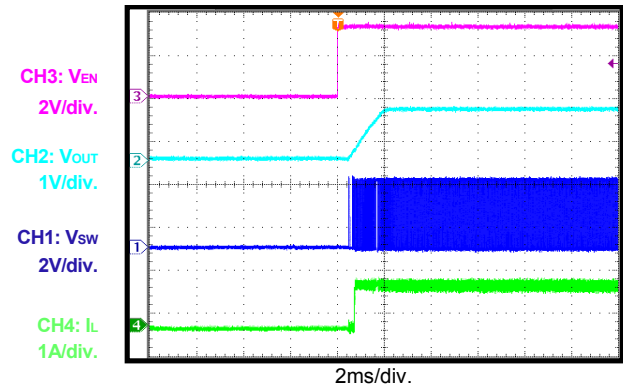
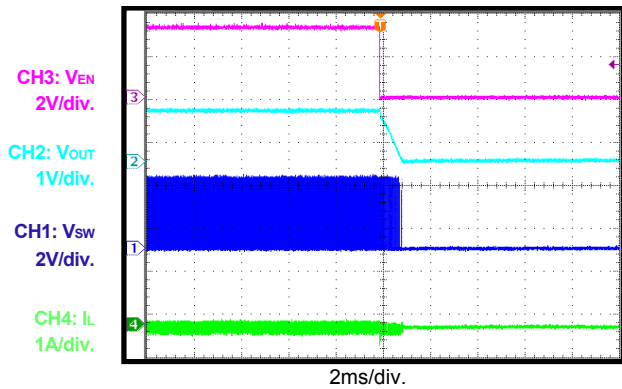
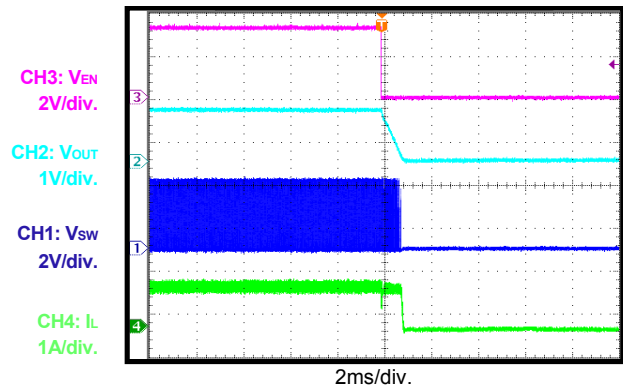
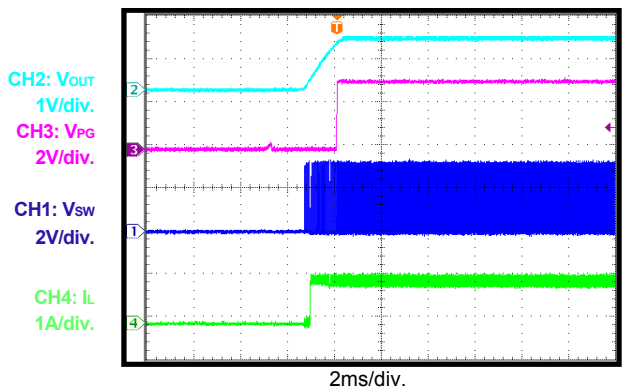
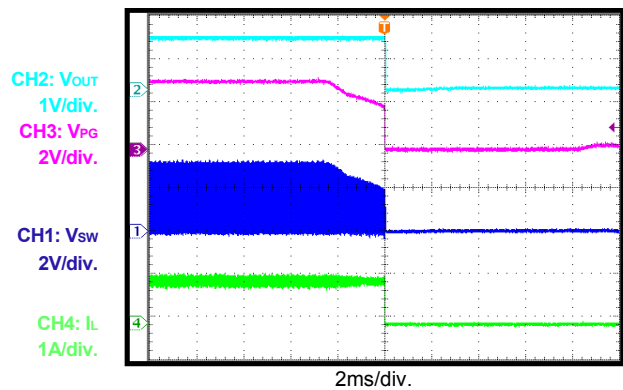
Shutdown through V_{IN}
 $I_{OUT} = 0A$

Shutdown through V_{IN}
 $I_{OUT} = 1A$

EVB TEST RESULTS (continued)

Performance waveforms are tested on the evaluation board.

 $V_{IN} = 3.3V$, $V_{OUT} = 1.2V$, $L = 1\mu H$, $C_{OUT} = 22\mu F$, $T_A = +25^\circ C$, unless otherwise noted.

Start-Up through EN
 $I_{OUT} = 0A$

Start-Up through EN
 $I_{OUT} = 1A$

Shutdown through EN
 $I_{OUT} = 0A$

Shutdown through EN
 $I_{OUT} = 1A$

PG in Start-Up through VIN
 $I_{OUT} = 1A$

PG in Shutdown through VIN
 $I_{OUT} = 1A$

EVB TEST RESULTS *(continued)*

Performance waveforms are tested on the evaluation board.

$V_{IN} = 3.3V$, $V_{OUT} = 1.2V$, $L = 1\mu H$, $C_{OUT} = 22\mu F$, $T_A = +25^\circ C$, unless otherwise noted.

PG in Start-Up through EN

$I_{OUT} = 1A$

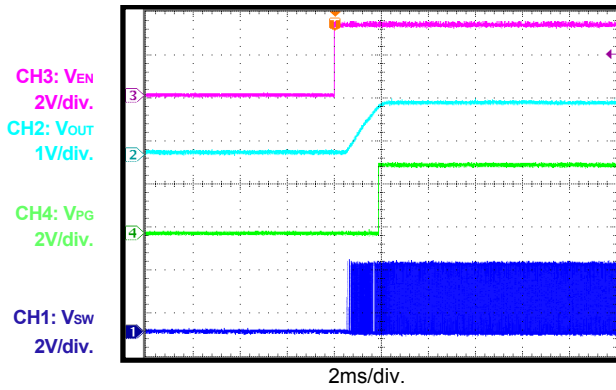

PG in Shutdown through EN

$I_{OUT} = 1A$

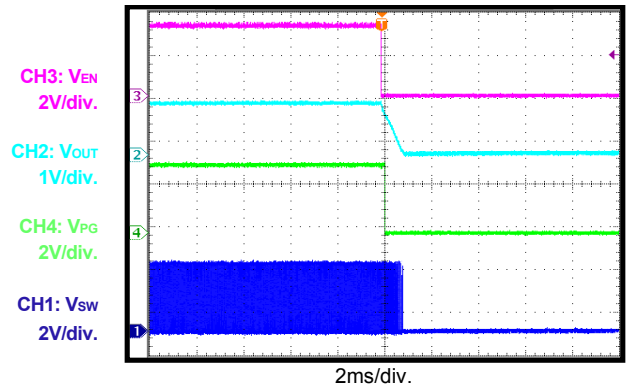

SCP Entry

$I_{OUT} = 0A$

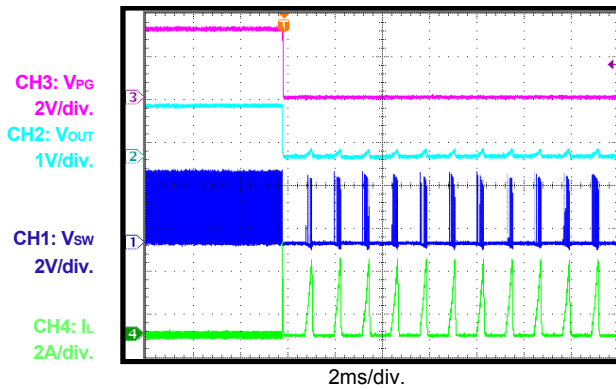

SCP Entry

$I_{OUT} = 1A$

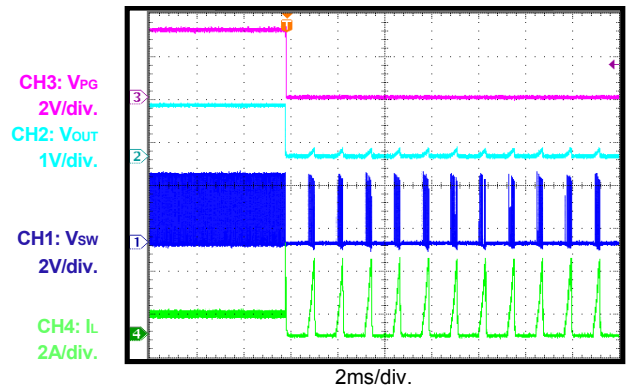

SCP Recovery

$I_{OUT} = 0A$

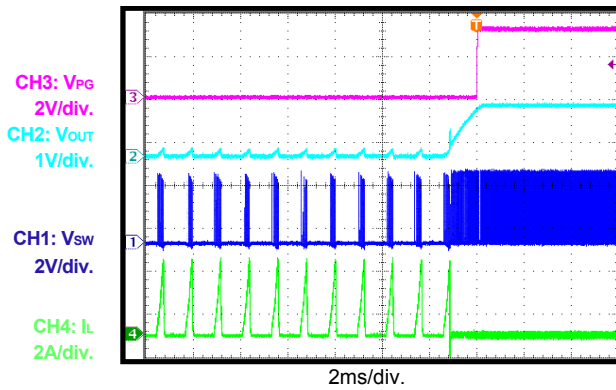

SCP Recovery

$I_{OUT} = 1A$

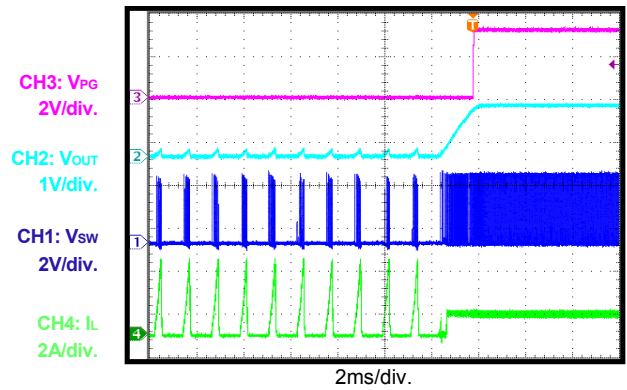

EVB TEST RESULTS *(continued)*

Performance waveforms are tested on the evaluation board.

 $V_{IN} = 3.3V$, $V_{OUT} = 1.2V$, $L = 1\mu H$, $C_{OUT} = 22\mu F$, $T_A = +25^\circ C$, unless otherwise noted.

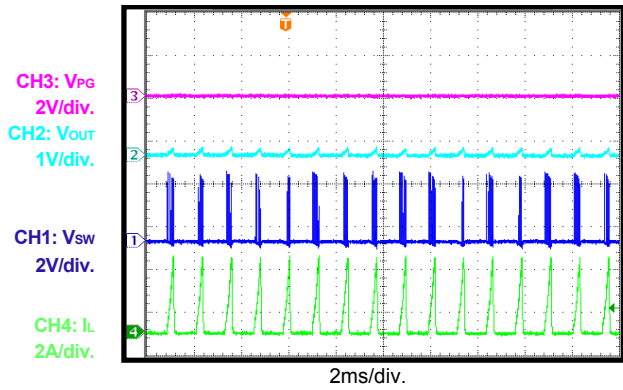
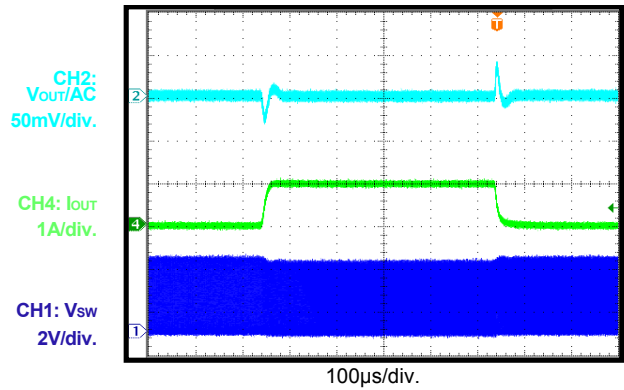
SCP Steady State

Load Transient Response
 $I_{OUT} = 0 - 1A$

PRINTED CIRCUIT BOARD LAYOUT

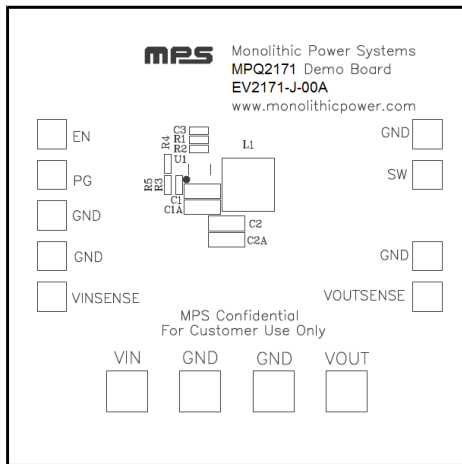

Figure 1—Top Silk Layer

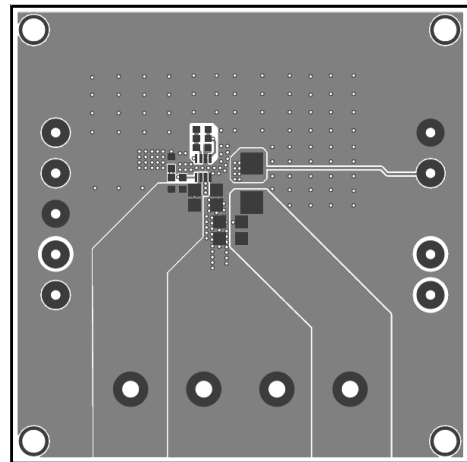

Figure 2—Top Layer

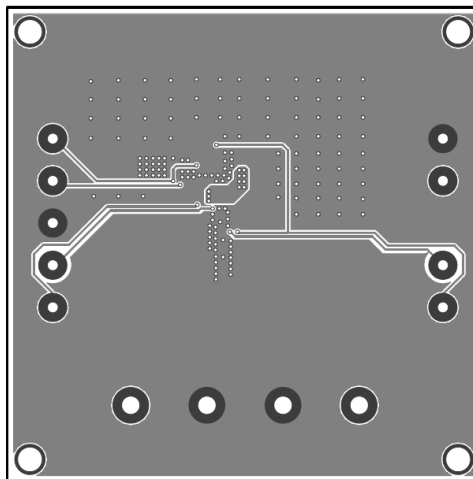

Figure 3— Bottom Layer

QUICK START GUIDE

1. Connect the positive and negative terminals of the load to the VOUT and GND pins, respectively.
2. Preset the power supply output between 2.5V and 5.5V, and then turn off the power supply.
If longer cables are used between the source and the EVB (>0.5m total), a damping capacitor should be installed at the input terminals.
3. Connect the positive and negative terminals of the power supply output to the VIN and GND pins, respectively.
4. Turn the power supply on. The MP/MPQ2171GJ will automatically start up.
5. To use the Enable function, apply a digital input to the EN pin. Drive EN higher than 1.2V to turn on the regulator or less than 0.4V to turn it off.
6. The output voltage is set by the external resistor divider. Choose R1 to be around 41.2kΩ. Then R2 can be calculated with below equation:

$$R2 = \frac{R1}{\frac{V_{out}}{0.6} - 1}$$

The feedback circuit is shown in below Figure:

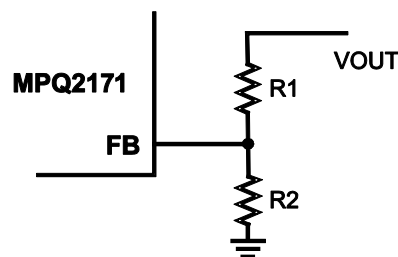

Below table lists the recommended feedback resistor values for common output voltages.

V _{OUT} (V)	R1 (kΩ)	R2 (kΩ)
1.0	41.2 (1%)	60.4 (1%)
1.2	41.2 (1%)	41.2 (1%)
1.8	41.2 (1%)	20.5(1%)
3.3	41.2 (1%)	9.09(1%)

NOTICE: The information in this document is subject to change without notice. Please contact MPS for current specifications. Users should warrant and guarantee that third party Intellectual Property rights are not infringed upon when integrating MPS products into any application. MPS will not assume any legal responsibility for any said applications.