

DESCRIPTION

The EV2131-G-00A is used for demonstrating the performance of MPS's MP2131, a low voltage high switching frequency step-down switcher with built in power MOSFETs. MP2131 provides up to 4A highly efficient output with constant-on-time control for fast loop response.

MP2131 is ideal for powering portable equipment that runs from a single cell Lithium-ion (Li+) Battery. The output voltage can be regulated as low as 0.6V.

High power efficiency over a wide load range is achieved by scaling down the switching frequency at light load to reduce the switching related loss by constant on time control. Short circuit and thermal shutdown provides reliable, fault-tolerant operation.

MP2131 is available in QFN12 (2x2mm) package.

ELECTRICAL SPECIFICATION

Parameter	Symbol	Value	Units
Input Voltage	V_{IN}	2.7– 5.5	V
Output Voltage	V_{OUT}	1.2	V
Output Current	I_{OUT}	4	A

FEATURES

- Wide 2.7V to 5.5V Operating Input Range
- Up to 4A Output Current
- 19 μ A Quiescent Current
- 32m Ω and 17m Ω Internal Power MOSFET
- 1.2MHz CCM Switching Frequency
- EN and Power Good for Power Sequencing
- Cycle-by-Cycle Over Current Protection
- Auto Discharge at Power Off
- Short Circuit Protection with Hiccup Mode
- Thermal Shutdown
- Stable with Low ESR Ceramic Output Capacitors
- Internal Soft-Start
- Available in a QFN12 (2x2mm) Package

APPLICATIONS

- Storage Drives
- Portable/Handheld Devices
- Wireless/Networking Cards
- Low Voltage I/O System Power

For MPS green status, please visit MPS website under Quality Assurance. "MPS" and "The Future of Analog IC Technology", are Registered Trademarks of Monolithic Power Systems, Inc.

ADAM (Analog Digital Adaptive Modulation), AAM (...) are Trademarks of Monolithic Power Systems, Inc.

The MP#### is covered by US Patents #,###,###, #,###,###, #,###,###.

EV2131-G-00A EVALUATION BOARD



Board Number	MPS IC Number
EV2131-G-00A	MP2131GG

Efficiency vs. Output Current

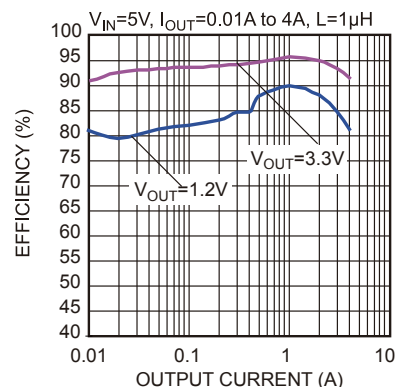

EVALUATION BOARD SCHEMATIC

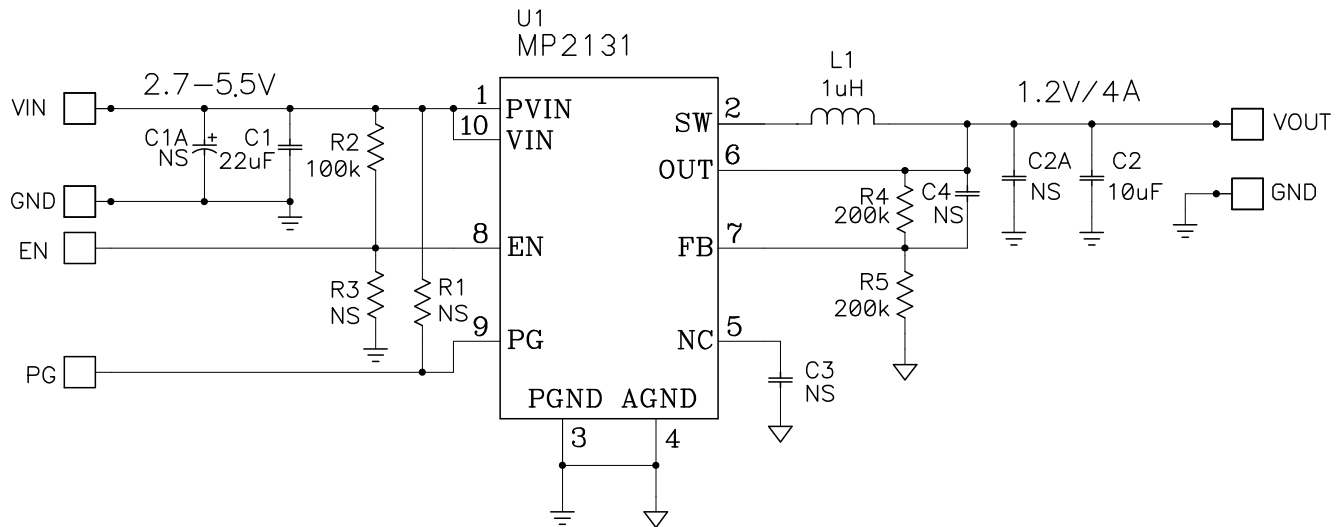

EV2131-G-00A BILL OF MATERIALS

Qty	RefDes	Value	Description	Package	Manufacturer	Manufacturer P/N
	C1A,C2A, C3,C4	NS				
1	C1	22 μ F	Ceramic Cap., 10V, 20%, X5R	0805	Taiyo Yuden	LMK212BJ226MG-T
1	C2	10 μ F	Ceramic Cap., 6.3V, 10%, X5R	0805	muRata	GRM21BR70J106KE76L
1	L1	1.0 μ H	Inductor, I _S = 9A, DCR=27m Ω	SMD	Würth	74437324010
	R1	NS				
1	R2	100k	Film Res., 5%	0603	Yageo	RC0603JR-07100KL
	R3	NS				
2	R4,R5	200k	Film Res., 5%	0603	Yageo	RC0603JR-07200KL
1	U1	MP2131	Synchronous Step-Down switcher	QFN12- 2x2mm	MPS	MP2131GG

EVB TEST RESULTS

Performance waveforms are tested on the evaluation board.

$V_{IN} = 5V$, $V_{OUT} = 1.2V$, $L = 1.0\mu H$, $T_A = 25^\circ C$, unless otherwise noted.

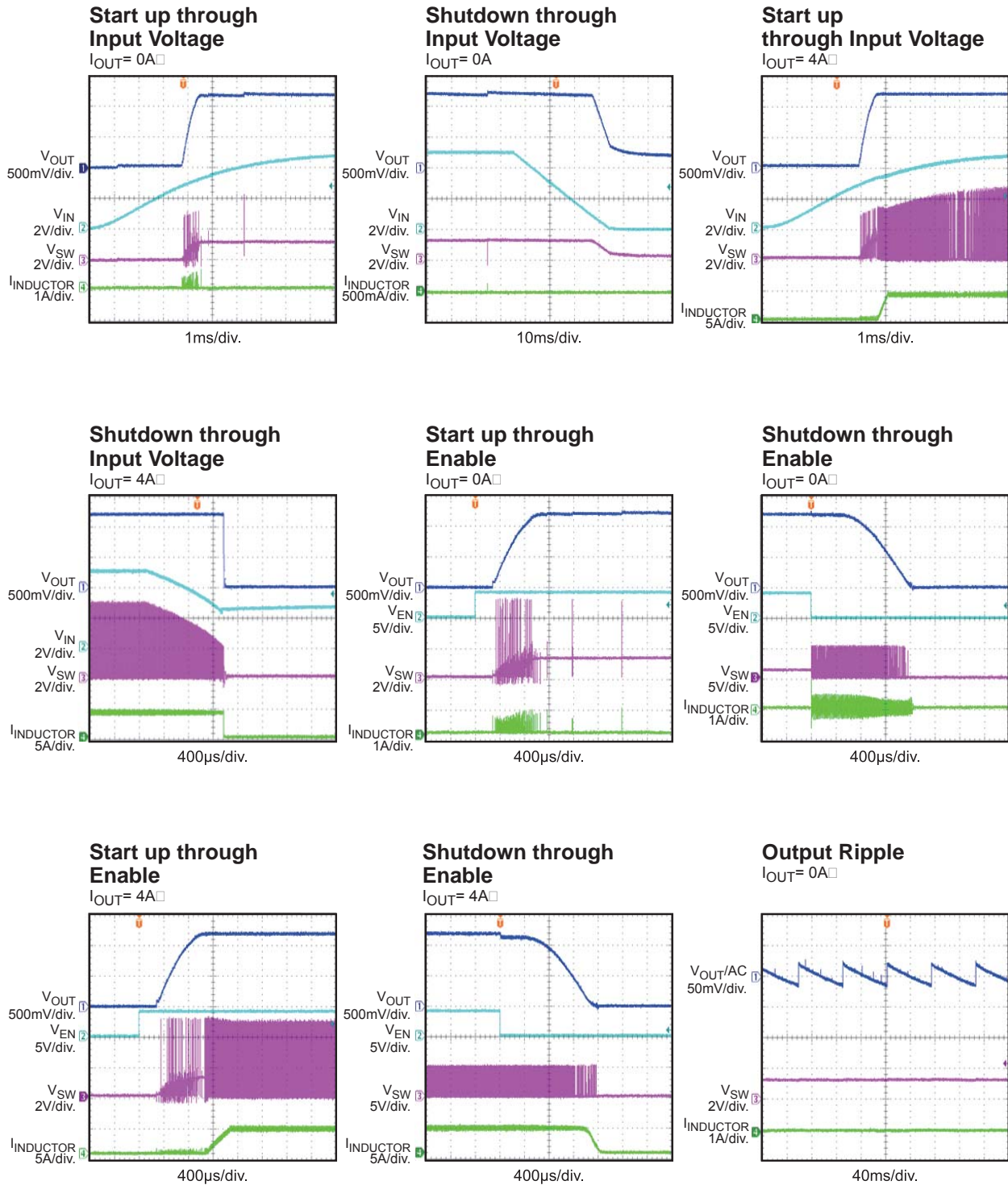

EVB TEST RESULTS (continued)

Performance waveforms are tested on the evaluation board.

 $V_{IN} = 5V$, $V_{OUT} = 1.2V$, $L = 1.0\mu H$, $T_A = 25^\circ C$, unless otherwise noted.

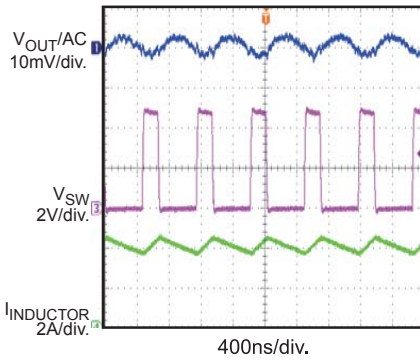
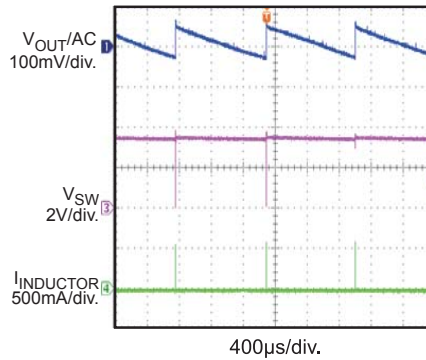
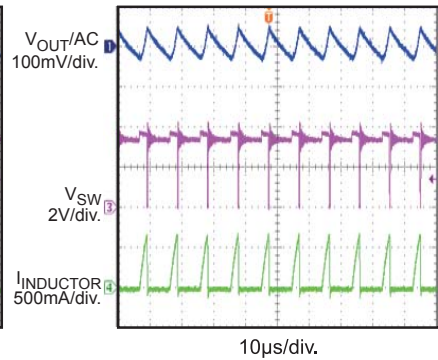
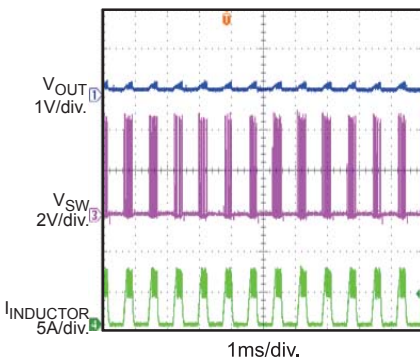
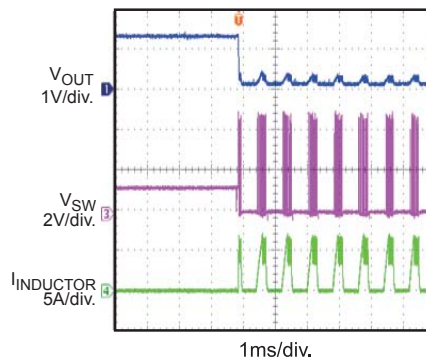
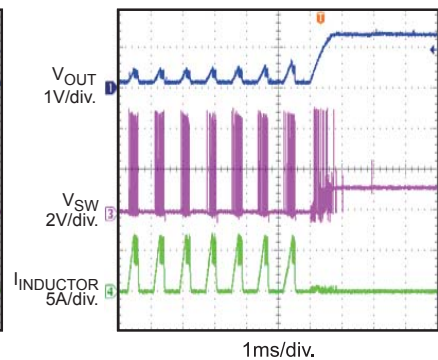
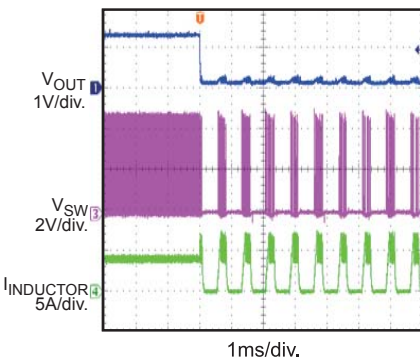
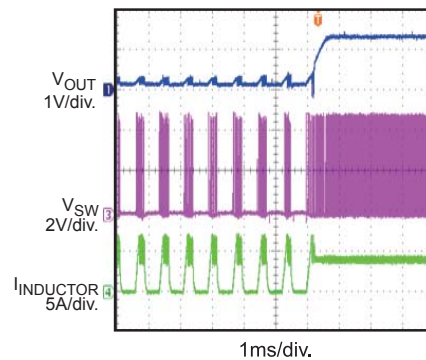
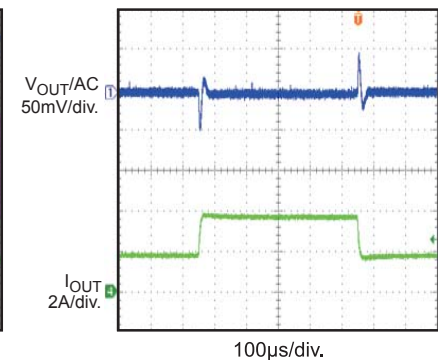
Output Ripple
 $I_{OUT} = 4A$

Output Ripple
 $V_{IN} = 3.6V$, $V_{OUT} = 3.3V$, $I_{OUT} = 0A$

Output Ripple
 $V_{IN} = 3.6V$, $V_{OUT} = 3.3V$, $I_{OUT} = 0.1A$

Short Circuit Steady State

Short Circuit Entry
 $I_{OUT} = 0A$

Short Circuit Recovery
 $I_{OUT} = 0A$

Short Circuit Entry
 $I_{OUT} = 4A$

Short Circuit Recovery
 $I_{OUT} = 4A$

Transient Response
 $I_{OUT} = 2A$ to $4A$, $2.5A/\mu s$

PRINTED CIRCUIT BOARD LAYOUT

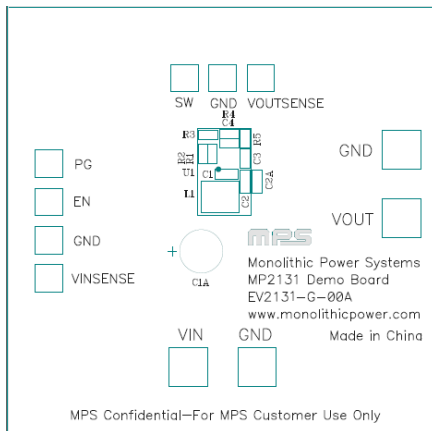

Figure 1—Top Silk Layer

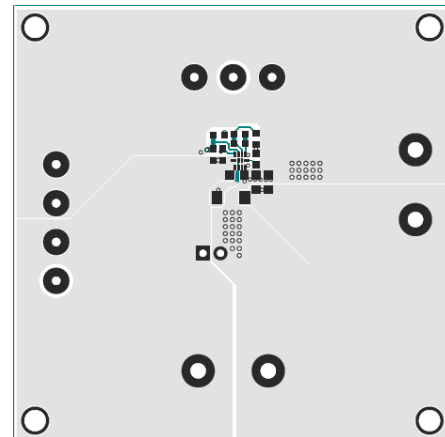

Figure 2—Top Layer

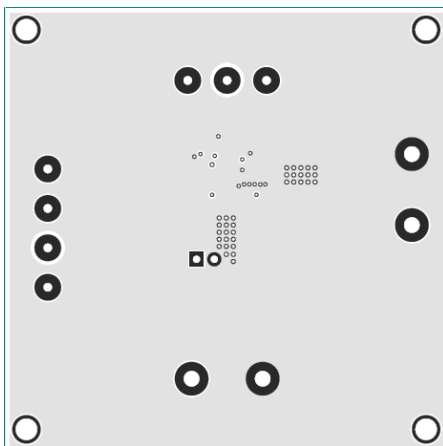

Figure 3—Inner 1 Layer

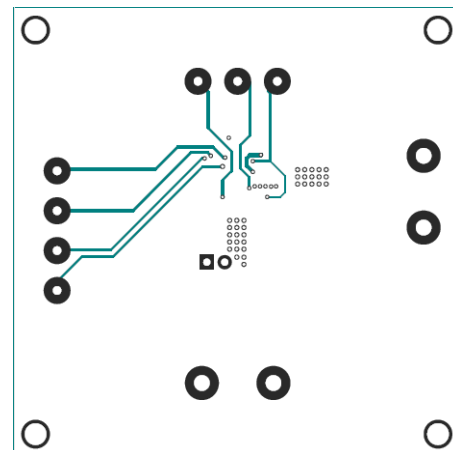

Figure 4—Inner 2 Layer

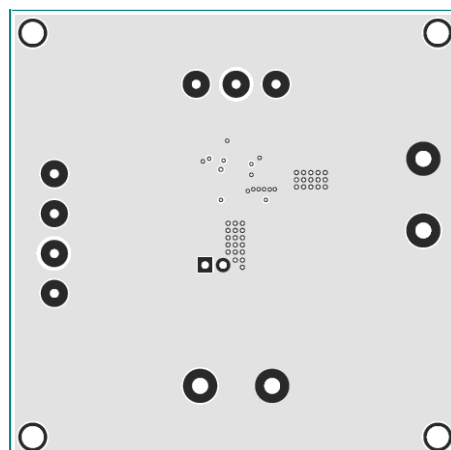

Figure 5—Bottom Layer

QUICK START GUIDE

1. Connect the positive and negative terminals of the load to the VOUT and GND pins, respectively.
2. Preset the power supply output between 2.7V and 5.5V, and then turn off the power supply.
3. Connect the positive and negative terminals of the power supply output to the VIN and GND pins, respectively.
4. Turn the power supply on. The board will automatically start up.
5. To use the Enable function, apply a digital input to the EN pin. Drive EN higher than 1.2V to turn on the regulator or less than 0.4V to turn it off.

LAYOUT RECOMMENDATION OF MP2131

Proper layout of the switching power supplies is very important, and sometimes critical to make it work properly. Especially, for the high switching converter, if the layout is not carefully done, the regulator could show poor line or load regulation, stability issues.

For MP2131, the high speed step-down regulator, the input capacitor should be placed as close as possible to the IC pins. As shown in Figure 6, the 0805 size ceramic capacitor is used, please make sure the two ends of the ceramic capacitor be directly connected to PIN1 (the Power Input Pin) and PIN 3 (the Power GND Pin).

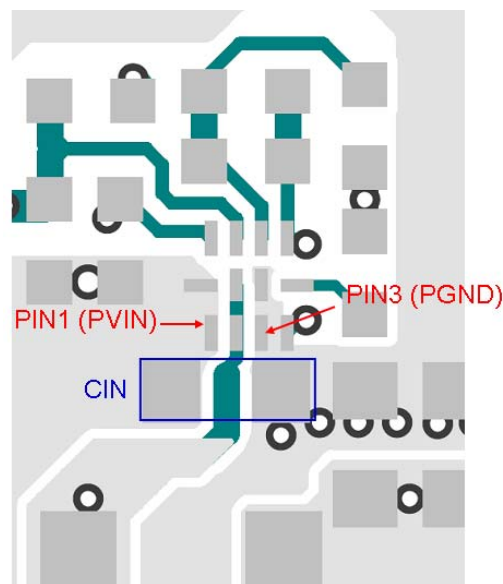

Figure 6— Two ends of Input decoupling Capacitor close to Pin 1 and Pin 3

NOTICE: The information in this document is subject to change without notice. Please contact MPS for current specifications. Users should warrant and guarantee that third party Intellectual Property rights are not infringed upon when integrating MPS products into any application. MPS will not assume any legal responsibility for any said applications.