

### DESCRIPTION

The EV2015A-J\_Q\_G-00A is an evaluation board for the MP2015A, a low linear regulator that supplies power to systems with high voltage batteries.

MP2015A includes a wide 2.5V to 24V input range, low dropout voltage and low quiescent supply current. The low quiescent current and low dropout voltage allow operations at extremely low power levels. Therefore, the MP2015A is an ideal for the low power microcontrollers and the battery-powered equipments.

The EV2015A-J\_Q\_G-00A is a fully assembled and tested evaluation board. It generates a +5V output voltage at load current up to 150mA from a 6V to 24V input range.

### ELECTRICAL SPECIFICATIONS

Parameter	Symbol	Value	Units
Input Voltage	$V_{IN}$	6 – 24	V
Output Voltage	$V_{OUT}$	5	V
Output Current	$I_{OUT}$	150	mA

### FEATURES

- 2.5V to 24V Input Range
- 3.3µA Quiescent Supply Current
- Stable With low-value output ceramic capacitor (> 0.47µF)
- 150mA specified current
- 700mV Dropout at 150mA Load
- Available in Fixed 3.3V Output and Adjustable Output (1.215V to 15V) versions
- Output ±2% Accuracy
- Specified current limit
- Thermal Shutdown and Short-Circuit Protection
- Available in TSOT23-5, QFN-6 (2mmx2mm), or QFN-8 (3mmx3mm) Packages

### APPLICATIONS

- Portable/Battery-Powered Equipment
- Ultra low power Microcontrollers
- Cellular Handsets

All MPS parts are lead-free and adhere to the RoHS directive. For MPS green status, please visit MPS website under Products, Quality Assurance page.

"MPS" and "The Future of Analog IC Technology" are registered trademarks of Monolithic Power Systems, Inc.

## EV2015A-J\_Q\_G-00A EVALUATION BOARD



(L x W x H) 2.5" x 2.5" x 0.4"  
(6.4cm x 6.4cm x 1.0cm)

Board Number	MPS IC Number
EV2015A-J_Q_G-00A	MP2015A-GJ/GQ/GG

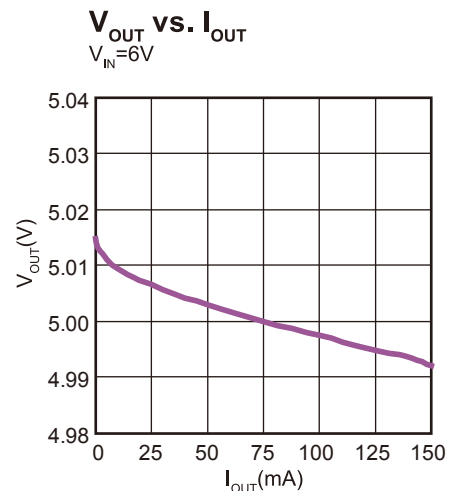

## EVALUATION BOARD SCHEMATIC

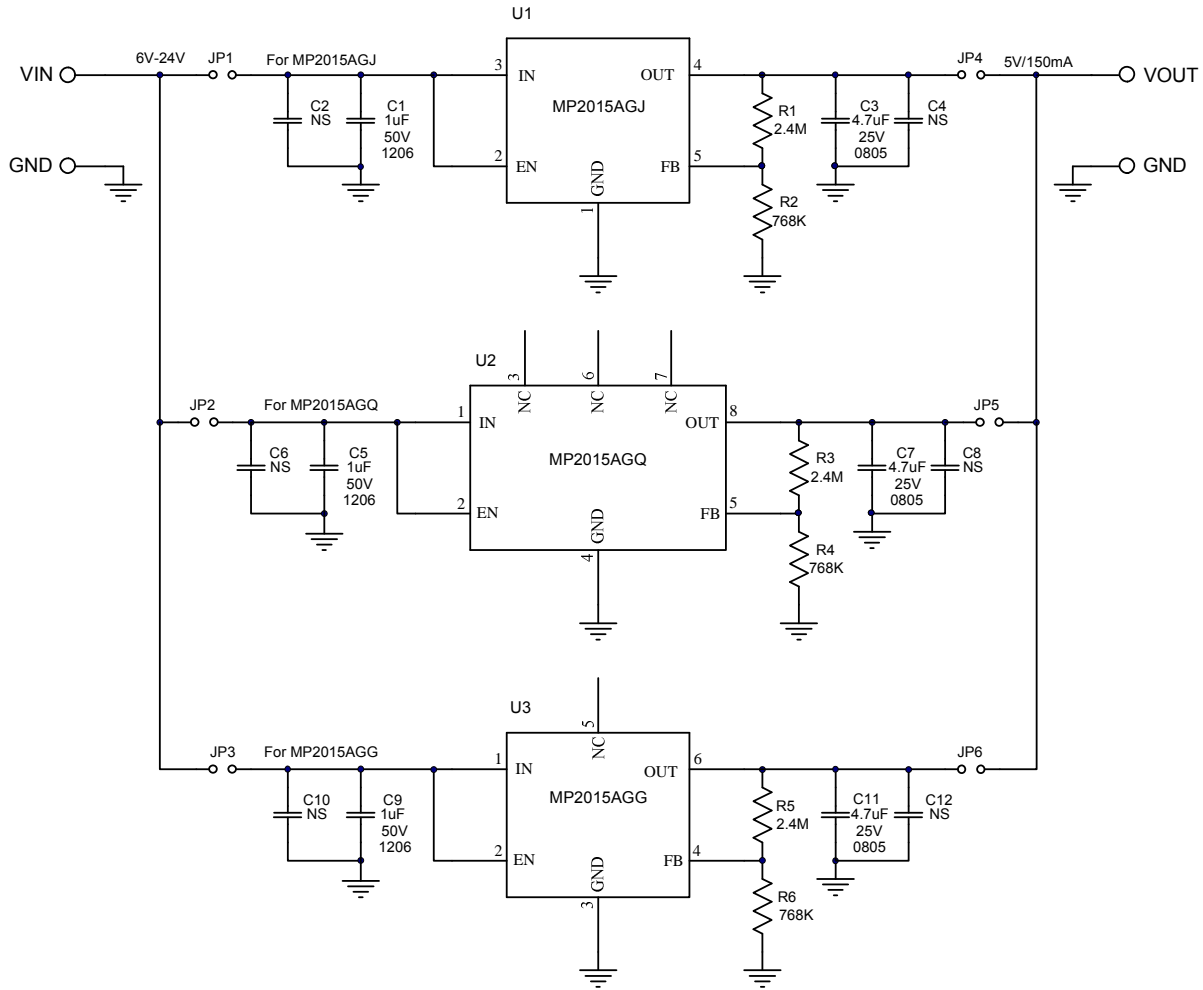

## EV2015A-J\_Q\_G-00A BILL OF MATERIALS

Qty	RefDes	Value	Description	Package	Manufacturer	Manufacturer_P/N
3	C1, C5, C9	1 $\mu$ F	Ceramic Cap., 50V, X7R	1206	muRata	GRM31MR71H105KA88L
3	C3, C7, C11	4.7 $\mu$ F	Ceramic Cap., 25V, X5R	0805	muRata	GRM21BR61E475KA12L
0	C2, C4, C6, C8, C10, C12	NS				
3	R1, R3, R5	2.4M	Film Res., 1%	0603	Yageo	RC0603FR-072M4L
3	R2, R4, R6	768k	Film Res., 1%	0603	Yageo	RC0603FR-07768KL
6	JP1, JP2, JP, JP4, JP5, JP6		Jumper			
1	U1	MP2015AGJ		TSOT23-5	MPS	MP2015AGJ
1	U2	MP2015AGQ		QFN8-3x3	MPS	MP2015AGQ
1	U3	MP2015AGG		QFN6-2x2	MPS	MP2015AGG

## EVB TEST RESULTS

Performance waveforms are tested on the evaluation board.

$V_{OUT} = 5V$ ,  $T_A = 25^\circ C$ , unless otherwise noted.

**Dropout Voltage vs. Junction Temperature**  
 $V_{OUT} = 5V$

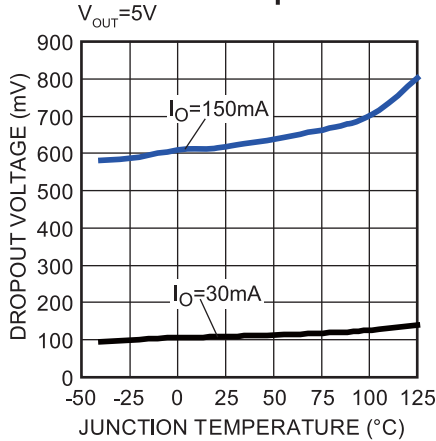

**Feedback Voltage vs. Junction Temperature**  
 $V_{IN} = 6V$

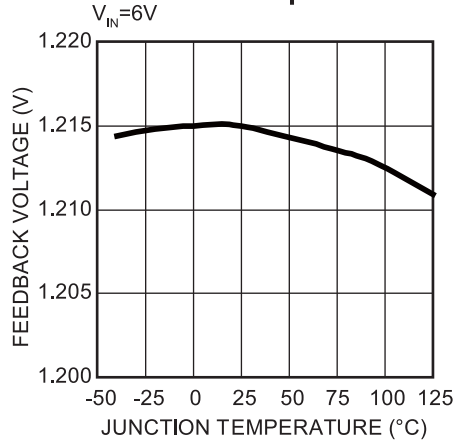

**Current Limit vs. Junction Temperature**  
 $V_{IN} = 6V$

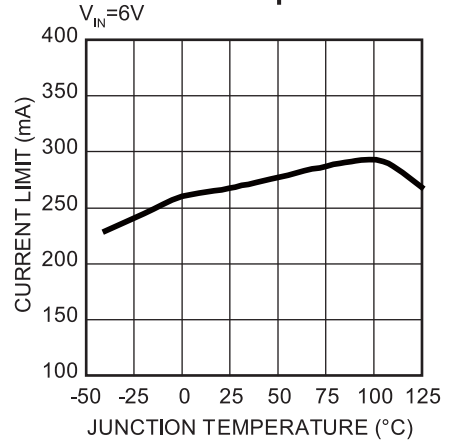

### EVB TEST RESULTS *(continued)*

Performance waveforms are tested on the evaluation board.

$V_{OUT} = 5V$ ,  $T_A = 25^\circ C$ , unless otherwise noted.

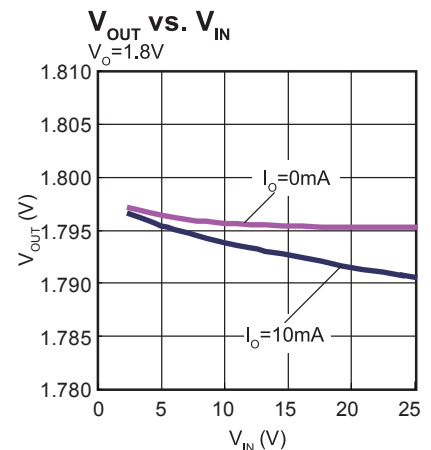
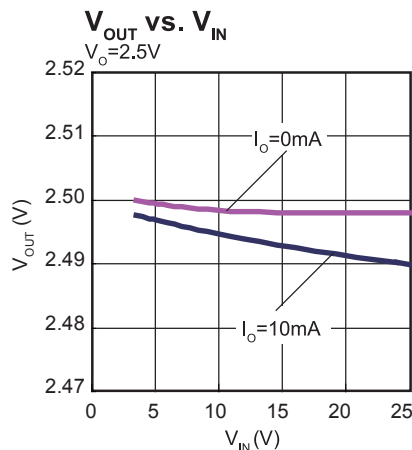
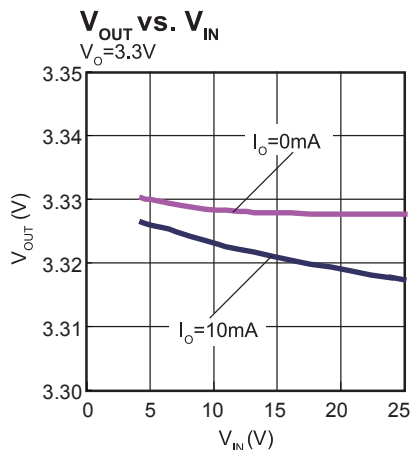
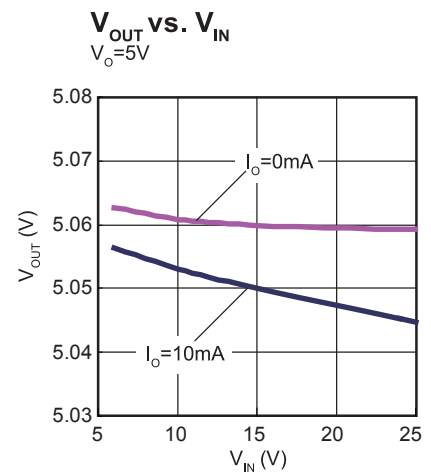
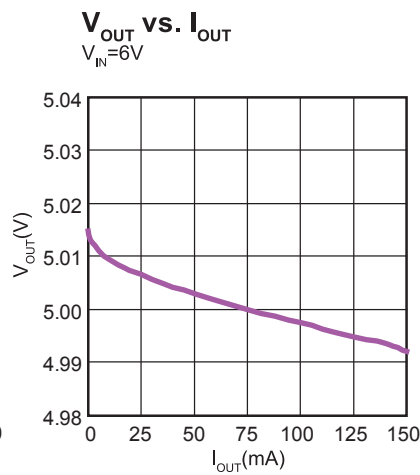
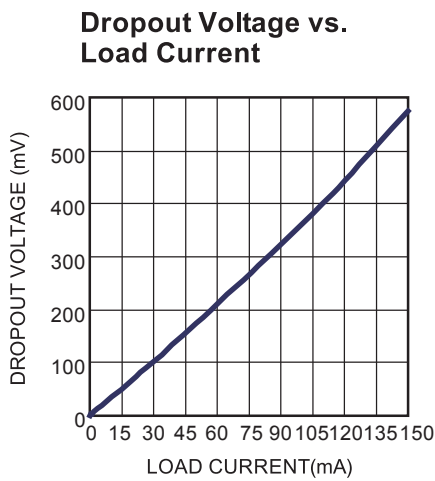
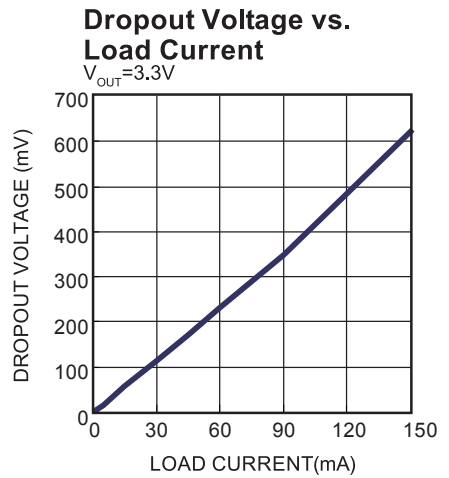
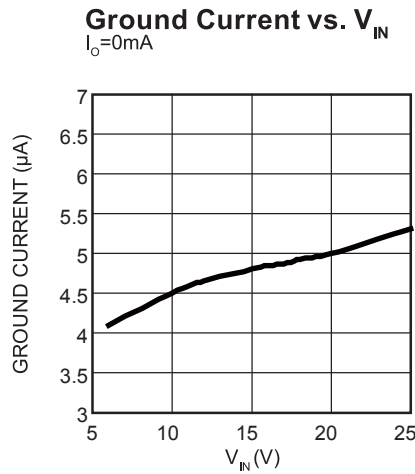
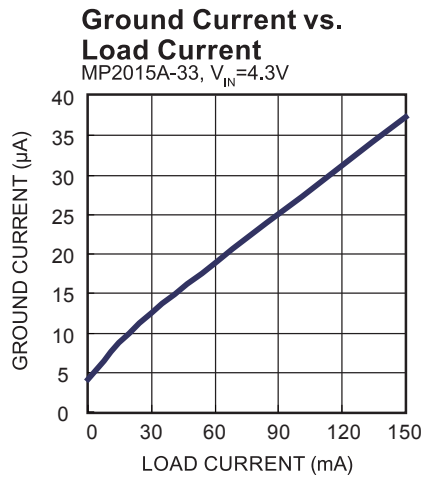

## EVB TEST RESULTS (continued)

Performance waveforms are tested on the evaluation board.

$V_{OUT} = 5V$ ,  $T_A = 25^\circ C$ , unless otherwise noted.

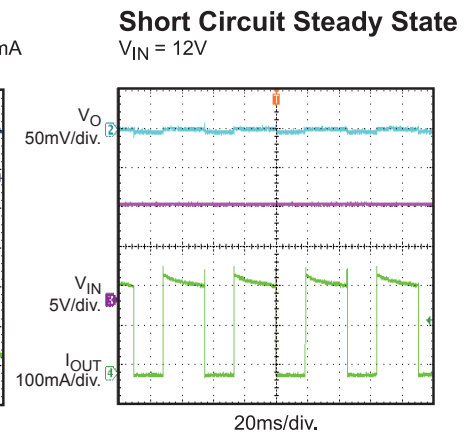
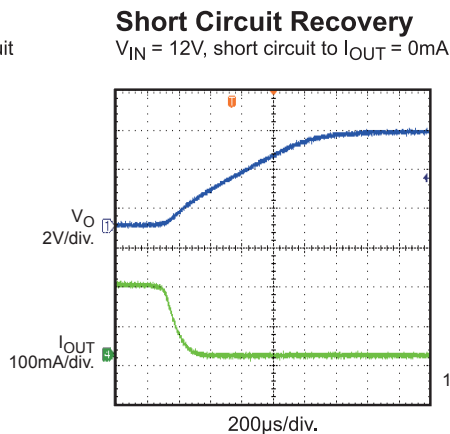
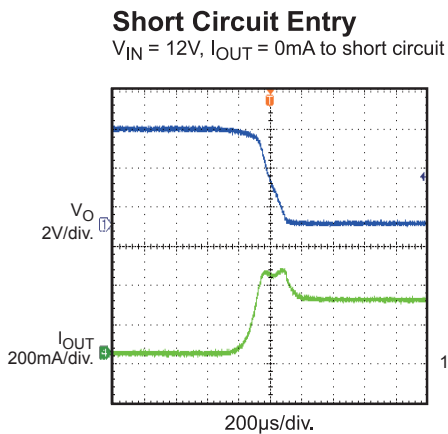
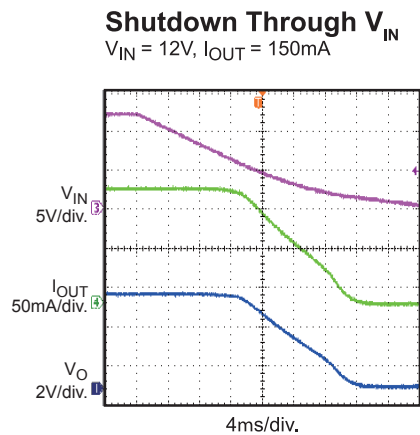
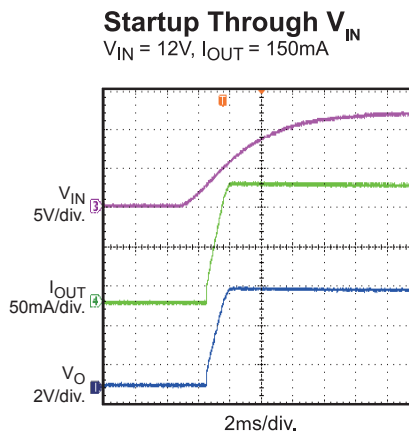
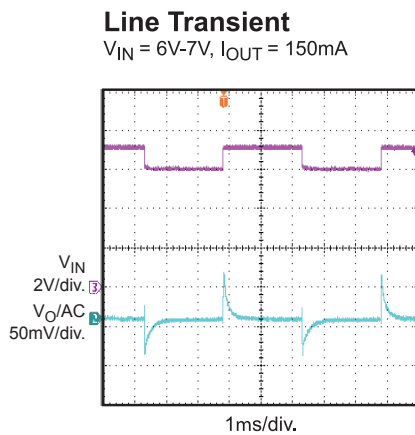
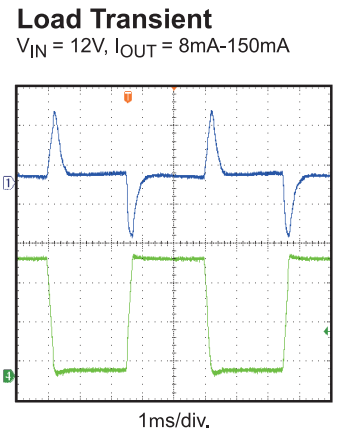
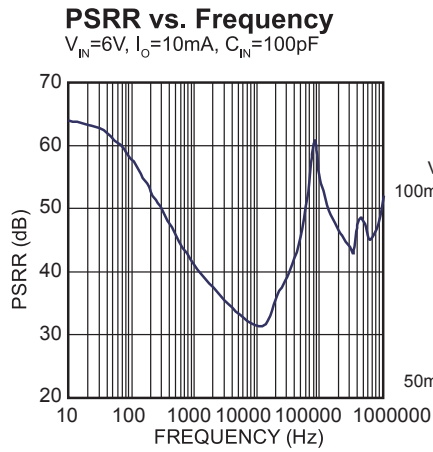
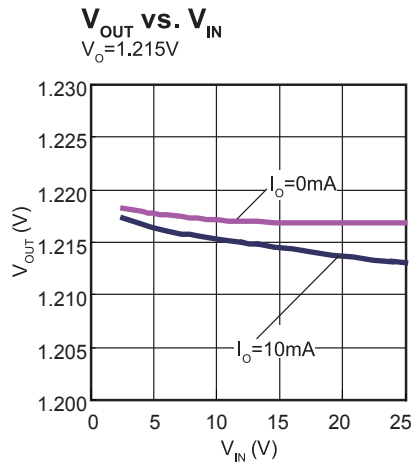

### PRINTED CIRCUIT BOARD LAYOUT

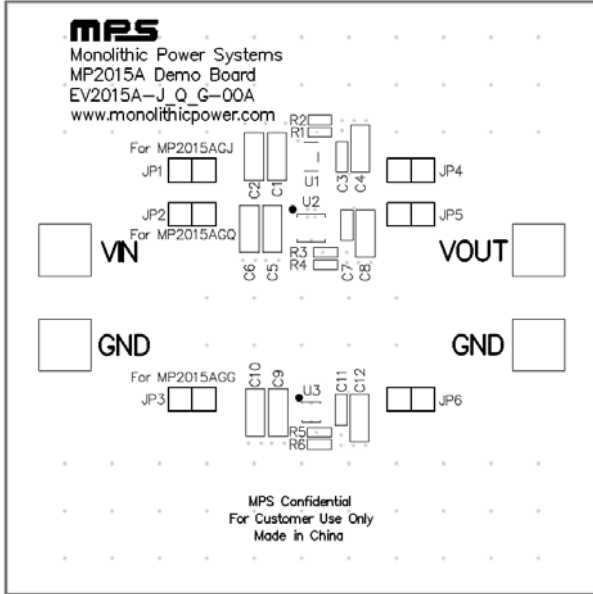

Figure 1—Top Silk Layer

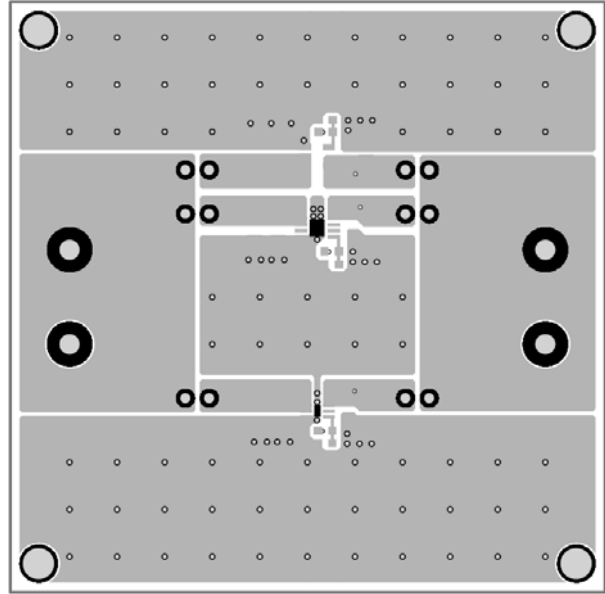

Figure 2—Top Layer

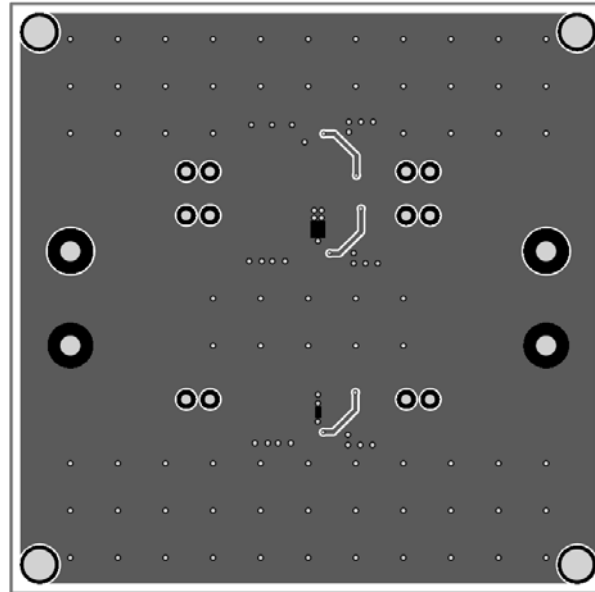

Figure 3—Bottom Layer

## QUICK START GUIDE

1. Connect different jumpers to select different MP2015A ICs with different packages for evaluation:

Connected Jumpers	Selected IC
JP1, JP4	MP2015AGJ
JP2, JP5	MP2015AGQ
JP3, JP6	MP2015AGG

2. Connect the positive and negative terminals of the load to the VOUT and GND pins, respectively.
3. Preset the power supply output between 6V and 24V, and then turn it off.
4. Connect the positive and negative terminals of the power supply output to the VIN and GND pins, respectively.
5. Turn the power supply on. The MP2015A will automatically startup.
6. To lower the additional current dissipation, resistors of FB divider on the demo board are chosen to high value. If part would operate under no load, FB dividers should be lower to maintain a minimum load to draw the leakage current from OUT pin. The recommend value of R2/R4/R6 is 1MΩ in room temperature. When part is working in high temperature, the recommended maxim value of R2/R4/R6 is 506kΩ when  $T_a \leq 105^\circ\text{C}$  and 173kΩ when  $T_a \leq 125^\circ\text{C}$ . Once R2/R4/R6 is determined, R1/R3/R5 can be calculated by below formula (take R1 as an example):

$$R1 = R2 \times \left( \frac{V_{OUT}}{1.215V} - 1 \right)$$

**NOTICE:** The information in this document is subject to change without notice. Users should warrant and guarantee that third party Intellectual Property rights are not infringed upon when integrating MPS products into any application. MPS will not assume any legal responsibility for any said applications.