

DESCRIPTION

The EV1924A-R-00A is an evaluation board for the MP1924A, a high-frequency, half-bridge gate driver. Its high-side and low-side driver channels are independently controlled, and are matched with a time delay of less than 5ns.

The board is configured as a buck converter. The INH and INL signals are independent of each other. Complementary PWMs with proper dead time should be implemented for INH and INL.

ELECTRICAL SPECIFICATIONS

Parameter	Symbol	Value	Units
Driver power supply voltage	V _{DD}	8 to 15	V
Input power supply voltage	V _{IN}	0 to 100	V

FEATURES

- 115V Bootstrap Voltage Range
- On-Chip Bootstrap Diode
- Quiescent Current Below 150µA
- Typical Propagation Delay of 20ns
- Gate Driver Matching of Less than 5ns
- UVLO for Both High-Side and Low-Side Gate Drivers
- TTL-Compatible Input
- Available in QFN-10 (4mmx4mm) and SOIC-8 Packages

APPLICATIONS

- Motor Drivers
- Telecom Half-Bridge Power Supplies
- Avionics DC/DC Converters

All MPS parts are lead-free, halogen-free, and adhere to the RoHS directive. For MPS green status, please visit the MPS website under Quality Assurance. "MPS", the MPS logo, and "Simple, Easy Solutions" are trademarks of Monolithic Power Systems, Inc. or its subsidiaries.

EV1924A-R-00A EVALUATION BOARD

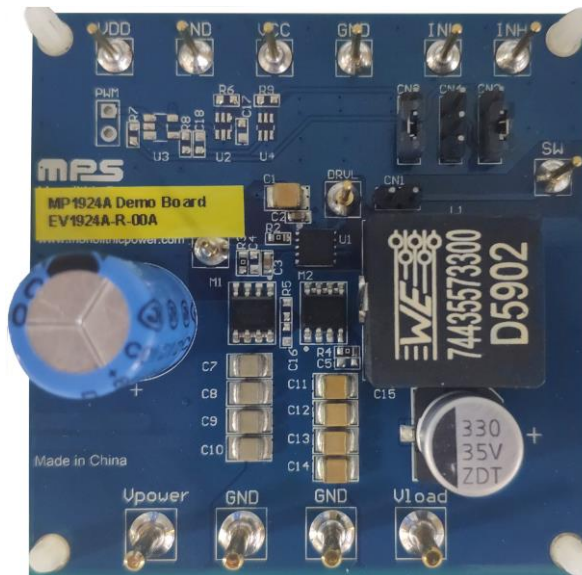

(LxWxH) 6.35cmx6.35cmx1cm

Board Number	MPS IC Number
EV1924A-R-00A	MP1924AHR

QUICK START GUIDE

1. Preset the driver power supply voltage V_{DD} between 8V and 15V.
2. Preset the input power supply voltage V_{POWER} between 0V and 100V.
3. Attach a complementary PWM with a proper dead time to CN4.
4. Attach the driver power supply to:
 - a. Positive (+): VDD
 - b. Negative (-): GND
5. Attach the input power supply to:
 - a. Positive (+): V_{POWER}
 - b. Negative (-): GND
6. Attach the load to:
 - a. Positive (+): V_{LOAD}
 - b. Negative (-): GND

7. Turn the driver power supply on.

Check the INH, INL, DRVH, and DRVL signals. Ensure that a sufficient dead time for DRVH and DRVL has been established before continuing to step 8.

8. Turn the input power supply on.
9. Turn the load on, then check output voltage and current.
10. To turn the system off, follow the steps below:
 - a. Turn the load off.
 - b. Turn V_{POWER} off.
 - c. Turn V_{DD} off.

EVALUATION BOARD SCHEMATIC

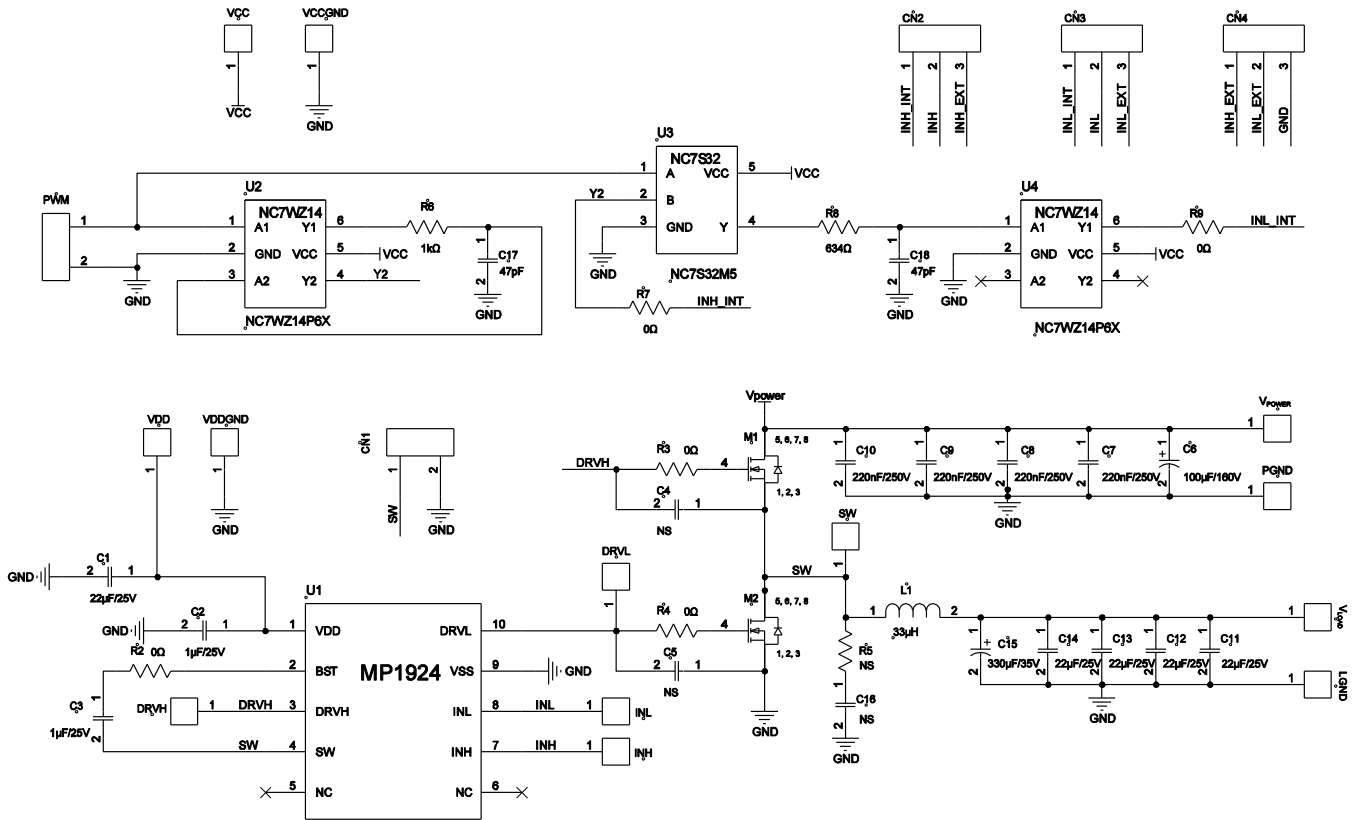

Figure 1: Evaluation Board Schematic

EV1924A-R-00A BILL OF MATERIALS

Qty	Ref	Value	Description	Package	Manufacturer	Manufacturer P/N
5	C1, C11, C12, C13, C14	22 μ F/ 25V	Ceramic capacitor, 25V, X5R	1210	Murata	GRM32ER71E226KE15L
2	C2, C3	1 μ F/ 25V	Ceramic capacitor, 25V, X5R	0603	TDK	C1608X5R1E105K
3	C4, C5, C16	NS				
1	C6	100 μ F/ 160V	Electrolytic capacitor, 160V	DIP	Jianghai	CD110-160V100
4	C7, C8, C9, C10	220nF/ 250V	Ceramic capacitor, 250V, X7R	1210	Murata	GRM32DR72E224KW01L
1	C15	330 μ F/ 35V	Electrolytic capacitor, 35V	SMD	Jianghai	VZ1-35V330
1	L1	33 μ H	Inductor, 33 μ H, 8.5A	SMD	Würth	74435573300
1	R5	NS				
3	R2, R3, R4	0 Ω	Film resistor, 5%	0603	Yageo	RC0603JR-070RL
2	M1, M2	AM4490N	N-channel MOSFET	PowerPAK SO-8	Analog Power	AM4490N
1	U1	MP1924A	Integrated gate driver	QFN-10 (4mmx4mm)	MPS	MP1924AHR
4	V ^{POWER} , V ^{LOAD} , GNDx2		2mm needle			
9	VDD, GND, VCC, GND, INL, INH, DRVH, DRVL, SW		1mm needle			

PCB LAYOUT

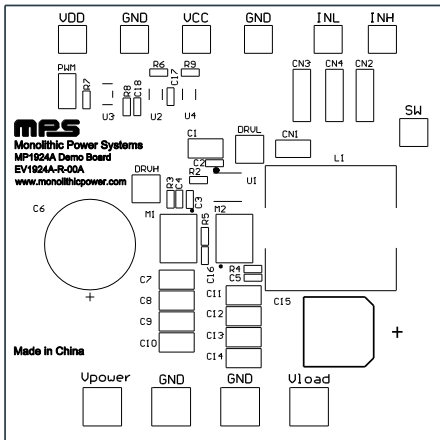

Figure 2: Top Silkscreen Layer

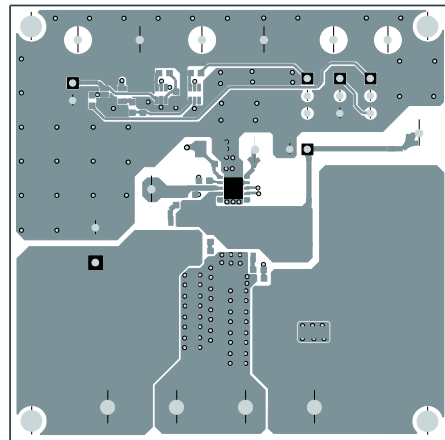

Figure 3: Top Layer

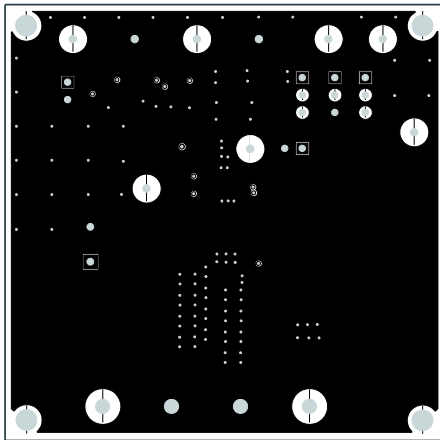

Figure 4: Mid-Layer 1

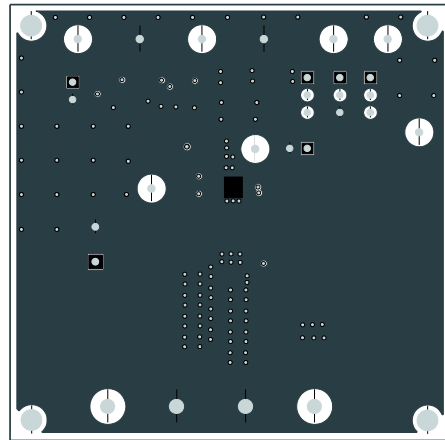

Figure 5: Mid-Layer 2

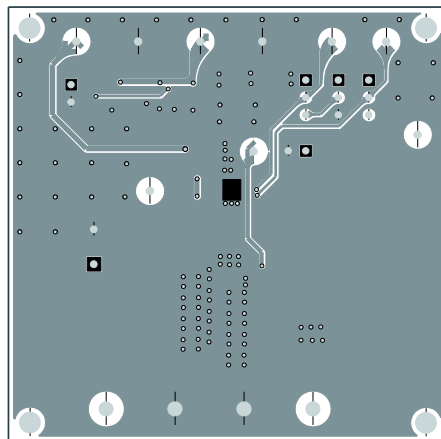

Figure 6: Bottom Layer



Revision History

Revision #	Revision Date	Description	Pages Updated
1.0	7/22/2020	Initial Release	-

Notice: The information in this document is subject to change without notice. Please contact MPS for current specifications. Users should warrant and guarantee that third-party Intellectual Property rights are not infringed upon when integrating MPS products into any application. MPS will not assume any legal responsibility for any said applications.