

DESCRIPTION

The EV175-S-00A Evaluation Board is designed to demonstrate the performance of MP175. The MP175 is a high performance and cost effective primary-side constant voltage regulator, which is ideal for home appliances, standby power and etc.

The EV175-S-00A is configured as a buck topology. It delivers 18V/550mA output.

The EV175-S-00A has an excellent efficiency and meets 1kV IEC61000-4-5 surge immunity and EN55022 conducted EMI requirements. It has multi-protection function: such as open circuit protection, over load protection, short-circuit protection and over-temperature protection, etc.

ELECTRICAL SPECIFICATION

Parameter	Symbol	Value	Units
Input Voltage	V_{IN}	85 to 265	VAC
Output Voltage	V_{OUT}	18	V
Output Current	I_{OUT}	0.55	A
Output Power	P_{OUT}	9.9	W

FEATURES

- Primary-Side non-isolated Constant Voltage Control (CV)
- Integrated 700V MOSFET with Minimal External Components
- Peak-Current Control with Peak Current Compression
- Limited Maximum Frequency and Frequency Foldback
- Multiple Protections: SCP, OLP, OTP, open loop and VCC UVLO
- Low Cost and Simple External circuit

APPLICATIONS

- Home appliances, white goods and consumer electronics
- Industrial controls
- Standby power

All MPS parts are lead-free, halogen-free, and adhere to the RoHS directive. For MPS green status, please visit MPS website under Quality Assurance. "MPS" and "The Future of Analog IC Technology", are Registered Trademarks of Monolithic Power Systems, Inc.



Warning: Although this board is designed to satisfy safety requirements, the engineering prototype has not been agency approved. Therefore, all testing should be performed using an isolation transformer to provide the AC input to the prototype board.

EV175-S-00A EVALUATION BOARD



TOP VIEW



BOTTOM VIEW

(L x W x H) 60mm x 35mm x 22mm	
Board Number	MPS IC Number
EV175-S-00A	MP175GS

EVALUATION BOARD SCHEMATIC

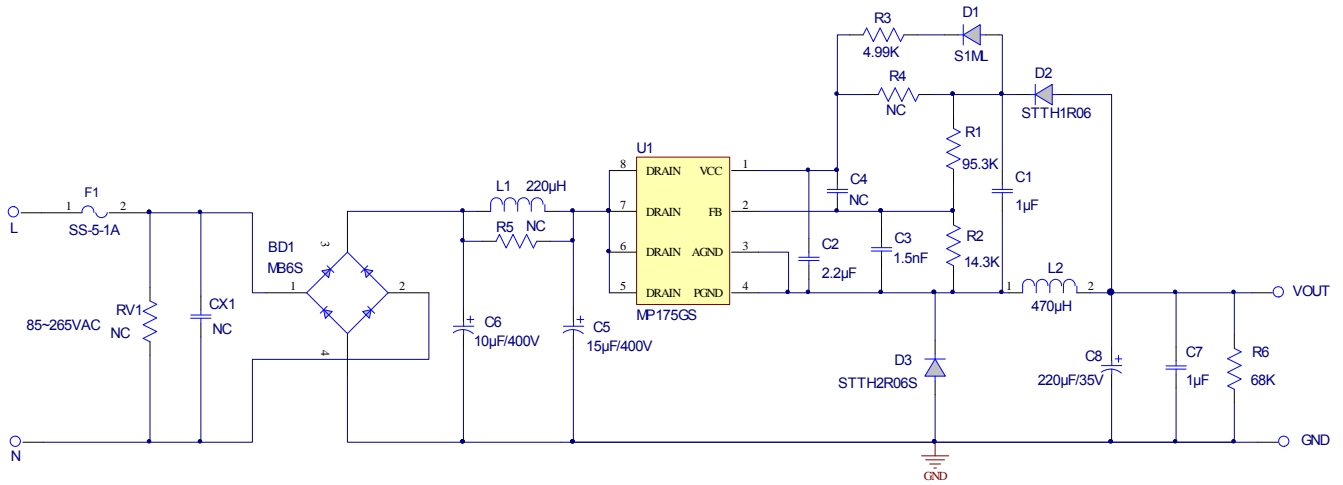

Figure 1—Schematic

PCB LAYOUT (SINGLE-SIDED)

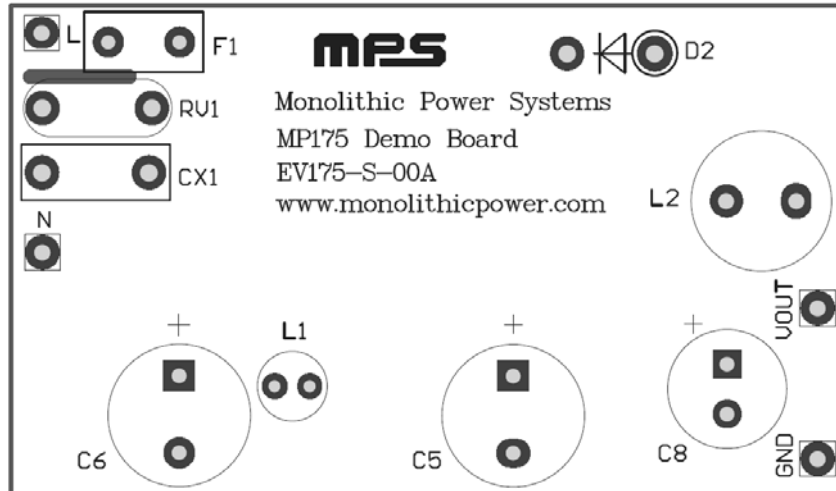

Figure 2—Top Layer

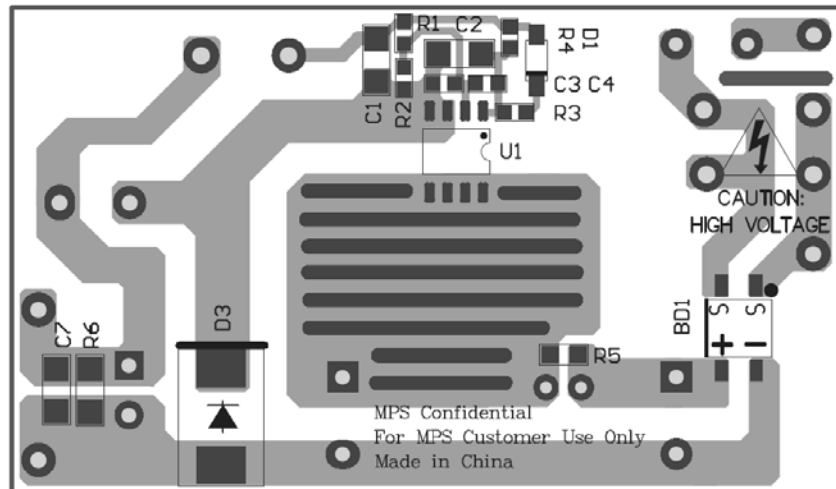

Figure 3—Bottom Layer

CIRCUIT DESCRIPTION

The EV175-S-00A is configured into a buck topology circuit. It uses the MP175 as the switching regulator, which can mostly simplify the schematic and get a cost effective BOM.

F1 is used to protect circuit from component failure or some excessive short events.

C6, L1 and C5 compose π filter to guarantee the conducted EMI meet standard EN55022. C6 and C5 also act as the input capacitor.

C2 is the VCC capacitor. R3 and D1 are used as auxiliary power supply circuit for VCC. Though MP175 is equipped with an internal high voltage current source, using this circuit can achieve better no load consumption and efficiency.

C1 is the sample-hold capacitor, used for sampling and holding the output voltage. R1 and R2 are resistor divider for feedback detection.

D2 is the diode for feedback. It blocks the high voltage when internal MOSFET of MP175 is turned on.

L2 is power inductor. It should be chosen with appropriate current rating. It should be placed far away from the input filter and a.c. input circuit in order to get better EMI performance.

D3 is freewheeling diode for 18V output. Select a diode with a maximum reverse block voltage rating that exceeds the maximum input voltage. For universal voltage applications, use a diode with a 600V reverse block voltage. Ultra-fast recovery diode is recommended for better efficiency.

C8 and C7 are output capacitors for 18V output. C8 should be low ESR electrolytic capacitor if smaller output ripple is required. C7 is ceramic capacitor to reduce high frequency voltage ripple. R6 is dummy load to regulate the output voltage of 18V rail at no load condition.

EV175-S-00A BILL OF MATERIALS

Qty	Ref	Value	Description	Package	Manufacture	Manufacture_PN
1	BD1	MB6S	Bridge Diode;600V;0.5A	SOIC4	Taiwan Semiconductor	MB6S
1	C1	1 μ F	Ceramic Capacitor;50V;X7R	1206	TDK	C3216X7R1H105K
1	C2	2.2 μ F	Ceramic Capacitor;50V;X7R	1206	muRata	GRM31CR71H225KA88L
1	C3	1.5nF	Ceramic Capacitor;50V;X7R	0603	muRata	GRM216R71H152KA01D
0	C4	NC				
1	C5	15 μ F	Electrolytic Capacitor;400V;20%	DIP	CHENGXING	400V 15uF 10*17
1	C6	10 μ F	Electrolytic Capacitor;400V;20%	DIP	CHENGXING	400V 10uF 10*13
1	C7	1 μ F	Ceramic Capacitor;50V;X7R	1206	muRata	GRM31MR71H105KA88L
1	C8	220 μ F	Electrolytic Capacitor;35V	DIP	永铭	LK_35V_220uF_8*11.5
1	D1	S1ML	Diode;1000V;1A	SOD123	Taiwan Semiconductor	S1ML
1	D2	STTH1R06	Diode;600V;1A	DO-41	ST	STTH1R06
1	D3	STTH2R06S	Diode;600V;2A	SMC	ST	STTH2R06S
1	F1	SS-5-1A	Fuse;250V;1A	DIP	COOPER BUSSMAN	SS-5-1A
1	L1	220 μ H	Inductor;220 μ H;0.96Ohm;0.5A	DIP	Wurth	7447462221
1	L2	470 μ H	Inductor;470 μ H;0.47Ohm;1.15A	DIP	Wurth	7447480471
1	R1	95.3k	Film Resistor;1%	0603	Yageo	RC0603FR-0795K3L
1	R2	14.3k	Film Resistor;1%	0603	Yageo	RC0603FR-0714K3L
1	R3	4.99k	Film Resistor;1%	0603	Yageo	RC0603FR-074K99L
0	R4	NC				
0	R5	NC				
1	R6	68k	Film Resistor;5%	1206	Any	1206J0683T5E
1	U1	MP175	Primary side regulator	SOIC8	MPS	MP175GS

EVB TEST RESULTS

$V_{IN} = 85\text{--}265\text{VAC}$, $V_{OUT} = 18\text{V}$, $I_{OUT} = 550\text{mA}$, $T_A = 25^\circ\text{C}$, unless otherwise noted.

No Load Consumption

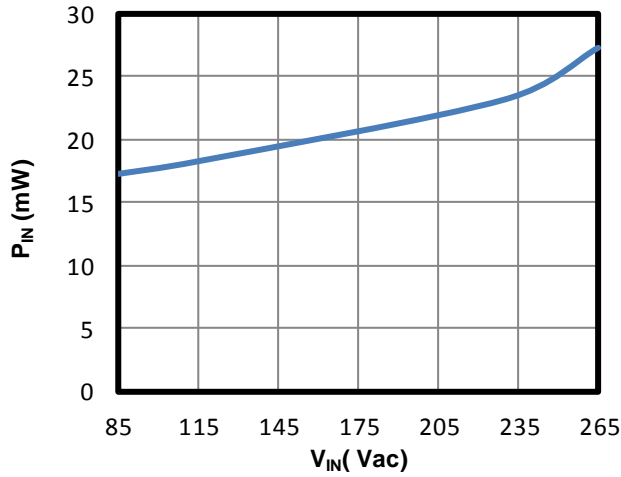

Efficiency

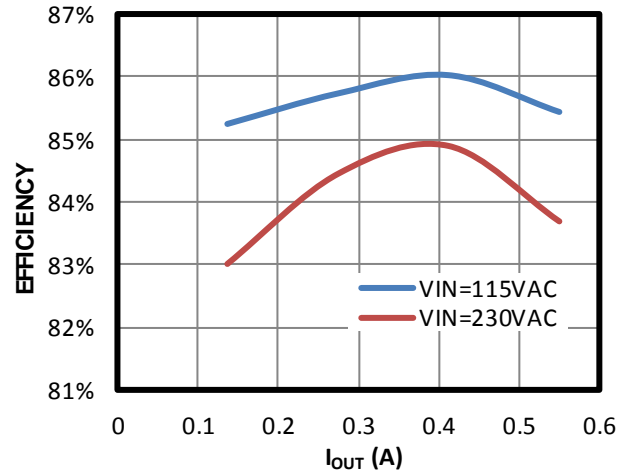

EVB TEST RESULTS

$V_{IN} = 230VAC$, $V_{OUT} = 18V$, $I_{OUT} = 550mA$, $T_A = 25^{\circ}C$, unless otherwise noted.

Power On

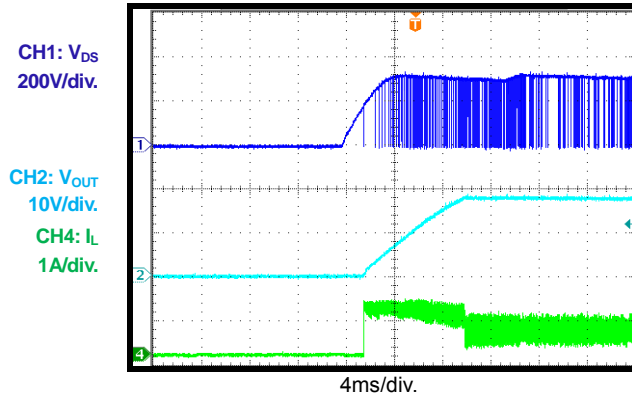

Power Off

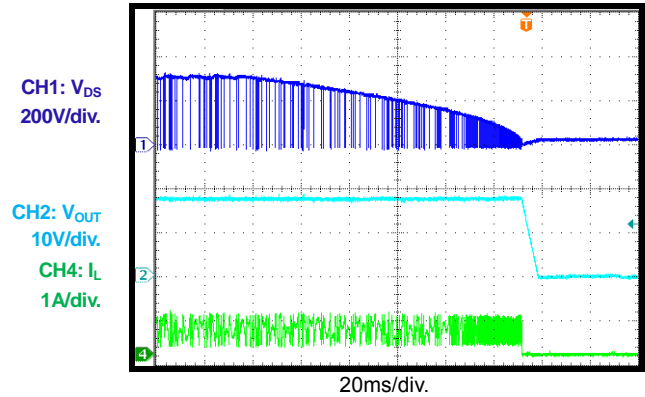

OLP Entry

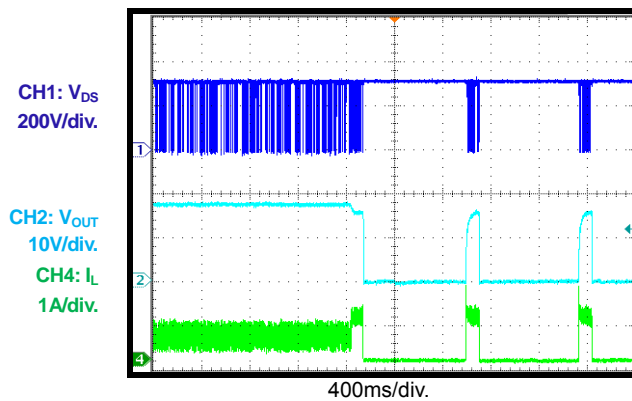

OLP Recovery

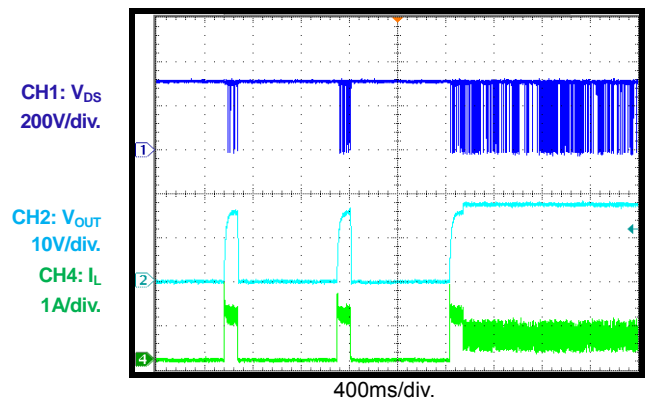

OLP Power On

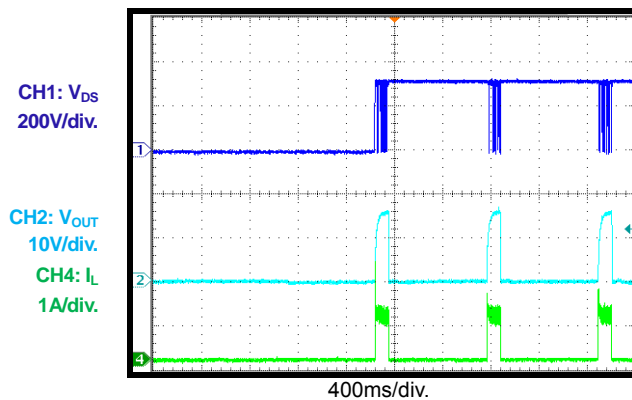

SCP Entry

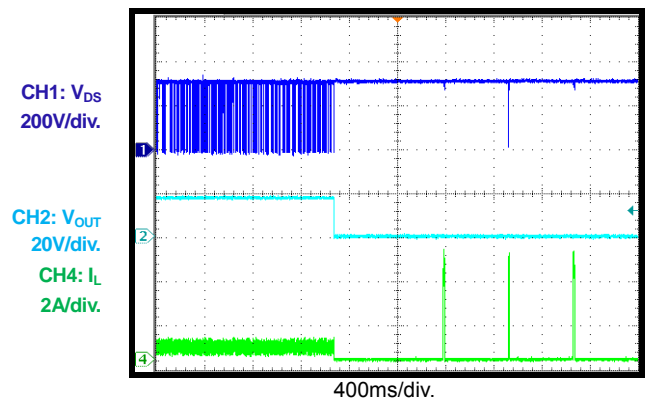

EVB TEST RESULTS

$V_{IN} = 230VAC$, $V_{OUT} = 18V$, $I_{OUT} = 550mA$, $T_A = 25^{\circ}C$, unless otherwise noted.

SCP Recovery

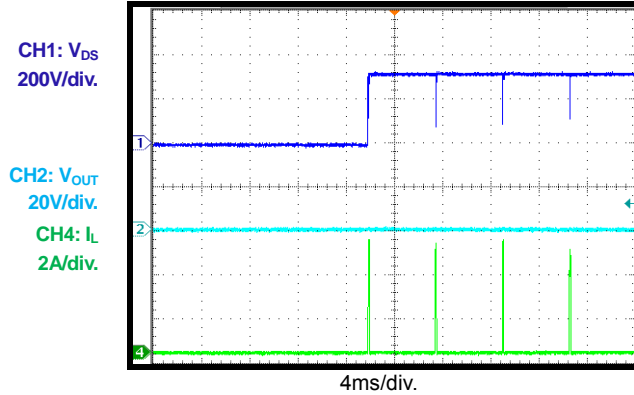

SCP Power On

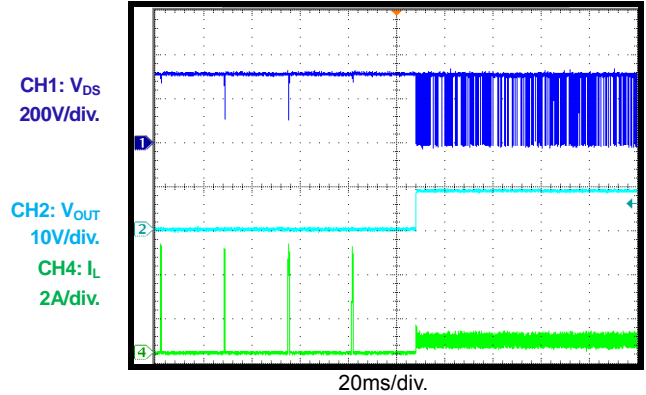

Open Loop Power On

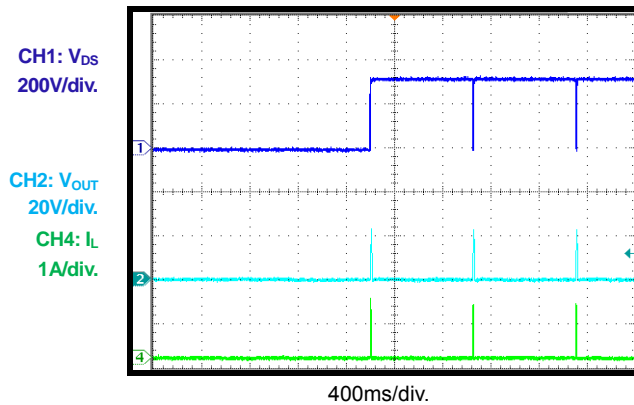

Conducted EMI
Live Wire

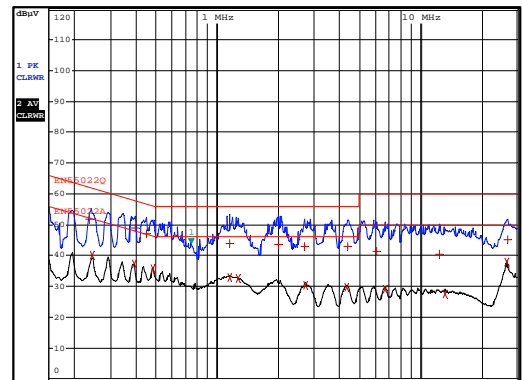

Conducted EMI
Neutral Wire

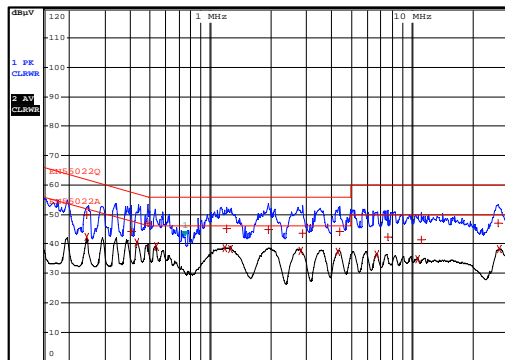

QUICK START GUIDE

1. Preset Power Supply to $85\text{VAC} \leq V_{\text{IN}} \leq 265\text{VAC}$.
2. Turn Power Supply off.
3. Connect the Line and Neutral terminals of the power supply output to L and N port.
4. Connect Different Load to Corresponding Outputs :
 - a. Positive (+): VOUT
 - b. Negative (-): GND
5. Turn Power Supply on after making connections.

NOTICE: The information in this document is subject to change without notice. Please contact MPS for current specifications. Users should warrant and guarantee that third party Intellectual Property rights are not infringed upon when integrating MPS products into any application. MPS will not assume any legal responsibility for any said applications.