



The Future of Analog IC Technology™

EV1518DG-00A

Fixed Frequency WLED Driver Evaluation Board

GENERAL DESCRIPTION

The EV1518DG-00A is an evaluation board for the MP1518, a step-up converter designed for driving up to 6 series white LEDs from a single cell Lithium Ion battery. The MP1518 uses current mode, fixed frequency architecture to regulate the LED current, which is measured through an external current sense resistor. Its low 104mV feedback voltage reduces power loss and improves efficiency. The OV pin monitors the output voltage and turns off the converter if an over-voltage condition is present due to an open circuit condition.

The MP1518 includes under-voltage lockout, current limiting and thermal overload protection preventing damage in the event of an output overload.

ELECTRICAL SPECIFICATIONS

Parameter	Symbol	Value	Units
Input Voltage	V_{IN}	2.5 – 6.0	V
# of WLEDs		Up to 6	
LED Current	I_{LED}	20	mA

FEATURES

- On Board Power MOSFET
- Drives up to 6 Series White LEDs
- Up to 87% Efficiency
- Over 1MHz Fixed Switching Frequency
- Open Load Shutdown
- Low 104mV Feedback Voltage
- Soft Start/PWM Dimming
- UVLO, Thermal Shutdown
- Internal Current Limit

APPLICATIONS

- Cell Phones
- Handheld Computers and PDAs
- Digital Still Cameras
- Small LCD Displays

"MPS" and "The Future of Analog IC Technology" are Trademarks of Monolithic Power Systems, Inc.

EV1518DG-00A EVALUATION BOARD

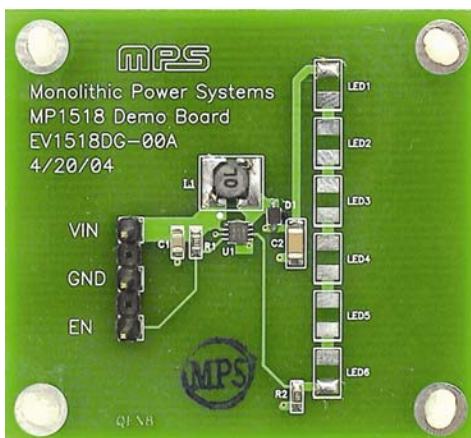

(L x W x H) 2.0" x 1.8" x 0.4"
(5.0cm x 4.5cm x 1.0cm)

Board Number	MPS IC Number
EV1518DG-00A	MP1518DG

Efficiency vs LED Current

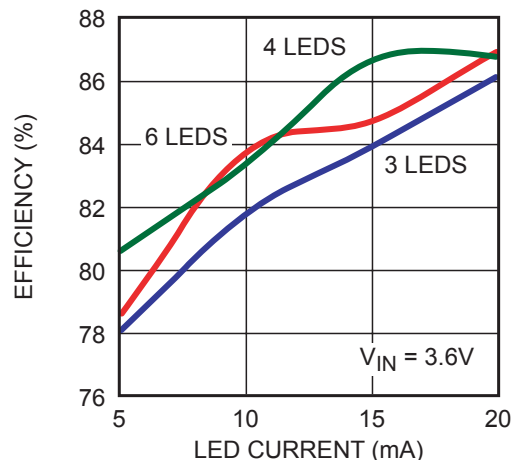

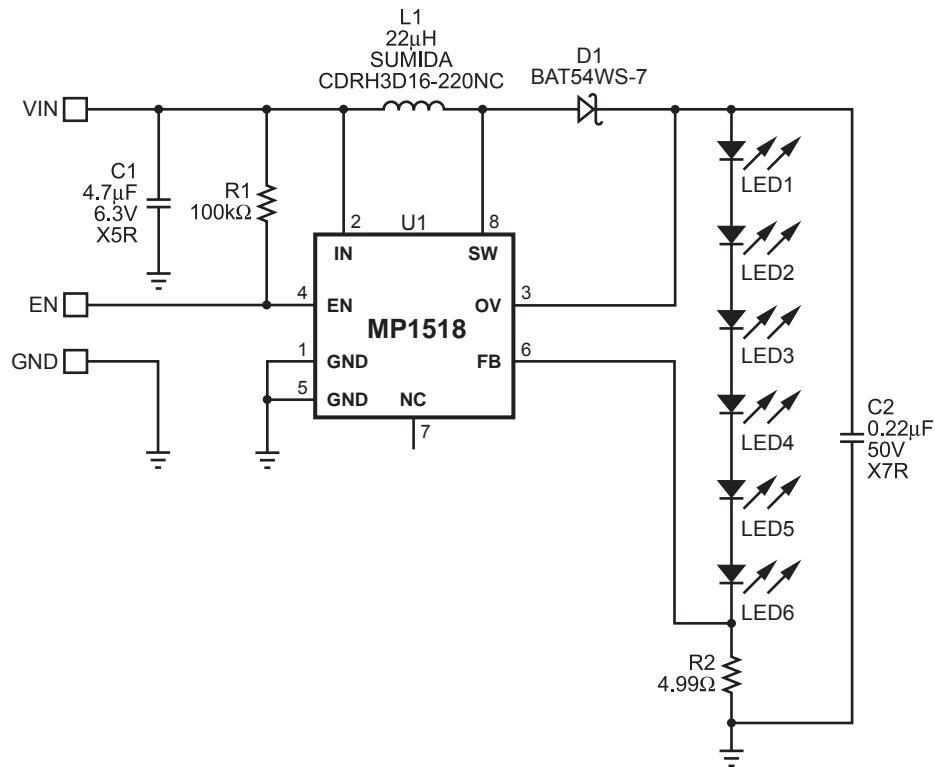
EVALUATION BOARD SCHEMATIC

EV1518DG-00A BILL OF MATERIALS

Qty	Ref	Value	Description	Package	Manufacturer	Manufacturer P/N
1	C1	4.7µF	Ceramic Capacitor, 6.3V, X5R	0805	TDK	C2012X5R0J475M
1	C2	0.22µF	Ceramic Capacitor, 50V, X7R	1206	TDK	C3216X7R1H224K
1	D1		Diode Schottky, 30V, 200mW	SOD-323	Diodes Inc	BAT54WS-7
1	L1	22µH	400mA	SMD	Sumida	CDRH3D16-220NC
6	LED1, LED2, LED3, LED4, LED5, LED6		Not Stuffed			
1	R1	100kΩ	Resistor, 5%	0805	Panasonic	ERJ-6GEYJ104V
1	R2	4.99Ω	Resistor, 1%	0805	Yageo	9C08052A4R99FKHFT
1	U1		White Led Driver	QFN8 (2x2)	MPS	MP1518DG

PRINTED CIRCUIT BOARD LAYOUT

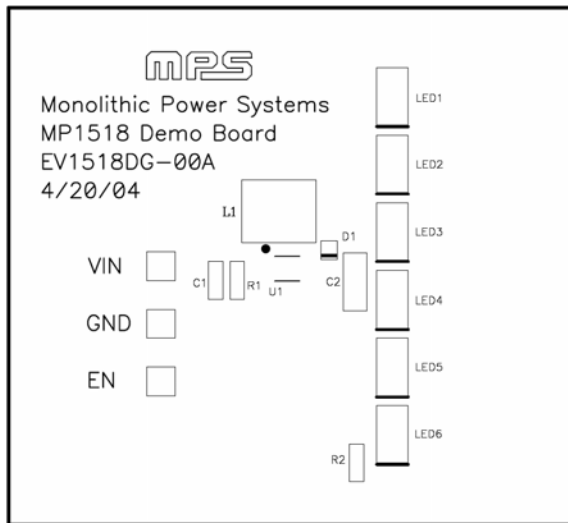

Figure 1—Top Silk Layer

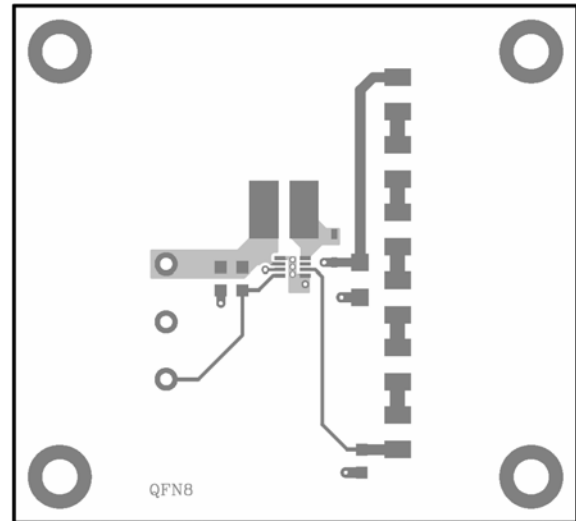

Figure 2—Top Layer

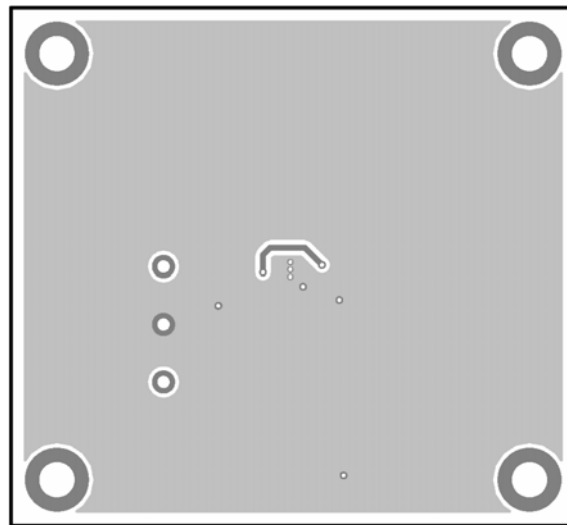

Figure 3—Bottom Layer

QUICK START GUIDE

1. Solder LED1 – LED6 to board.
2. Connect the positive and negative terminals of the power supply (2.5V to 6V) to the VIN and GND pins, respectively.
3. This board is set up for automatic startup. Pull EN low to shut down the MP1518.
4. To use burst mode brightness control, drive EN with a PWM signal.

NOTICE: The information in this document is subject to change without notice. Users should warrant and guarantee that third party Intellectual Property rights are not infringed upon when integrating MPS products into any application. MPS will not assume any legal responsibility for any said applications.