

DESCRIPTION

The MA330 detects the absolute angular position of a permanent magnet, typically a diametrically magnetized cylinder on a rotating shaft. Fast data acquisition and processing provide accurate angle measurement at speeds from 0rpm to 60,000rpm. The digital filtering is adjustable to optimize control loop performance when used in servo applications.

The MA330 supports a wide range of magnetic field strengths and spatial configurations. Both end-of-shaft and off-axis (side-shaft mounting) configurations are supported.

The MA330 features magnetic field strength detection with programmable thresholds to allow sensing of the magnet position relative to the sensor for creation of functions such as sensing axial movements or for diagnostics.

On-chip, non-volatile memory provides storage for configuration parameters, including the reference zero angle position, ABZ encoder settings, UVW pole pair emulation settings, and magnetic field detection thresholds.

FEATURES

- 9-Bit to 14-Bit Resolution Absolute Angle Encoder
- Contactless Sensing for Long Life
- SPI Serial Interface for Digital Angle Readout and Chip Configuration
- Incremental 12-Bit ABZ Quadrature Encoder Interface with Programmable Pulses Per Turn from 1 to 1024
- UVW Interface with 1-Pole to 8-Pole Pair Emulation
- Programmable Magnetic Field Strength Detection for Diagnostic Checks
- 3.3V, 12mA Supply
- -40°C to +125°C Operating Temperature
- Available in a QFN-16 (3mmx3mm) Package

APPLICATIONS

- Brushless DC Motor Servo Drives
- Motor Commutation
- Motor Speed and Position Control
- Robotics

All MPS parts are lead-free, halogen-free, and adhere to the RoHS directive. For MPS green status, please visit the MPS website under Quality Assurance. "MPS", the MPS logo, and "Simple, Easy Solutions" are registered trademarks of Monolithic Power Systems, Inc. or its subsidiaries.

TYPICAL APPLICATION

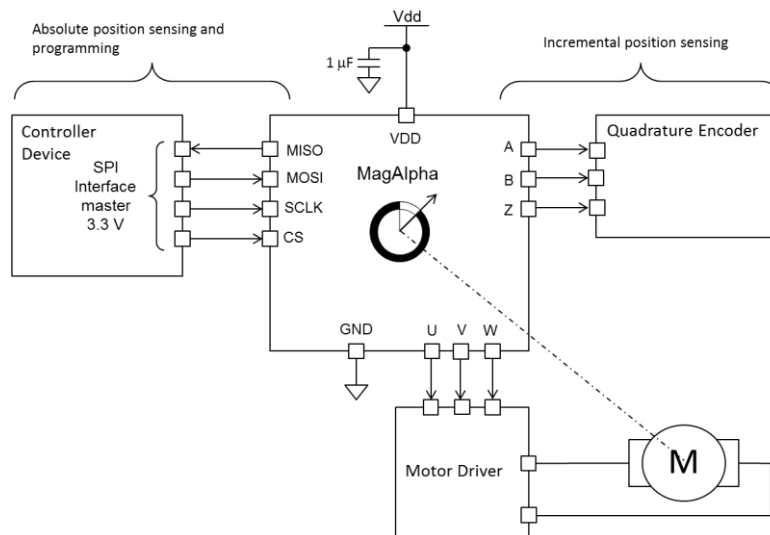

ORDERING INFORMATION

Part Number*	Package	Top Marking
MA330GQ	QFN-16 (3mmx3mm)	See Below

* For Tape & Reel, add suffix -Z (e.g. MA330GQ-Z).

TOP MARKING

—
BKAY
LLL

BKA: Product code of MA330GQ
 Y: Year code
 LLL: Lot number

PACKAGE REFERENCE

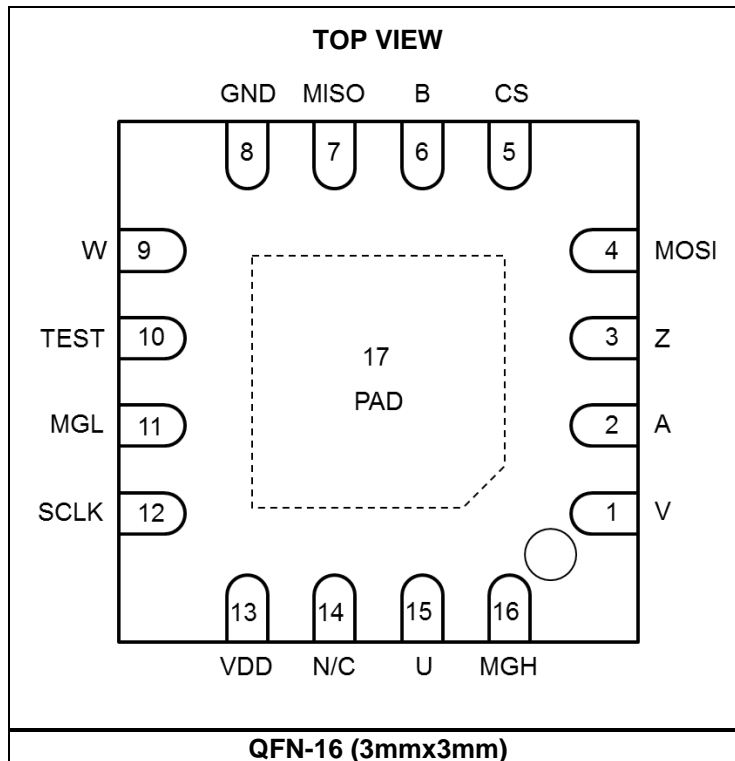

PIN FUNCTIONS

Pin #	Name	Description
1	V	Motor commutation output.
2	A	Incremental output.
3	Z	Incremental output.
4	MOSI	Data in (SPI). MOSI has an internal pull-down resistor.
5	CS	Chip select (SPI). CS has an internal pull-up resistor.
6	B	Incremental output.
7	MISO	Data out (SPI). MISO has an internal pull-down resistor that is enabled at a high-impedance state.
8	GND	Supply ground.
9	W	Motor commutation output.
10	TEST	Connect to ground.
11	MGL	Digital output indicating field strength below MGLT level.
12	SCLK	Clock (SPI). SCLK has an internal pull-down resistor.
13	VDD	Supply 3.3V.
14	NC	No connection. Leave NC unconnected.
15	U	Motor commutation output.
16	MGH	Digital output indicating field strength above MGHT level.

ABSOLUTE MAXIMUM RATINGS ⁽¹⁾

Supply voltage	-0.5V to +4.6V
Input pin voltage (V _I)	-0.5V to +6.0V
Output pin voltage (V _O)	-0.5V to +4.6V
Continuous power dissipation (T _A = 25°C) ⁽²⁾	2.0W
Junction temperature	125°C
Lead temperature	260°C
Storage temperature	-65°C to +150°C

Thermal Resistance ⁽³⁾	θ_{JA}	θ_{JC}
QFN-16 (3mmx3mm)	50	12 ... °C/W

Notes:

- 1) Exceeding these ratings may damage the device.
- 2) The maximum allowable power dissipation is a function of the maximum junction temperature T_J (MAX), the junction-to-ambient thermal resistance θ_{JA}, and the ambient temperature T_A. The maximum allowable continuous power dissipation at any ambient temperature is calculated by P_D (MAX) = (T_J (MAX) - T_A) / θ_{JA}.
- 3) Measured on JESD51-7, 4-layer PCB.

ELECTRICAL CHARACTERISTICS

Parameter	Symbol	Condition	Min	Typ	Max	Units
Recommended Operating Conditions						
Supply voltage	V _{DD}		3.0	3.3	3.6	V
Supply current	I _{DD}	From -40°C to +125°C	10.2	11.7	13.8	mA
Operating temperature	T _{OP}		-40		+125	°C
Applied magnetic field	B		30	60		mT

GENERAL CHARACTERISTICS

VDD = 3.3V, 45mT < B < 100mT, temp = -40°C to +125°C, unless otherwise noted.

Parameter	Symbol	Condition	Min	Typ	Max	Units
Absolute Output – Serial						
Effective resolution ($\pm 3\sigma$)		Filter window t = 64 μ s	9.0	9.8	10.5	bits
		Filter window t = 16ms	13.0	13.8	14.5	bits
Noise RMS		Filter window t = 64 μ s	0.04	0.07	0.12	Deg
		Filter window t = 16ms	0.003	0.004	0.007	deg
Refresh rate			850	980	1100	kHz
Data output length			14		14	bits
Response Time						
Power-up time ⁽⁴⁾		Filter window t = 64 μ s			0.6	ms
		Filter window t = 16ms			260	ms
Latency ⁽⁵⁾		Constant speed propagation delay	8		10	μ s
Filter cutoff frequency ⁽⁴⁾	f _{CUTOFF}	Filter window t = 64 μ s		6		kHz
	f _{CUTOFF}	Filter window t = 16ms		23		Hz
Accuracy						
INL at 25°C		At room temperature over the full field range		0.7		deg
INL between -40°C to +125°C ⁽⁵⁾		Over the full temperature range and field range		1.1		deg
Output Drift						
Temperature induced drift at room temperature ⁽⁵⁾				0.015		deg/°C
Temperature induced variation ⁽⁵⁾		From 25°C to 85°C		0.5		deg
		From 25°C to 125°C		1.0		deg
Magnetic field induced ⁽⁵⁾				0.005		deg/mT
Voltage supply induced ⁽⁵⁾					0.3	deg/V
Incremental Output – ABZ						
ABZ update rate				16		MHz
Resolution – edges per turn		Programmable	4		4096	
Pulses per channel per turn	PPT+1	Programmable	1		1024	
ABZ hysteresis ⁽⁵⁾	H	Programmable	0.08		2.8	deg
Systematic jitter ⁽⁵⁾		For PPT = 1023, up to 60mT			11	%
		For PPT = 127			7	%
Incremental Output – UVW						
Cycle per turn	NPP		1		8	
UVW hysteresis ⁽⁵⁾	H				0.7	deg
UVW jitter (3 σ) ⁽⁵⁾				0.1	0.3	deg

GENERAL CHARACTERISTICS (continued)
VDD = 3.3V, 45mT < B < 100mT, temp = -40°C to +125°C, unless otherwise noted.

Parameter	Symbol	Condition	Min	Typ	Max	Units
Magnetic Field Detection Thresholds						
Accuracy ⁽⁵⁾				5		mT
Hysteresis ⁽⁵⁾	MagHys			6		mT
Temperature drift ⁽⁵⁾				-600		ppm/°C
Digital I/O						
Input high voltage	V _{IH}		2.5		5.5	V
Input low voltage	V _{IL}		-0.3		+0.8	V
Output low voltage ⁽⁵⁾	V _{OL}	I _{OL} = 4mA			0.4	V
Output high voltage ⁽⁵⁾	V _{OH}	I _{OH} = 4mA	2.4			V
Pull-up resistor	R _{PU}		46	66	97	kΩ
Pull-down resistor	R _{PD}		43	55	97	kΩ
Rising edge slew rate ⁽⁴⁾	t _R	CL = 50pF		0.7		V/ns
Falling edge slew rate ⁽⁴⁾	t _F	CL = 50pF		0.7		V/ns

Notes:

- 4) Guaranteed by design.
- 5) Guaranteed by characteristic test.

TYPICAL CHARACTERISTICS

VDD = 3.3V, temp = 25°C, unless otherwise noted.

**ABZ Jitter at PPT = 255,
tau = 1ms**

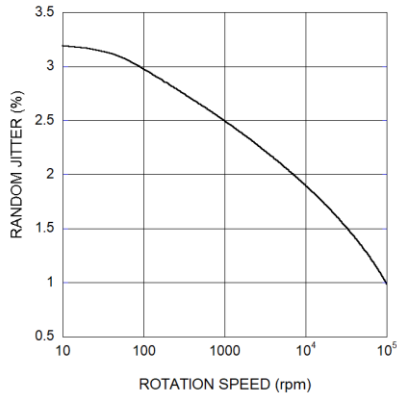

**Noise Spectrum at 50mT,
t = 16ms**

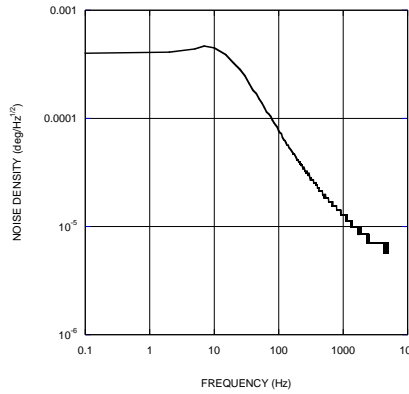

**Filter Transfer Function at
t = 16ms**

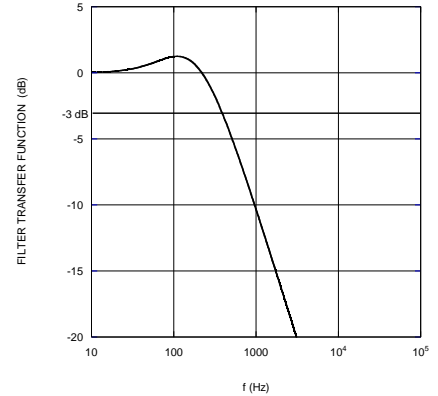

Error Curves at 50mT

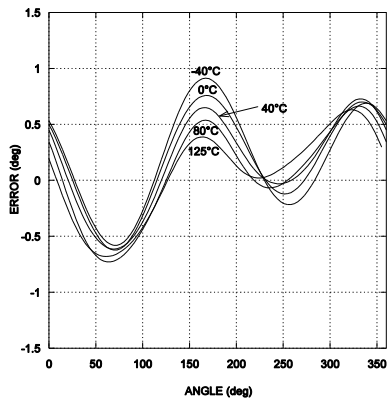

**Nonlinearity
(INL and Harmonics)**

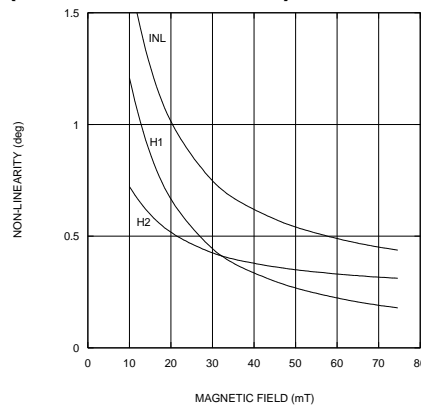

Effective Resolution (3σ)

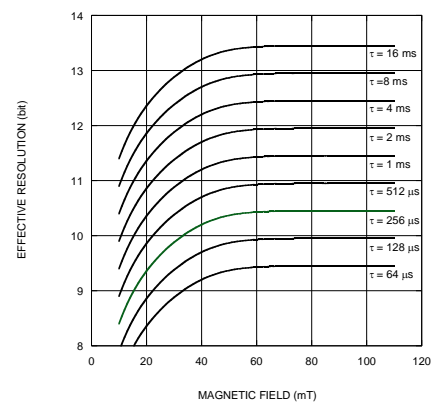

**Current Consumption at
VDD = 3.3V**

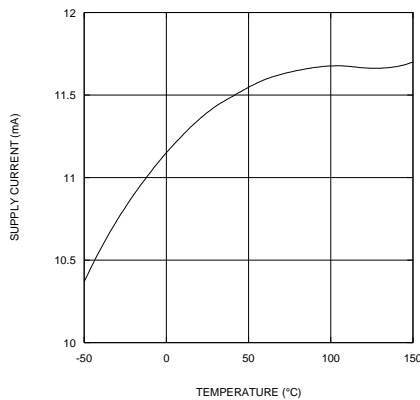

FUNCTIONAL BLOCK DIAGRAM

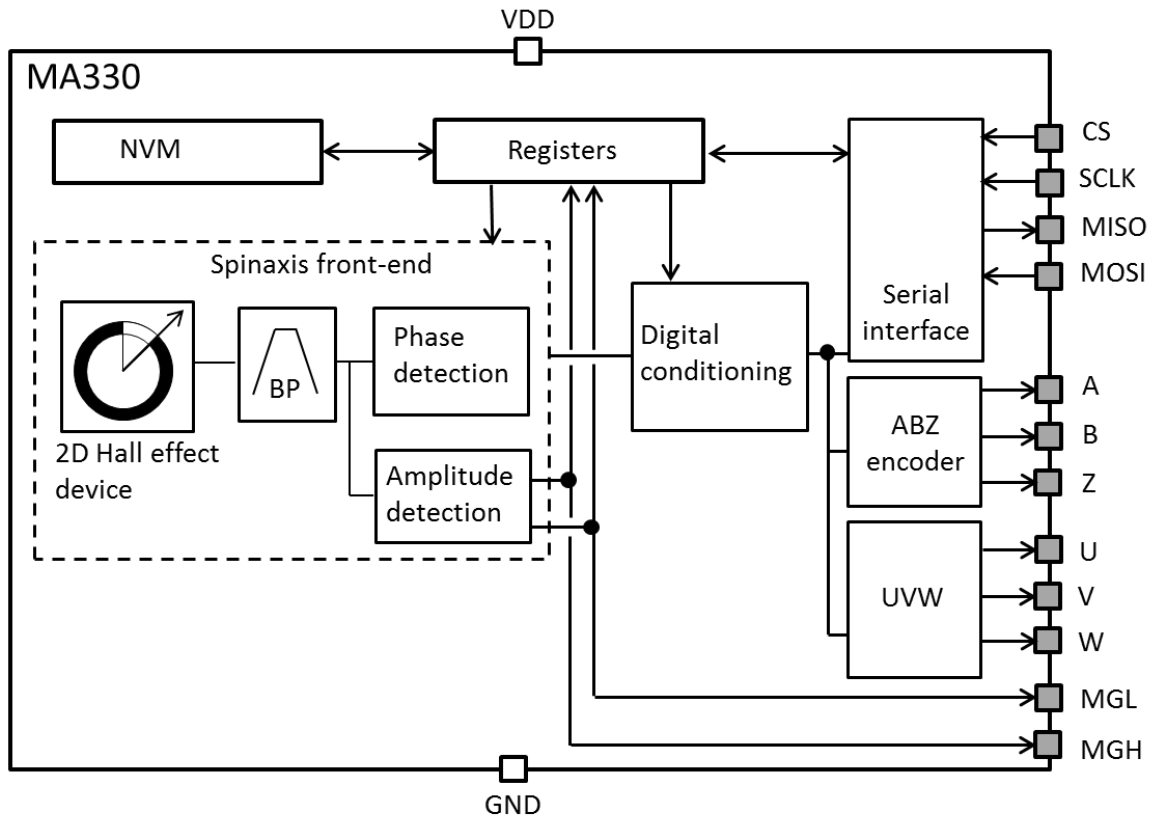

Figure 1: Functional Block Diagram

OPERATION

Sensor Front-End

The magnetic field is detected with integrated Hall devices located in the center of the package. The angle is measured using the Spinaxis™ method, which directly digitizes the direction of the field without complex arctangent computation or feedback loop-based circuits (interpolators).

The Spinaxis™ method is based on phase detection, and generates a sinusoidal signal with a phase that represents the angle of the magnetic field. The angle is then obtained by a time-to-digital converter, which measures the time between the zero crossing of the sinusoidal signal and the edge of a constant waveform (see Figure 2). The time-to-digital is outputted from the front-end to the digital conditioning block.

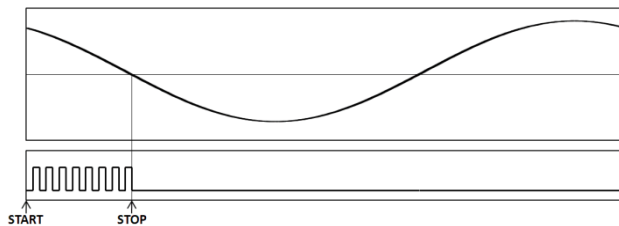

Top – Sine Waveform
Bottom – Clock of Time-to-Digital Converter
Figure 2: Phase Detection Method

The output of the front-end delivers a digital number proportional to the angle of the magnetic field at the rate of 1MHz in a straightforward and open-loop manner.

Digital Filtering

The front-end signal is further treated to achieve the final effective resolution. This treatment does not add any latency in steady conditions. The filter transfer function can be calculated with Equation (1):

$$H(s) = \frac{1 + 2\tau s}{(1 + \tau s)^2} \quad (1)$$

Where t is the filter time constant, related to the cutoff frequency by $t = 0.38 / f_{\text{CUTOFF}}$. See the General Characteristics table on page 5 for the values of f_{CUTOFF} .

Sensor – Magnet Mounting

The sensitive volume of the MA330 is confined in a region less than 100µm wide that has multiple integrated Hall devices. This volume is located both horizontally and vertically within 50µm of the center of the QFN package. The sensor detects the angle of the magnetic field projected in a plane parallel to the package's upper surface. This means that the only relevant magnetic field is the in-plane component (X and Y components) in the middle point of the package.

By default, when looking at the top of the package, the angle increases when the magnetic field rotates clockwise. Figure 3 shows the zero angle of the unprogrammed sensor, where the cross indicates the sensitive point. Both the rotation direction and the zero angle can be programmed.

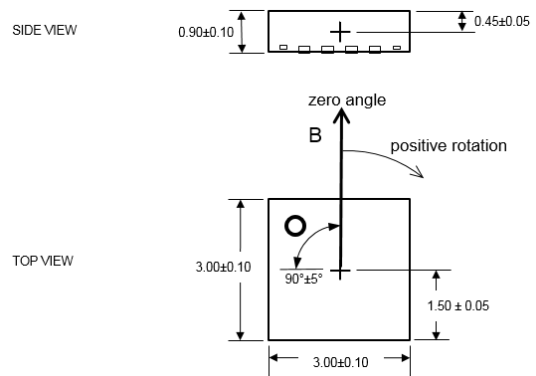

Figure 3: Detection Point and Default Positive Direction

This type of detection provides flexibility for the design of an angular encoder. The sensor only requires the magnetic vector to lie essentially within the sensor plane with a field amplitude of at least 30mT. Note that the MA330 can work with fields smaller than 30mT, but the linearity and resolution performance may deviate from the specifications. The most straightforward mounting method is to place the MA330 sensor on the rotation axis of a permanent magnet (e.g. a diametrically magnetized cylinder) (see Figure 4). A typical magnet is a Neodymium alloy (N35) cylinder with Ø5mmx3mm dimensions inserted into an aluminum shaft, keeping a 1.5mm air gap between the magnet and the sensor (surface of package). For good

linearity, the sensor is positioned with a precision of 0.5mm.

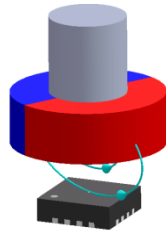

Figure 4: End-of-Shaft Mounting

If the end-of-shaft position is not available, the sensor can be positioned away from the rotation axis of a cylinder or ring magnet (see Figure 5). In this case, the magnetic field angle is no longer directly proportional to the mechanical angle. The MA330 can be adjusted to compensate for this effect and recover the linear relationship between the mechanical angle and the sensor output. With multiple pole pair magnets, the MA330 indicates multiple rotations for each mechanical turn.

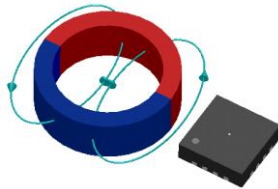

Figure 5: Side-Shaft Mounting

Electrical Mounting and Power Supply Decoupling

It is recommended to place a 1 μ F decoupling capacitor close to the sensor with a low-impedance path to GND (see Figure 6).

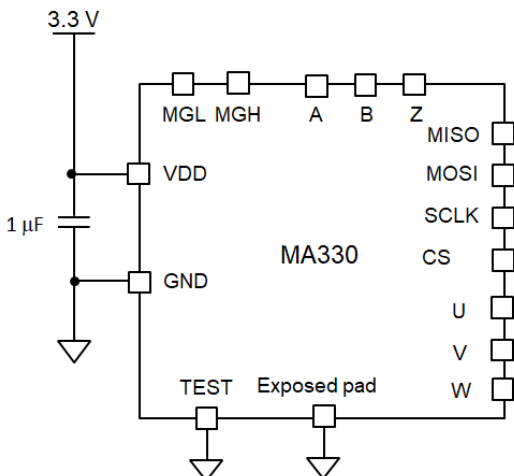

Figure 6: Connection for Supply Decoupling

Though the MagAlpha generally works fine with or without the exposed pad connected to anything, for optimum conditions (electrically, thermally, and mechanically), it is recommended to connect the exposed pad to ground.

Serial Interface

The sensor supports the SPI serial interface for angle reading and register programming.

SPI

SPI is a 4-wire, synchronous, serial communication interface. The MagAlpha supports SPI mode 3 and mode 0 (see Table 1 and Table 2). The SPI mode (0 or 3) is detected automatically by the sensor, and does not require any action from the user. The maximum clock rate supported on SPI is 25MHz. There is no minimum clock rate. Note that real life data rates depend on PCB layout quality and signal trace length. See Figure 7, Figure 8, and Table 3 for SPI timing.

All commands to the MagAlpha (whether for writing or reading register content) must be transferred through the SPI MOSI pin, and must be 16 bits long. See the SPI Communication section on page 13 for details.

Table 1: SPI Specification

	Mode 0	Mode 3
SCLK Idle State	Low	High
Data Capture	On SCLK rising edge	
Data Transmission	On SCLK falling edge	
CS Idle State	High	
Data Order	MSB first	

Table 2: SPI Standard

	Mode 0	Mode 3
CPOL	0	1
CPHA	0	1
Data Order (DORD)	0 (MSB first)	

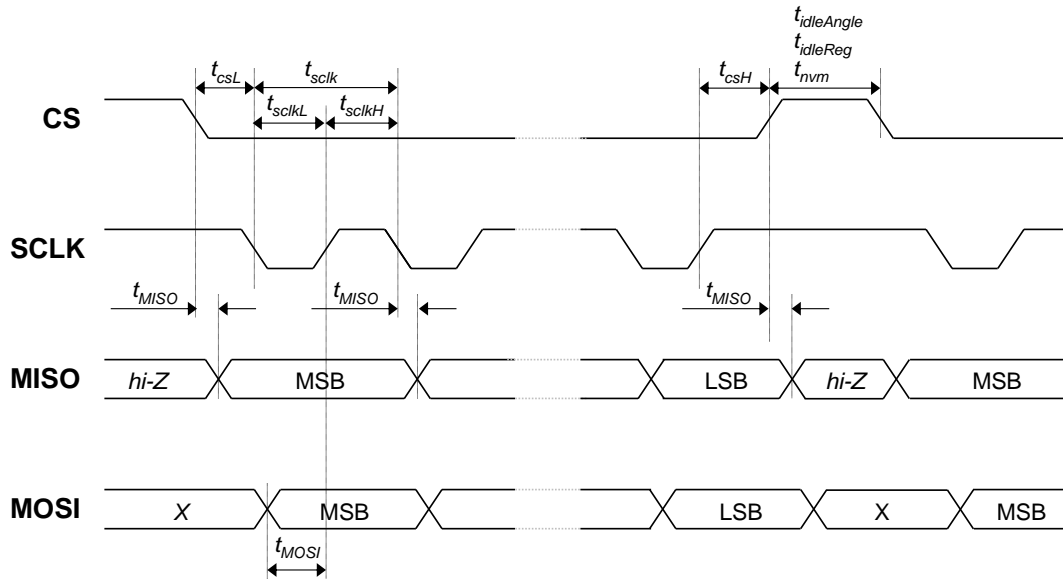

Figure 7: SPI Timing Diagram

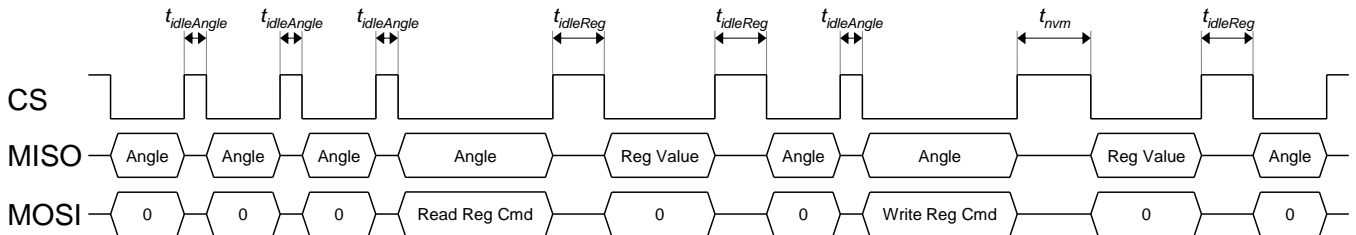

Figure 8: Minimum Idle Time

Table 3: SPI Timing

Parameter ⁽⁶⁾	Description	Min	Max	Unit
$t_{idleAngle}$	Idle time between two subsequent angle transmissions	150		ns
$t_{idleReg}$	Idle time before and after a register readout	750		ns
t_{nvm}	Idle time between a write command and a register readout (delay necessary for non-volatile memory update)	20		ms
t_{csL}	Time between CS falling edge and SCLK falling edge	80		ns
t_{sclk}	SCLK period	40		ns
t_{sclkL}	Low level of SCLK signal	20		ns
t_{sclkH}	High level of SCLK signal	20		ns
t_{csH}	Time between SCLK rising edge and CS rising edge	25		ns
t_{MISO}	SCLK setting edge to data output valid		15	ns
t_{MOSI}	Data input valid to SCLK reading edge	15		ns

Note:

6) All values are guaranteed by design.

PI Communication

The sensor supports three types of SPI operation:

- Read angle
- Read configuration register
- Write configuration register

Each operation has a specific frame structure, described below.

SPI Read Angle

Every 1µs, new data is transferred into the output buffer. The master device triggers the reading by pulling CS low.

When a trigger event is detected, the data remains in the output buffer until the CS signal is de-asserted (see Table 4).

Table 4: Sensor Data Timing

Event	Action
CS falling edge	Start reading and freeze output buffer
CS rising edge	Release of the output buffer

Figure 9 shows a diagram of a full SPI angle reading. Figure 10 shows a diagram of a partial SPI angle reading. A full angle reading requires 16 clock pulses. The sensor MISO line returns:

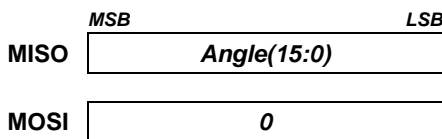

The MagAlpha family has sensors with different features and levels of resolution. Check the data output length in the General Characteristics table on page 5 for the number of useful bits delivered at the serial output. If the data length is smaller than 16, the rest of bits sent are 0.

For example, a data output length of 12 bits means that the serial output delivers a 12-bit angle value with 4 bits of 0 padded at the end (MISO state remains 0). If the master sends 16 clock counts, the MagAlpha replies with the following:

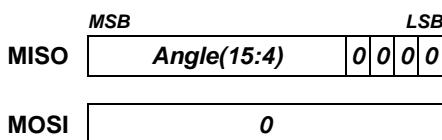

Reducing the number of clock counts can therefore optimize angle reading without any information loss. In the case of a 12-bit data output length, only 12 clock counts are required to get the full sensor resolution.

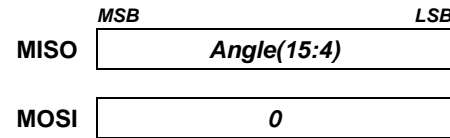

If less resolution is needed, the angle can be read by sending even fewer clock counts (since MSB is first).

In the case of fast reading, the MagAlpha keeps sending the same data until the data is refreshed (see the refresh rate in the General Characteristics table on page 5).

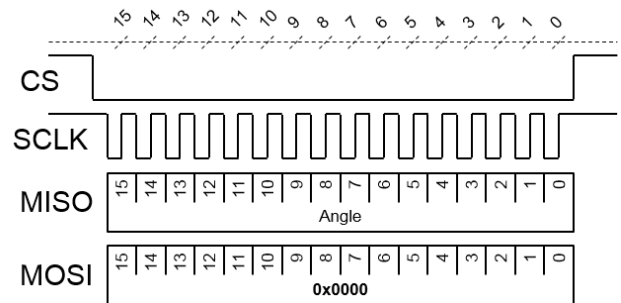

Figure 9: Diagram of a Full 16-Bit SPI Angle Reading

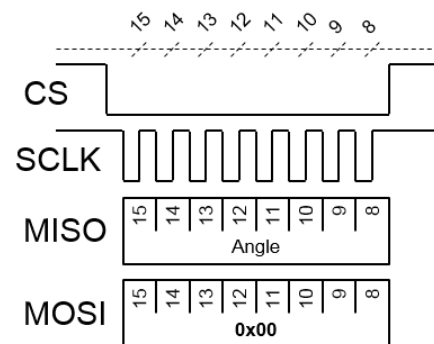
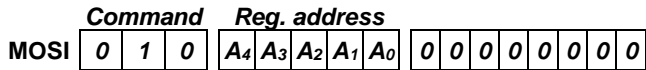
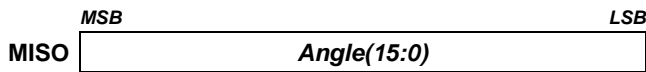

Figure 10: Diagram of a Partial 8-Bit SPI Angle Reading

SPI Read Register

A read register operation is constituted of two 16-bit frames. The first frame sends a read request, which contains the 3-bit read command (010) followed by the 5-bit register address. The last 8 bits of the frame must all be set to 0. The second frame returns the 8-bit register value (MSB byte).

The first 16-bit SPI frame (read request) is:



The second 16-bit SPI frame (response) is:

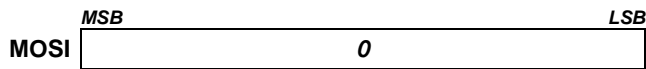
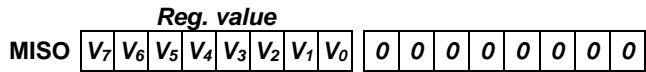
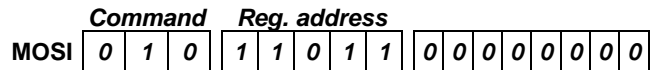
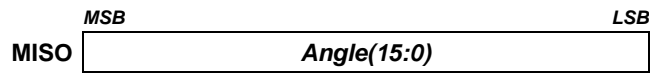

Figure 11 shows a complete transmission overview.

For example, to get the values of the magnetic level high and low flags (MGH and MGL), read register 27 (bit 6, bit 7) by sending the following first frame:



In the second frame, the MagAlpha replies:

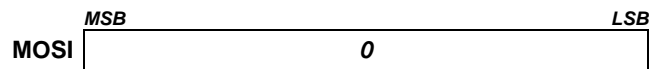
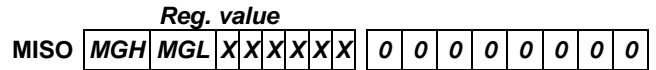

Figure 12 shows a complete example overview.

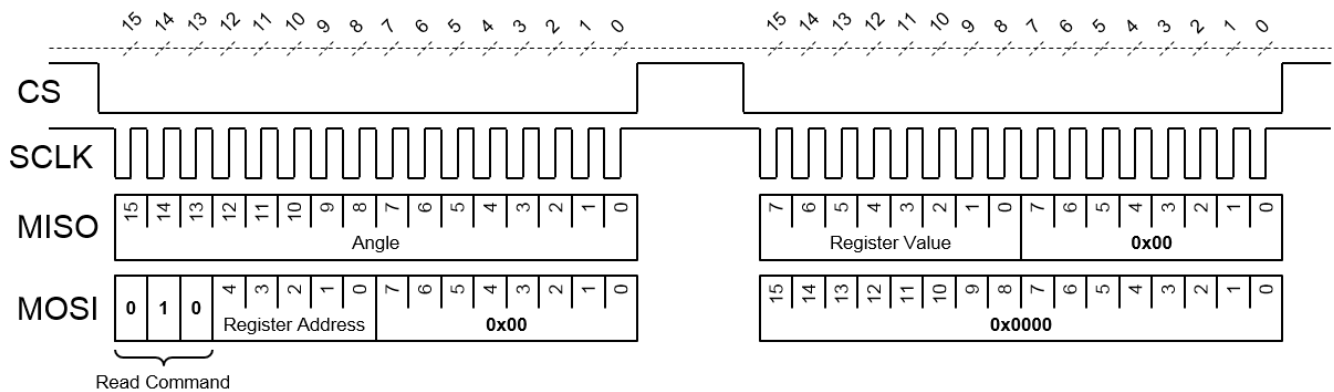

Figure 11: Two 16-Bit Frames Read Register Operation

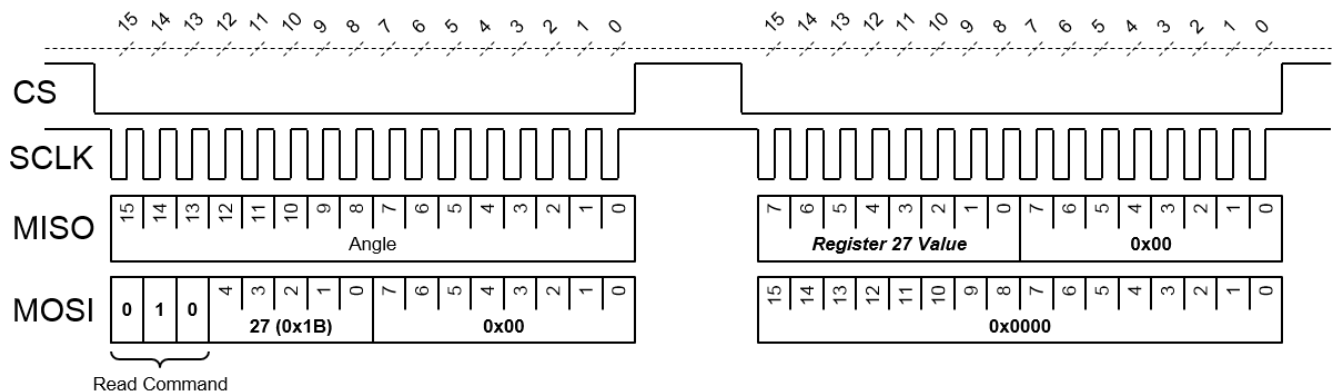

Figure 12: Example Read Magnetic Level Flags High and Low (MGH, MGL) on Register 27, Bit 7 to Bit 6

SPI Write Register

Table 5 shows the programmable 8-bit registers. Data written to these registers is stored in the on-chip, non-volatile memory, and is reloaded automatically during power on. Table 6 shows the factory default register values.

A write register operation is composed of two 16-bit frames. The first frame sends a write request, which contains the 3-bit write command (100) followed by the 5-bit register address and the 8-bit value (MSB first). The second frame returns the newly written register value (acknowledge).

The on-chip memory is guaranteed to endure 1,000 write cycles at 25°C.

It is important to wait 20ms between the first and the second frame. This is the time taken to write the non-volatile memory. Failure to implement this wait period results in the register’s previous value being read. Note that this delay is only required after a write request. A read register request and read angle do not require this wait time.

The first 16-bit SPI frame (write request) is:

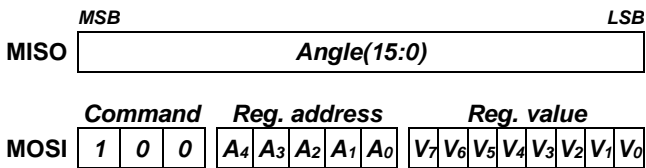

The second 16-bit SPI frame (response) is:

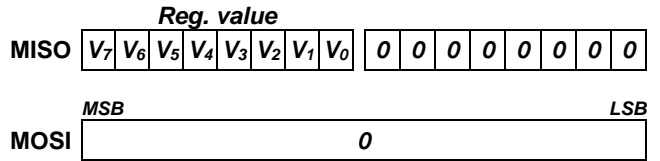

The readback register content can be used to verify the register programming. Figure 13 shows a complete transmission overview.

For example, to set the value of the output rotation direction (RD) to counterclockwise (high), write register 9 by sending the following first frame:

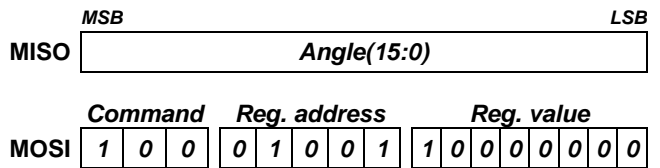

Send the second frame after a 20ms wait time. If the register is written correctly, the reply is:

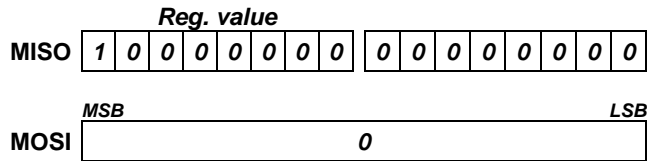

Figure 14 shows a complete example.

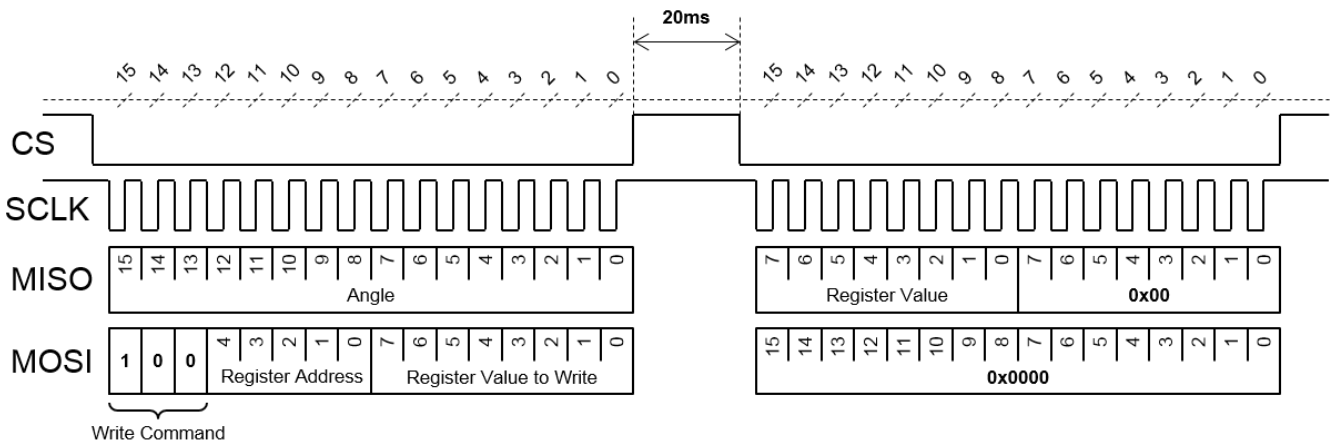

Figure 13: Overview of Two 16-Bit Frames Write Register Operation

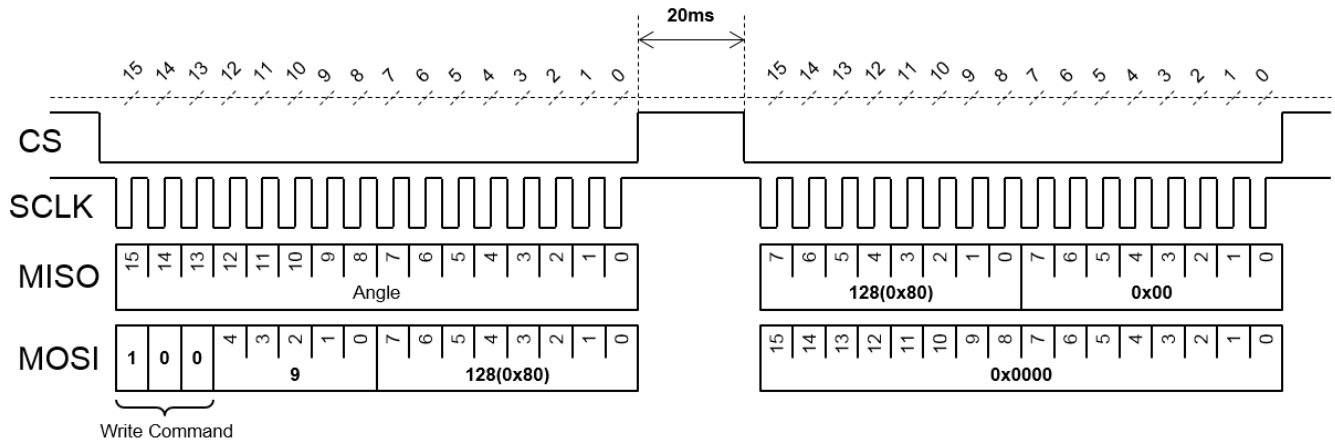

Figure 14: Example Write Output Rotation Direction (RD) to Counterclockwise (High), on Register 9, Bit 7

REGISTER MAP
Table 5: Register Map

No	Hex	Bin	Bit 7 MSB	Bit 6	Bit 5	Bit 4	Bit 3	Bit 2	Bit 1	Bit 0 LSB
0	0x0	00000	Z(7:0)							
1	0x1	00001	Z(15:8)							
2	0x2	00010	BCT(7:0)							
3	0x3	00011	-	-	-	-	-	-	ETY	ETX
4	0x4	00100	PPT(1:0)		ILIP(3:0)			-	-	
5	0x5	00101	PPT(9:2)							
6	0x6	00110	MGLT(2:0)			MGHT(2:0)			-	-
7	0x7	00111	NPP(2:0)			-	-	-		
9	0x9	01001	RD	-	-	-	-	-	-	-
14	0xE	01110	FW(7:0)							
16	0x10	10000	HYS(7:0)							
27	0x1B	11011	MGH	MGL	-	-	-	-	-	-

Table 6: Factory Default Values

No	Hex	Bin	Bit 7 MSB	Bit 6	Bit 5	Bit 4	Bit 3	Bit 2	Bit 1	Bit 0 LSB
0	0x0	00000	0	0	0	0	0	0	0	0
1	0x1	00001	0	0	0	0	0	0	0	0
2	0x2	00010	0	0	0	0	0	0	0	0
3	0x3	00011	0	0	0	0	0	0	0	0
4	0x4	00100	1	1	0	0	0	0	0	0
5	0x5	00101	1	1	1	1	1	1	1	1
6	0x6	00110	0	0	0	1	1	1	0	0
7	0x7	00111	0	0	0	0	0	0	0	0
9	0x9	01001	0	0	0	0	0	0	0	0
14	0xE	01110	0	1	1	1	0	1	1	1
16	0x10	10000	1	0	0	1	1	1	0	0

Table 7: Programming Parameters

Parameters	Symbol	Number of Bits	Description	See
Zero setting	Z	16	Sets the zero position	Table 8
Bias current trimming	BCT	8	For side-shaft configuration. Reduces the bias current of the X or Y Hall device	Table 11
Enable trimming X	ETX	1	Biased current trimmed in the X-direction Hall device	Table 12
Enable trimming Y	ETY	1	Biased current trimmed in the Y-direction Hall device	Table 12
Pulses per turn	PPT	10	Number of pulses per turn of the ABZ output	Table 15
Index length/position	ILIP	4	Parametrization of the ABZ index pulse	Figure 23
Magnetic field high threshold	MGHT	3	Sets the field strength high threshold	Table 14
Magnetic field low threshold	MGLT	3	Sets the field strength low threshold	Table 14
Number of pole pairs	NPP	3	UVW cycles per turn for motor commutation	Table 19
Rotation direction	RD	1	Determines the sensor positive direction	Table 10
Filter window	FW	8	Size of the digital filter window	Table 15
Hysteresis	HYS	8	Hysteresis of the ABZ output	Table 18

REGISTER SETTINGS

Zero Setting

The zero position of the MagAlpha (a_0) can be programmed with 16 bits of resolution. The angle streamed out by the MagAlpha (a_{out}) is calculated with Equation (2):

$$a_{out} = a_{raw} - a_0 \quad (2)$$

Where a_{raw} is the raw angle provided by the MagAlpha front-end.

The parameter Z(15:0), which is 0 by default, is the complementary angle of the zero setting. In decimals, it can be determined using Equation (3):

$$a_0 = 2^{16} - Z(15:0) \quad (3)$$

Table 8 shows the zero setting parameter.

Table 8: Zero Setting Parameter

Z(15:0)	Zero Position a_0 (16-bit dec)	Zero Position a_0 (deg)
0	65536	360.000
1	65535	359.995
2	65534	359.989
...
65534	2	0.011
65535	1	0.005

Example

To set the zero position to 20 degrees, the Z(15:0) parameter is equal to the complementary angle, and can be calculated with Equation (4):

$$Z(15:0) = 2^{16} - \frac{20\text{deg}}{360\text{deg}} 2^{16} = 61895 \quad (4)$$

In binary, it is written as 1111 0001 1100 0111.

Table 9 shows the content of registers 0 and 1.

Table 9: Register Content

Reg	Bit 7	Bit 6	Bit 5	Bit 4	Bit 3	Bit 2	Bit 1	Bit 0
0	1	1	0	0	0	1	1	1
1	1	1	1	1	0	0	0	1

Rotation Direction

By default, when looking at the top of the package, the angle increases when the magnetic field rotates clockwise (CW) (see Figure 15 and Table 10).

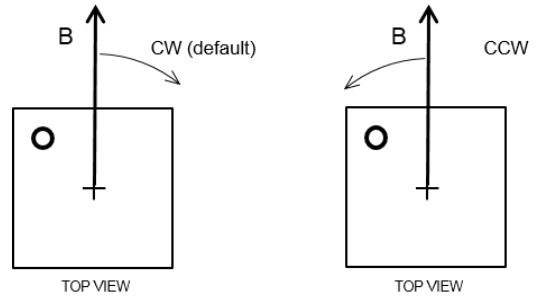

Figure 15: Positive Rotation Direction of the Magnetic Field

Table 10: Rotation Direction Parameter

RD	Positive Direction
0	Clockwise (CW)
1	Counterclockwise (CCW)

BCT Settings (Bias Current Trimming)

Side-Shaft

When the MA330 is mounted on the side of the magnet, the relationship between the field angle and the mechanical angle is no longer directly linear. This effect is related to the fact that the tangential magnetic field is usually smaller than the radial field. Define the field ratio k with Equation (5):

$$k = B_{rad} / B_{tan} \quad (5)$$

Where B_{rad} is the maximum radial magnetic field, and B_{tan} is the maximum tangential magnetic field (see Figure 16).

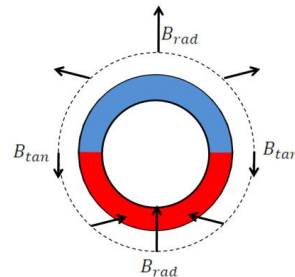

Figure 16: Side-Shaft Field

The ratio k depends on the magnet geometry and distance to the sensor. Having a k ratio different than 1 results in the sensor output response not being linear with respect to the mechanical angle. Note that the error curve has the shape of a double sinewave (see Figure 18). E is the amplitude of this error.

The X-axis or the Y-axis bias current can be reduced to recover an equal Hall signal for all angles and suppress the error. The ETX and ETY parameters control the direction in which the sensitivity is reduced. The current reduction is set by the parameter bias current trimming BCT(7:0), which is an integer from 0 to 255.

In side-shaft configuration (i.e. the sensor center is located beyond the magnet’s outer diameter), k is greater than 1. For optimal compensation, the sensitivity of the radial axis should be reduced by setting the BCT parameter, calculated with Equation (6):

$$BCT(7:0) = 258 \left(1 - \frac{1}{k} \right) \quad (6)$$

Equation (6) is plotted in Figure 17 and Table 11.

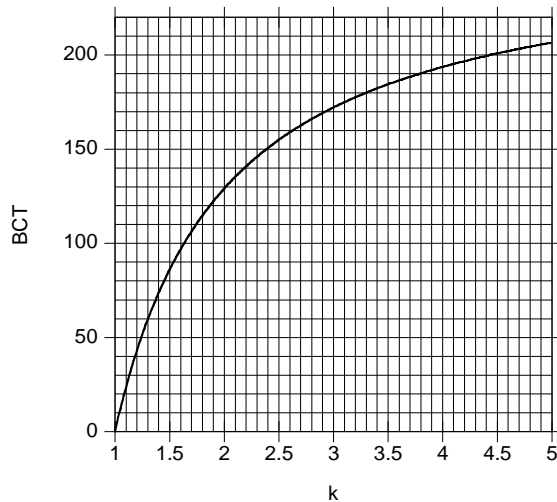

Figure 17: Relationship between the k Ratio and the Optimal BCT to Recover Linearity

Table 11: Example of BCT Settings

E (deg)	Magnet Ratio k	BCT (7:0)
0	1.0	0
11.5	1.5	86
19.5	2.0	129
25.4	2.5	155
30.0	3.0	172
33.7	3.5	184
36.9	4.0	194
39.5	4.5	201
41.8	5.0	207

Determining k with the MagAlpha

It is possible to deduce the k ratio from the error curve obtained with the default BCT setting (BCT = 0). For this purpose, rotate the magnet over one revolution and record the MagAlpha output. Then plot the error curve (the MagAlpha output minus the real mechanical position vs. the real mechanical position) and extract two parameters: the maximum error E and the position of this maximum with respect to a zero crossing a_m (see Figure 18). k can be calculated with Equation (7):

$$k = \frac{\tan(E + a_m)}{\tan(a_m)} \quad (7)$$

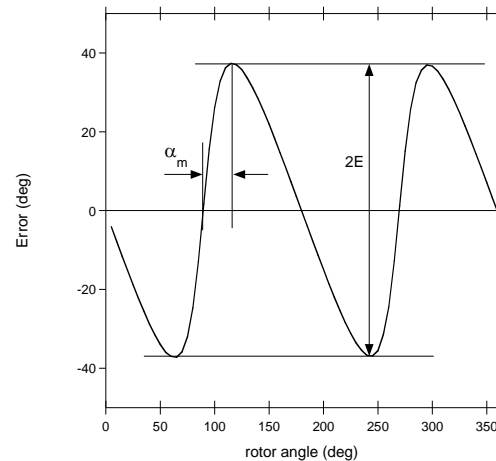

Figure 18: Error Curve in Side-Shaft Configuration with BCT = 0

Table 11 shows some examples. Alternately, k can be obtained from the graph of Figure 19.

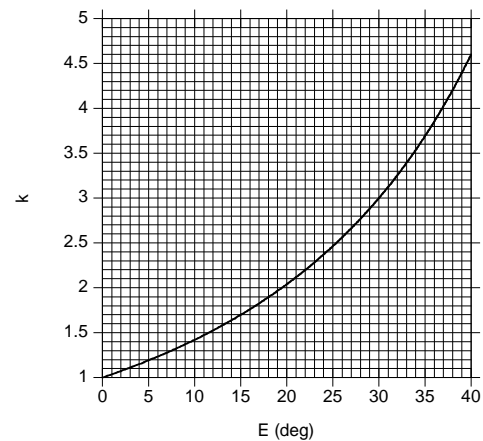

Figure 19: Relationship between the Error Measured with BCT = 0 and the Magnet Ratio k

Sensor Orientation

The dot marked on the package shows whether the radial field is aligned with the sensor coordinate X or Y (see Figure 20).

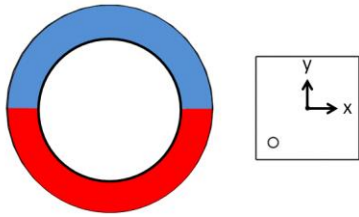

Figure 20: Package Top View with X and Y Axes

Determine which axis needs to be reduced (see the qualitative field distribution around a ring in Figure 16). For example, with the arrangement depicted in Figure 20, the field along the sensor Y direction is tangential and weaker. Therefore, the X-axis should be reduced (ETX = 1 and ETY = 0). Note that if both ETX and ETY are set to 1, the current bias is reduced in both directions the same way (i.e. without side-shaft correction).

Table 12: Trimming Direction Parameters

ETX	Enable Trimming of the X-Axis
0	Disabled
1	Enabled
ETY	Enable Trimming of the Y-Axis
0	Disabled
1	Enabled

Magnetic Field Thresholds

The magnetic flags (MGL and MGH) indicate that the magnetic field at the sensor position is out of range, defined by the lower and upper magnetic field thresholds, respectively MGLT and MGHT (see Figure 21).

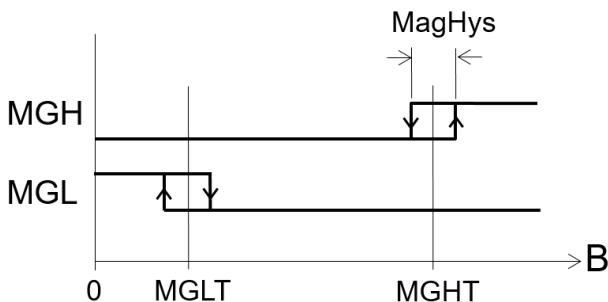

Figure 21: MGH and MGL Signals as a Function of the Field Strength

MagHys, the typical hysteresis on the MGH and MGL signals, is 6mT (see Figure 24). The MGLT

and MGHT thresholds are coded on 3 bits and stored in register 6 (see Table 13).

Table 13: Register 6

Register 6							
Bit 7	Bit 6	Bit 5	Bit 4	Bit 3	Bit 2	Bit 1	Bit 0
MGLT			MGHT			-	-

The 3-bit values of MGLT and MGHT correspond to the magnetic field (see Table 14).

Table 14: MGLT and MGHT Binary to mT Relationship

MGLT or MGHT ⁽⁸⁾	Field Threshold in mT ⁽⁷⁾	
	From Low to High Magnetic Field	From High to Low magnetic Field
000	26	20
001	41	35
010	56	50
011	70	64
100	84	78
101	98	92
110	112	106
111	126	120

Notes:

- 7) Valid for VDD = 3.3V. If different, then the field threshold is scaled by the factor VDD / 3.3V.
- 8) MGLT can have a larger value than MGHT.

The MGL and MGH alarm flags can be read in register 27 (bit 6 and bit 7), and their logic state is also given at digital output pins 11 and 16.

To read the MGL and MGH flags by SPI, send the following 8-bit write command to register 27:

Command	Reg. address	MSB	Value	LSB
0 1 0	1 1 0 1 1	0	0 0 0 0 0 0 0 0	0

The MA330 answers with the register 27 content in the next transmission:

Register 27 [7:0]							
MGH	MGL	x	x	MG1L	MG2L	x	x

The logic state of the MGL and MGH flags has no effect on the angle output.

MGL Application Note

Pulses with a duration of about 1.3µs to 1.5µs appear randomly in the MGL signal. They appear on both the pin and register values (Register 27, bit 6).

These pulses appear around angle values of 44, 138, 224, and 318 degrees (sensor output) or in an interval of ±1.5 degrees around these values.

These pulses have an amplitude of 3.3V (VDD). The minimum interval between two pulses is 100µs.

MGL Workarounds

1. Invert the MGH signal to replace MGL. The MGL and MGH magnetic thresholds only differ by a small hysteresis (see Table 14 on page 21). An inverted MGH signal can be used to replace the MGL output in the application.
2. Read the MGL signal level twice. Using two readings, which must be between 2µs and 100µs apart, allows the user to distinguish erroneous from real transitions. Table 15 shows examples of different cases.
3. Read register 27 with the SPI and compute a corrected MGL value using MG1L and MG2L. The corrected MGL signal = not (MG1L OR MG2L). This means that the corrected MGL must be set to 1 only when both MG1L and MG2L are equal to 0. See the C implementation below:

```
correctedMGL = !(MG1L | MG2L)
```

Table 15: MGL Multiple Reading Workaround

	MGL First Reading	MGL Second Reading (e.g. 20µs After the First Reading)	True MGL Value
Case 1	0	Second reading is not needed	0
Case 2	1	1	1
Case 3	1	0	0

Filter Window

The filter window affects the effective resolution (defined as the ±3σ noise interval) and the output bandwidth, which is characterized by the cutoff frequency. Table 16 shows the resulting resolution and bandwidth for each window.

Table 16: FW

FW(7:0)	Time Const. τ (µs)	Effective Resolution at 45mT (bits)	f _{CUTOFF} (Hz)	Power-Up Time (ms)
51	64	9.5	6000	0.5
68	128	10	3000	1.1
85	256	10.5	1500	2.5
102	512	11	740	5.5
119 (default)	1024	11.5	370	12
136	2048	12	185	26
153	4096	12.5	93	57
170	8192	13	46	123
187	16384	13.5	23	264

The time constant τ is the parameter entering in the transfer function (1). This allows the user to accurately model the system and, most importantly, analyze the stability of a control loop.

ABZ Incremental Encoder Output

The MA330 ABZ output emulates a 12-bit incremental encoder (such as an optical encoder) by providing logic pulses in quadrature (see Figure 22). Compared to signal A, signal B is shifted by 1/4 of the pulse period. Over one revolution, signal A pulses *n* times, where *n* is programmable from 1 to 1024 pulses per revolution. The number of pulses per channel per revolution is programmed by setting the parameter PPT, which consists of 8 bits split between registers 0x4 and 0x5 (see Table 5). The factory default value is 1023. Table 17 shows how to program PPT(9:0) to set the required resolution.

Table 17: PPT

PPT(9:0)	Pulses per Revolution	Edges per Revolution	
000000000	1	4	MIN
000000001	2	8	
000000010	3	12	
000000011	4	16	
...
111111100	1021	4084	
111111101	1022	4088	
111111110	1023	4092	
111111111	1024	4096	MAX

For example, to set 120 pulses per revolution (480 edges), set PPT to 120 - 1 = 119 (binary: 0001110111). Table 18 on page 23 shows how to set registers 4 and 5.

Table 18: Register 4 and Register 5

	B7	B6	B5	B4	B3	B2	B1	B0
R4	1	1	0	0	0	0	0	0
R5	0	0	0	1	1	1	0	1

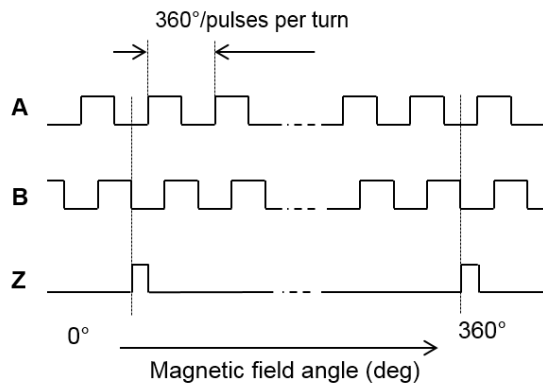
Figure 22: Timing of the ABZ Output

Signal Z (zero or index) raises only once per turn at the zero angle position.

The position and length of the Z pulse is programmable via bit ILIP(3:0) in register 0x4 (see Figure 23).

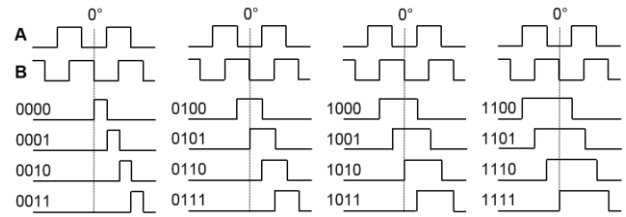
Figure 23: ILIP Parameter Effect on Index Shape

By default, the ILIP parameter is 0000. The index rising edge is aligned with the channel B falling edge, and the index length is half the A or B pulse length.

ABZ Hysteresis

The hysteresis is set by the HYS parameter (see Table 19). To avoid spurious transitions, it is highly recommended that the hysteresis be 12 times greater than the output RMS noise ($= 1\sigma$) (see Figure 27). Table 20 shows indications of the 1σ noise.

Table 19: HYS

HYS(7:0)	Hysteresis (deg)
200	0.08
188	0.14
148	0.18
152	0.36
156 (default)	0.52
116	0.70
120	1.4
124	2.1
84	2.8

Table 20: RMS Noise

FW(7:0)	Effective Resolution at 45mT (bits)	1 σ Noise (deg)
51	9.5	0.08
68	10	0.06
85	10.5	0.04
102	11	0.03
119 (default)	11.5	0.02
136	12	0.015
153	12.5	0.01
170	13	0.007
187	13.5	0.005

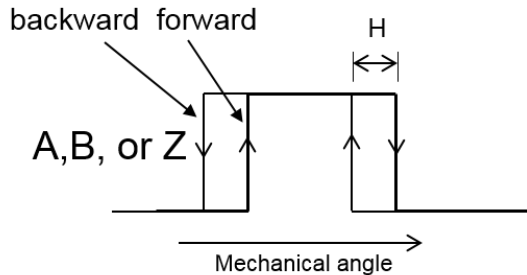
Figure 24: Hysteresis of the Incremental Output
ABZ Jitter

The ABZ state is updated at a frequency of 16MHz, enabling accurate operation up to a very high rpm (above 10⁵rpm).

The jitter characterizes how far a particular ABZ edge can occur at an angular position different from the ideal position (see Figure 25).

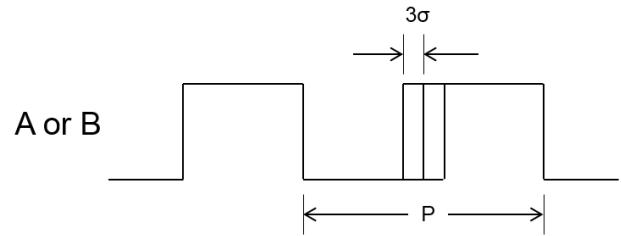
Figure 25: ABZ Jitter

The measurable jitter is composed of the random jitter and the systematic jitter (i.e. always the same deviation at a given angle, and given in the General Characteristics table on page 5).

The random jitter reflects the sensor noise, so the edge distribution is the same as the SPI output noise.

The random jitter is a function of the rotation speed. At lower speeds, the random jitter is smaller than the sensor noise (see the Typical Characteristics curves on page 7).

This is a consequence of the fact that the probability of measuring an edge at a certain distance from the ideal position depends on the number of ABZ updates at this position.

Block Commutation – UVW

The UVW output emulates the three Hall switches, usually used for the block commutation of a three-phase electric motor. The three logic signals have a duty cycle of 50%, and are shifted by 60° relative to each other (see Figure 26).

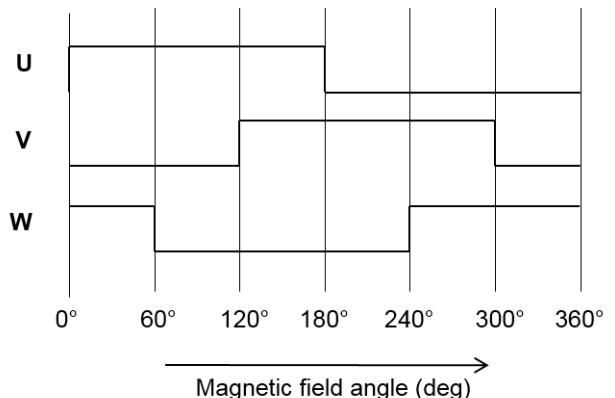
Figure 26: UVW Output for Single-Pole Pair Rotor during Rotation

If the number of motor pole pairs exceeds the number of target magnet pole pairs, the MA330 is able to generate more than one UVW cycle per revolution. It does this by dividing the digital angle into the required number of commutation steps per 360° revolution. The parameter NPP(2:0) in register 0x7 sets the number of pole pairs emulated, and the corresponding commutation step angle for the UVW signals. Table 21 describes the pole pair configuration options.

Table 21: Number of UVW Pair Poles

NPP (2:0)	Pole Pairs	States per Revolution	State Width (deg)
000	1	6	60
001	2	12	30
010	3	18	20
011	4	24	15
100	5	30	12
101	6	36	10
110	7	42	8.6
111	8	48	7.5

Figure 27 shows an example of the 30° UVW commutation signal spacing for a four-pole (dipole pair) motor.

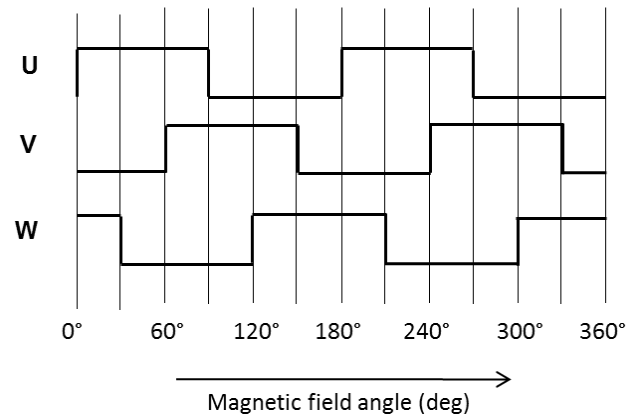

Figure 27: UVW Commutation Signals for a Four-Pole (Dipole Pair) Motor

UVW Hysteresis

A hysteresis larger than the output noise is introduced on the UVW output to avoid any spurious transitions (see Figure 28).

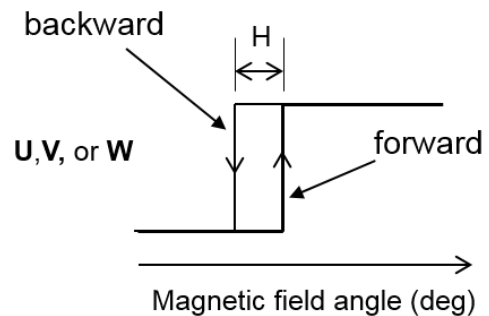

Figure 28: Hysteresis of the UVW Signal

TYPICAL APPLICATION CIRCUITS

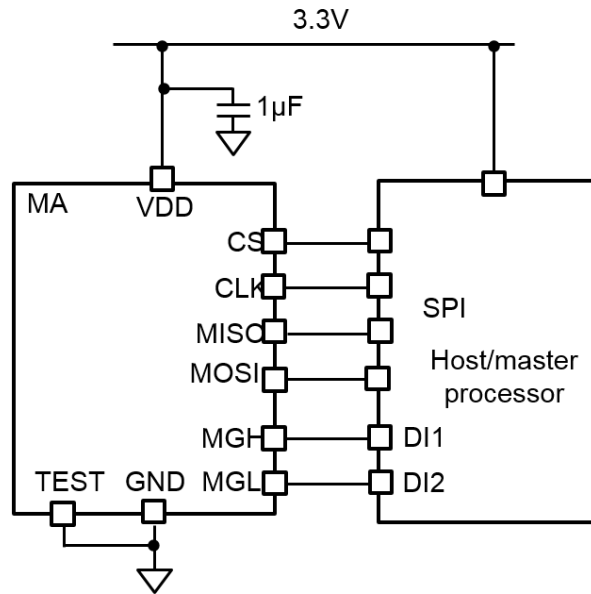

Figure 29: Typical Configurations Using SPI Interface and MGH/MGL Signals

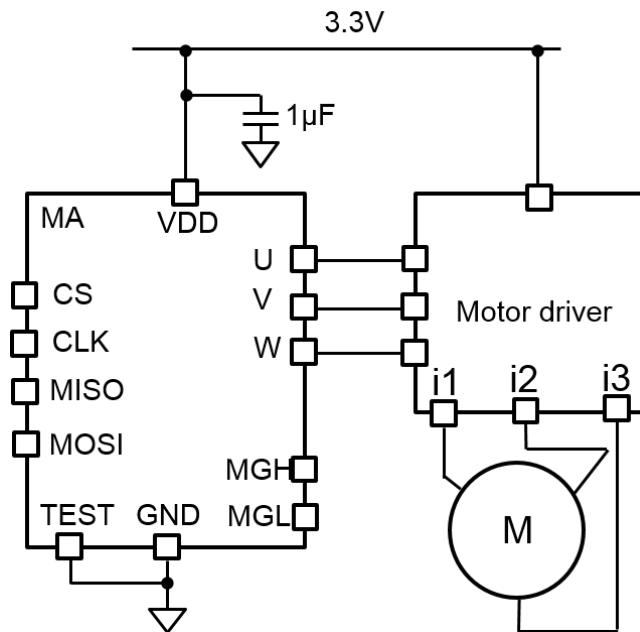
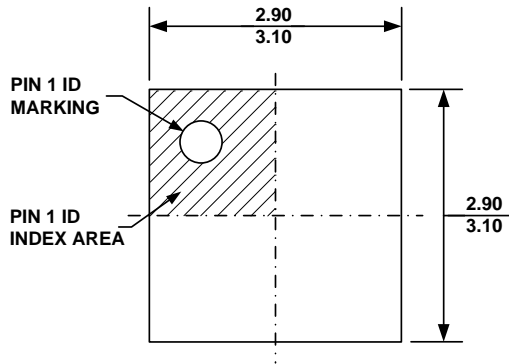

Figure 30: Typical Motor Configuration Using UVW Commutation Signals

PACKAGE INFORMATION

QFN-16 (3mmx3mm)



TOP VIEW

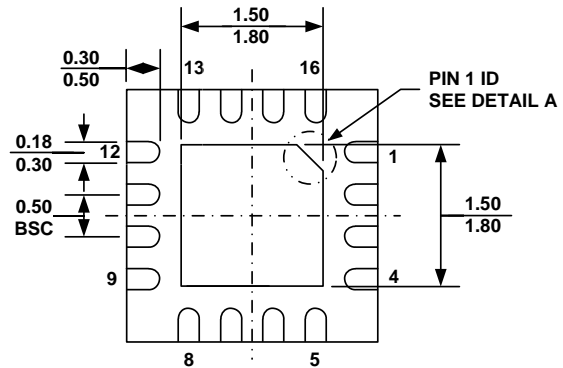

BOTTOM VIEW

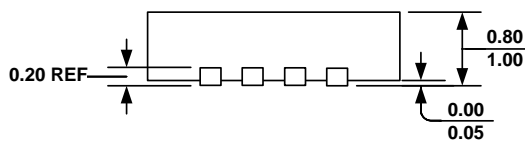

SIDE VIEW

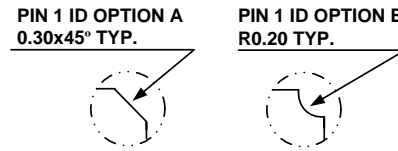

DETAIL A

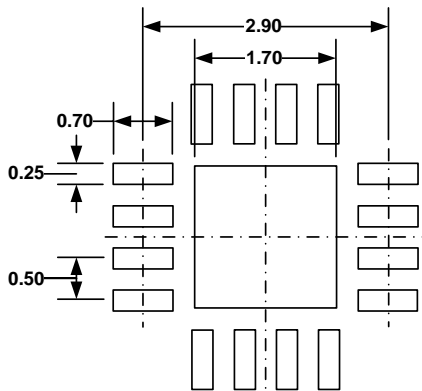

RECOMMENDED LAND PATTERN

NOTE:

- 1) ALL DIMENSIONS ARE IN MILLIMETERS.
- 2) EXPOSED PADDLE SIZE DOES NOT INCLUDE MOLD FLASH.
- 3) LEAD COPLANARITY SHALL BE 0.10 MILLIMETER MAX.
- 4) DRAWING CONFORMS TO JEDEC MO-220, VARIATION VEED-4.
- 5) DRAWING IS NOT TO SCALE.

APPENDIX A: DEFINITIONS

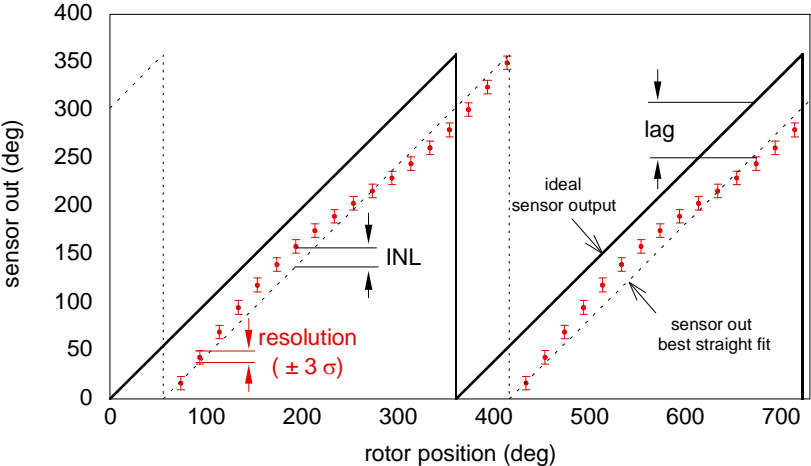
Effective Resolution (3σ Noise Level)	Smallest angle increment distinguishable from the noise. The resolution is measured by computing three times σ (the standard deviation in degrees) taken over 1,000 data points at a constant position. The resolution in bits is obtained with: $\log_2(360 / 6\sigma)$.
Refresh Rate	Rate at which new data points are stored in the output buffer.
ABZ Update Rate	Rate at which a new ABZ state is computed. The inverse of this rate is the minimum time between two ABZ edges.
Latency	Time elapsed between the instant when the data is ready to be read and the instant at which the shaft passes that position. The lag in degrees is $lag = latency \cdot v$, where v is the angular velocity in deg/s.
Power-Up Time	Time until the sensor delivers valid data starting at power-up.
Integral Nonlinearity (INL)	<p>Maximum deviation between the average sensor output (at a fixed position) and the true mechanical angle.</p>  <p>INL can be obtained from the error curve $err(a) = out(a) - a$, where $out(a)$ is the average over 1000 sensor output, and a is the mechanical angle indicated by a high-precision encoder (<0.001 deg). INL is then calculated with Equation (A1):</p> $INL = \frac{\max(err(a)) - \min(err(a))}{2} \quad (A1)$
Drift	Angle variation rate when one parameter is changed (e.g. temperature, VDD) and all the others, including the shaft angle, remain constant.

APPENDIX B: SPI COMMUNICATION CHEATSHEET

Read Angle

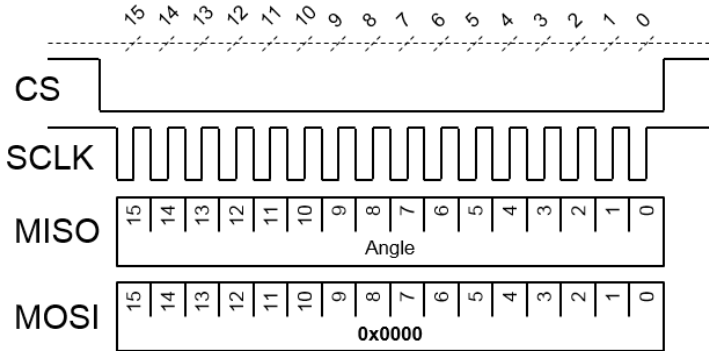

Read Register

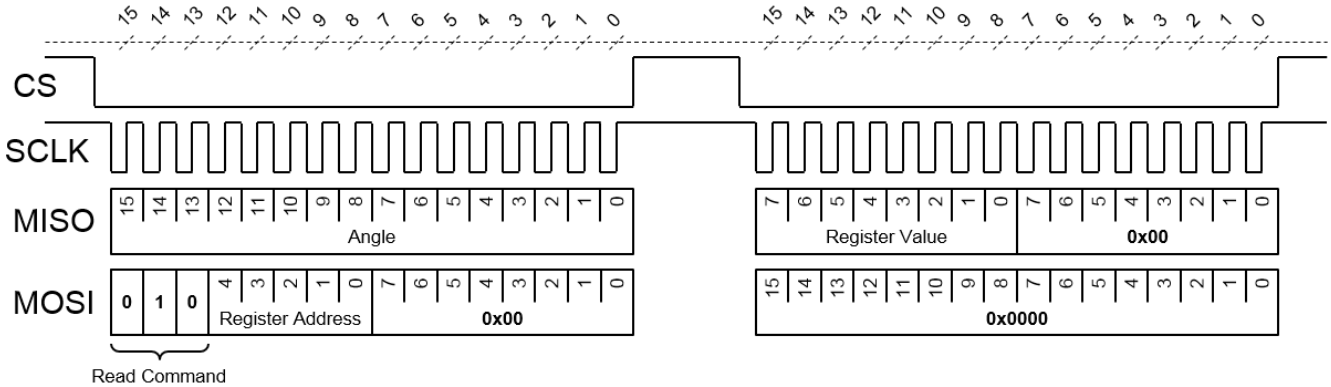

Write Register

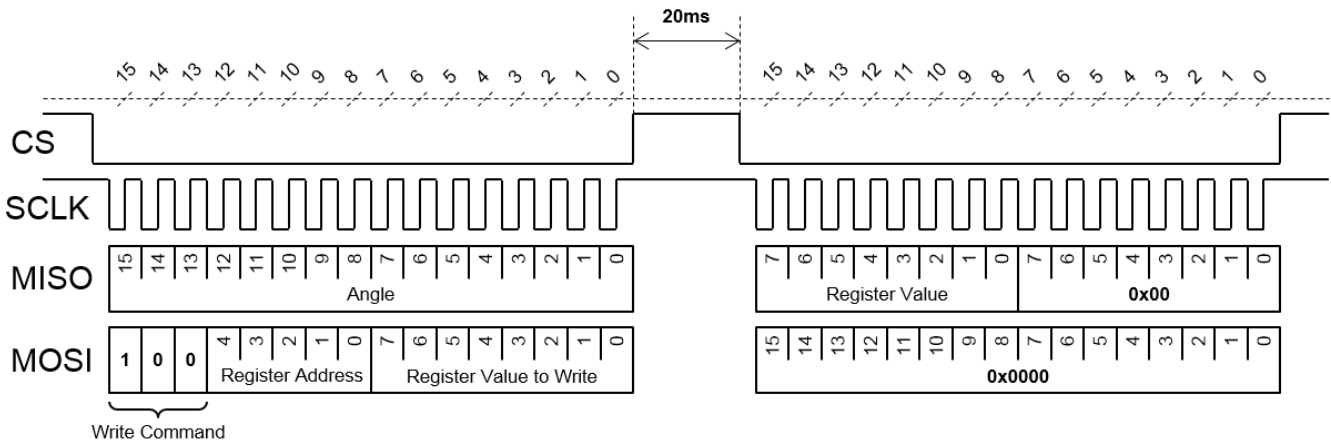

Notice: The information in this document is subject to change without notice. Users should warrant and guarantee that third-party Intellectual Property rights are not infringed upon when integrating MPS products into any application. MPS will not assume any legal responsibility for any said applications.

REVISION HISTORY

Revision #	Revision Date	Description	Pages Updated
1.0	7/24/2019	Initial Release	-
1.1	8/8/2022	Updated orderable suffix from “-Z” to “-Z”.	2
		Updated ABZ Jitter plot.	7
		Updated Figure 21.	21
		Added MGL Application Note and MGL Workarounds sections and Table 15.	21–22
		Minor formatting updates.	All

Notice: The information in this document is subject to change without notice. Users should warrant and guarantee that third-party Intellectual Property rights are not infringed upon when integrating MPS products into any application. MPS will not assume any legal responsibility for any said applications.