

Evaluation Board Report

12V 0.12W ACDC power supply

Design Specs	Value	Unit
Input Voltage	85-265	VAC
Output Voltage	12	VDC
Output Current	10	mA
Isolation	No	
MPS IC	MP100GN	
Application	<ul style="list-style-type: none"> • Wall Switches and Dimmers • AC/DC Power Supply for Wireless System, like ZigBee, Z-Wave etc. • Standby Power for General Off-Line Applications 	
Document Number	EBXXX	
Author	Application Engineering Department	
Date	Nov, 2014	
Revision	1.0	

Design Summary

EV100-N-00A evaluation board provides a reference design for a universal offline inductor-less power supply with 12V, 10mA output. It contains the complete specification of the power supply, a detailed circuit diagram, the entire bill of materials required to build the power supply, drawing of the power inductors and transformers, and test data of the most important performance.

DESCRIPTION

The MP100 is a compact, inductor-less, good-efficiency, off-line regulator. It steps down the AC line voltage to an adjustable DC output. It is a simple solution to provide a bias voltage to ICs in off-line applications. Its integrated smart-control system uses AC line power only when necessary, thus minimizing device losses to achieve good efficiency. This device can help system designs meet new standby power specifications.

The MP100 provides various protections, such as over-current protection, short-circuit protection, VD over-voltage protection, VD under-voltage lockout, and thermal shutdown.

The MP100 is available in a SOIC8E package.

ELECTRICAL SPECIFICATION

Parameter	Symbol	Value	Units
Supply Voltage	V_{IN}	85-265	VAC
Output Voltage	V_{OUT}	12	V
Output Current	I_{OUT}	10	mA

FEATURES

- Universal AC Input (85Vac-305Vac)
- Smart Control to Maximize Efficiency
- Adjustable Output Voltage from 1.5V to 15V
- Low Component Count and Cost
- Thermal Shutdown Protection
- Short Circuit Protection
- Provide Power Good Signal
- Excellent EMI Performance

All MPS parts are lead-free and adhere to the RoHS directive. For MPS green status, please visit MPS website under Quality Assurance. "MPS" and "The Future of Analog IC Technology" are Registered Trademarks of Monolithic Power Systems, Inc.

EV100-N-00A EVALUATION BOARD



(L x W x H) 33mm x 29mm x 22mm

Board Number	MPS IC Number
EV100-N-00A	MP100GN

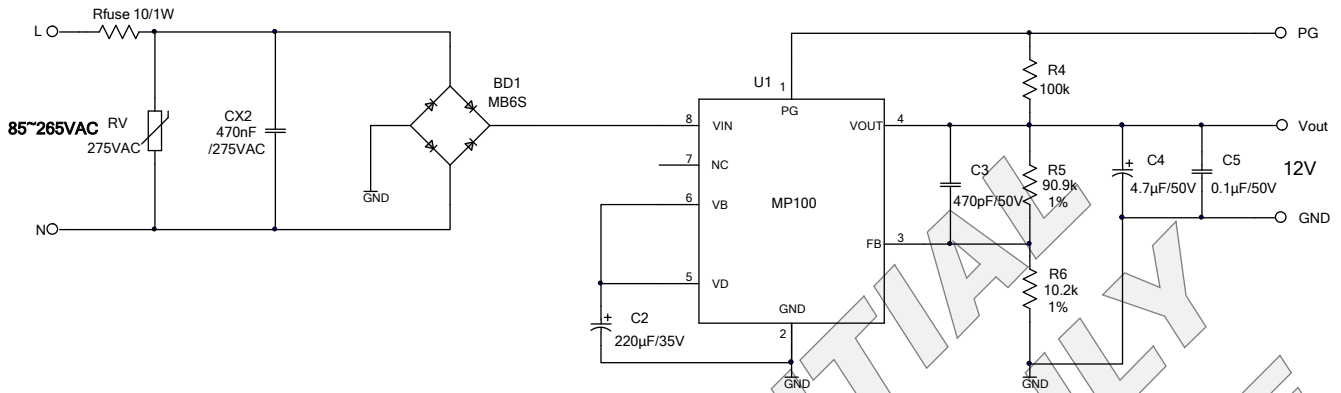
EVALUATION BOARD SCHEMATIC

Vout can be adjusted by choosing the value of R5 and R6, the relationship of them is:

$$V_{out} = 1.235V * (1 + R5/R6);$$

Table below gives the value need to get normally used output voltage:

Vout(V)	R5(kΩ)	R6(kΩ)
1.5	2.21(1%)	10.2(1%)
3.3	16.9(1%)	10.2(1%)
5	30.9(1%)	10.2(1%)
15	121(1%)	10.2(1%)

The maximum output power (P_{OUT}) of MP100 Vs input voltage (V_{IN}) is depicted by following chart for 12V ,5V and 3.3V output applications respectively considering full bridge and half bridge rectifier:

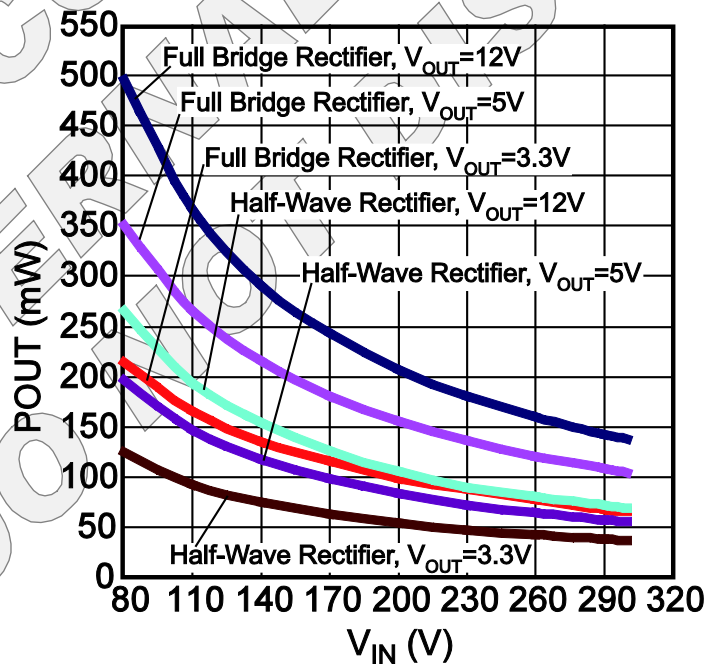

EV100-N-00A BILL OF MATERIAL

Qty	RefDes	Value	Description	Package	Manufacture	Manufacturer_PN
1	BD1	MB6S	Diode;600V;0.5A;	SOIC-4	TaiWan Semiconductor	MB6S
1	C2	220µF	Electrolytic Capacitor; 35V;	DIP	Jianghai	CD110-35V220
1	C3	470pF	Ceramic Capacitor; 50V;C0G;	0603	muRata	GRM1885C1H471JA01
1	C4	4.7µF	Electrolytic Capacitor; 50V;	DIP	Jianghai	CD287-50V4.7
1	C5	0.1µF	Ceramic Capacitor; 50V;X7R;	0603	TDK	C1608X7R1H104K
1	CX2	470nF	Film Capacitor; 275V;10%;	DIP	Kaili	PX474K31D42L270D9R
1	R4	100kΩ	Film Resistor;5%;	0603	Yageo	RC0603JR-07100KL
1	R5	90.9kΩ	Film Resistor;1%;	0603	Yageo	RC0603FR-0790K9L
1	R6	10.2kΩ	Film Resistor;1%;	0603	Yageo	RC0603FR-0710K2L
1	Rfuse	10Ω	Resistor;5%;1W	DIP	Bangdayuan	10 Ohm/1W
1	RV	275Vac	TVR10431KSY; 430V(1 mA);	DIP	TKS	TVR10431KSY
1	U1	MP100	Offline Regulator	SOIC8E	MPS	MP100GN

EVB TEST RESULTS

Performance waveforms are tested on the evaluation board.

$V_{OUT} = 12V$, $I_{OUT} = 10mA$, $T_A = 23^{\circ}C$, unless otherwise noted.

Efficiency vs. Load

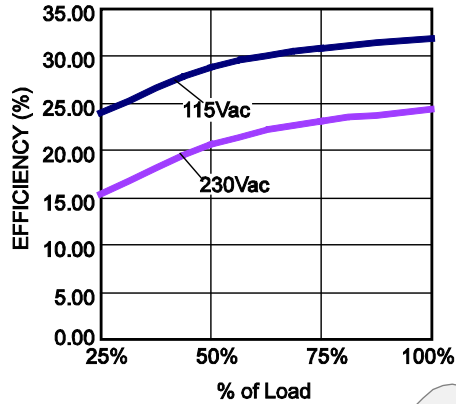

No Load Power vs. Input Voltage

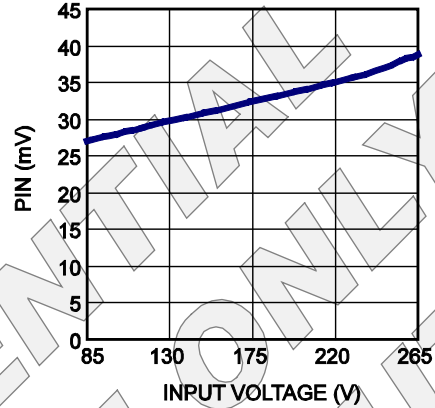

Steady State

$V_{IN} = 115Vac, 12V/10mA$

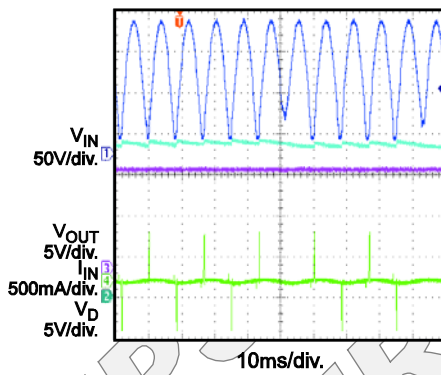

Steady State

$V_{IN} = 230Vac, 12V/10mA$

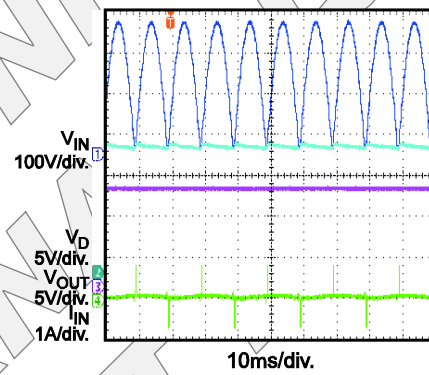

Output Voltage Ripple

$V_{IN} = 115Vac, 12V/0mA$

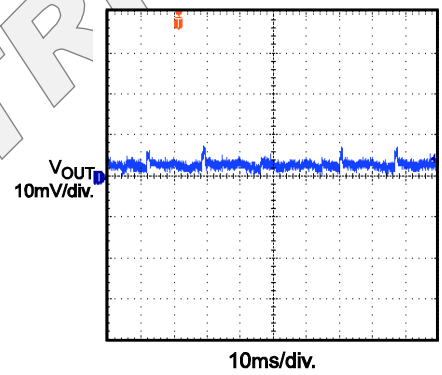

Output Voltage Ripple

$V_{IN} = 115Vac, 12V/10mA$

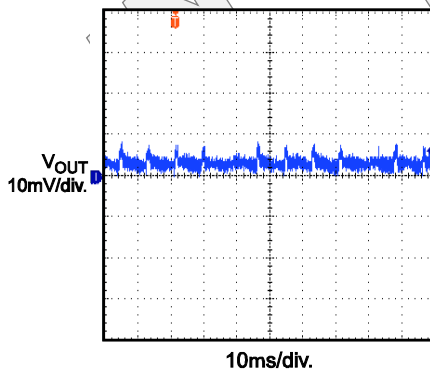

Output Voltage Ripple

$V_{IN} = 230Vac, 12V/0mA$

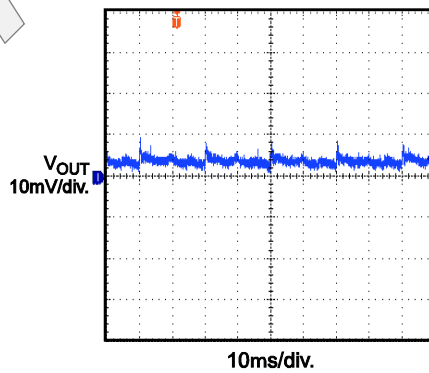

Output Voltage Ripple

$V_{IN} = 230Vac, 12V/10mA$

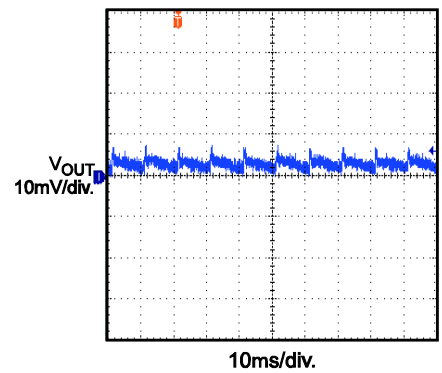

EVB TEST RESULTS *(continued)*

Performance waveforms are tested on the evaluation board.

 $V_{OUT} = 12V, I_{OUT} = 10mA, T_A = 23^{\circ}C$, unless otherwise noted.

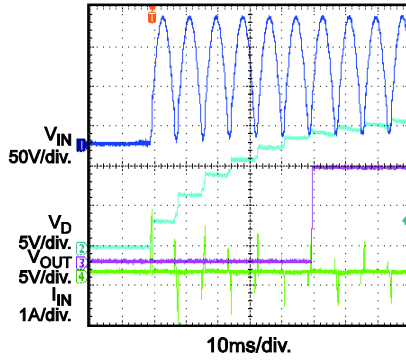
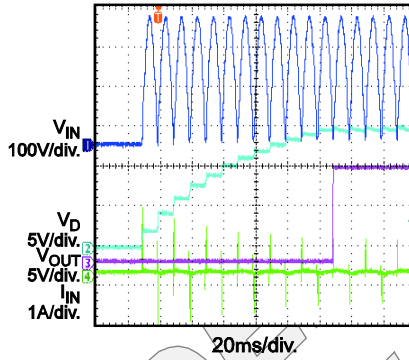
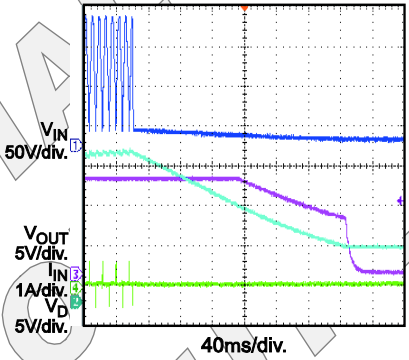
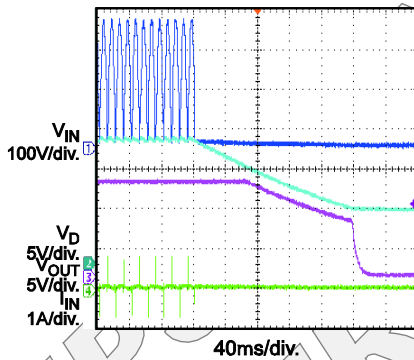
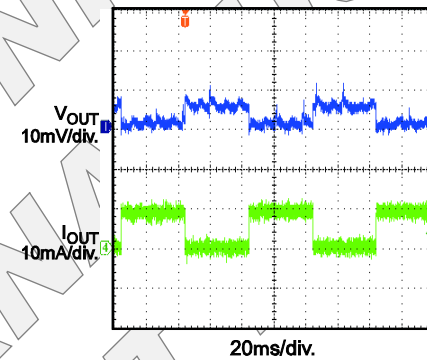
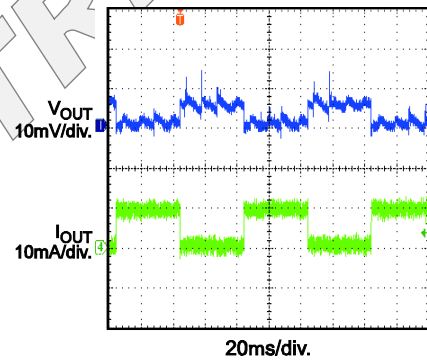
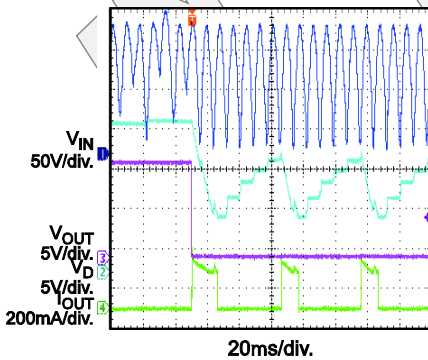
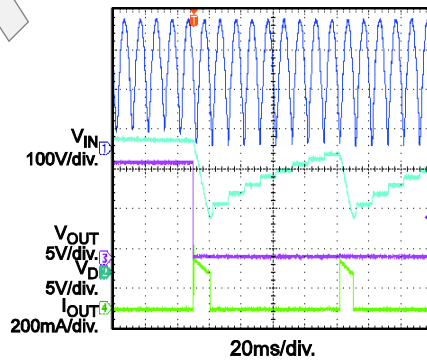
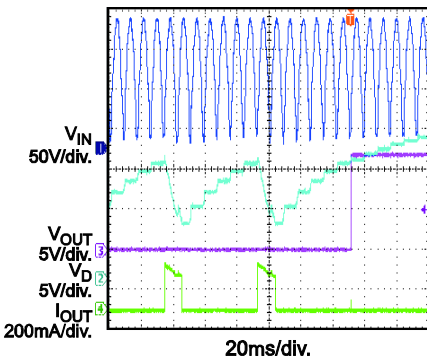
Input Power Start Up
 $V_{IN} = 115Vac, 12V/10mA$

Input Power Start Up
 $V_{IN} = 230Vac, 12V/10mA$

Input Power Shut Down
 $V_{IN} = 115Vac, 12V/10mA$

Input Power Shut Down
 $V_{IN} = 230Vac, 12V/10mA$

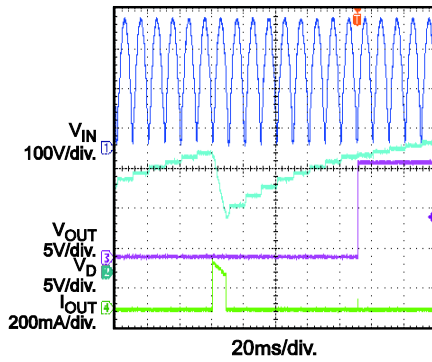
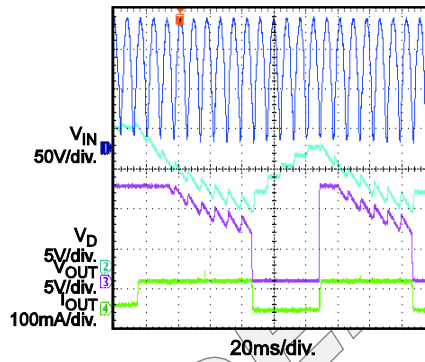
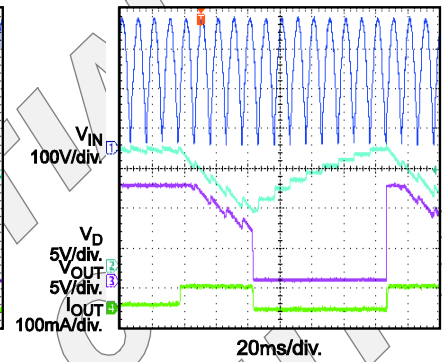
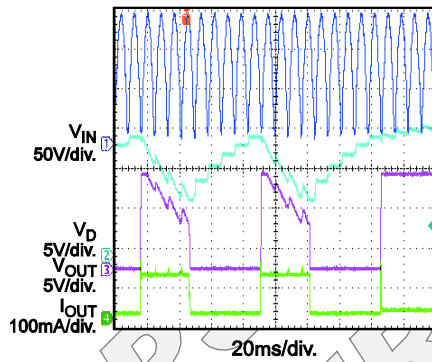
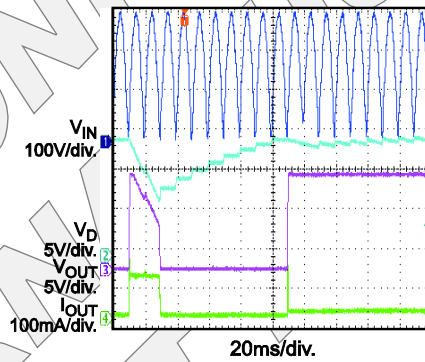
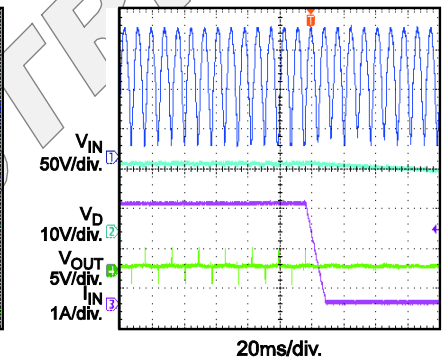
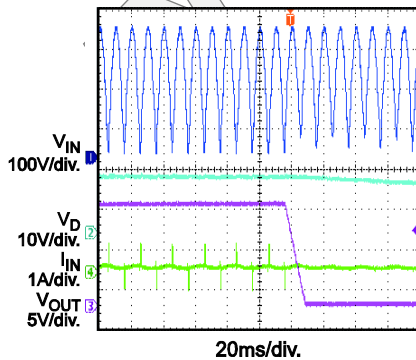
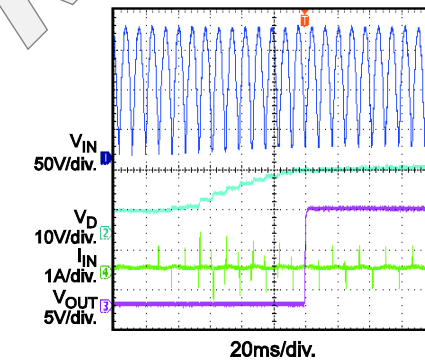
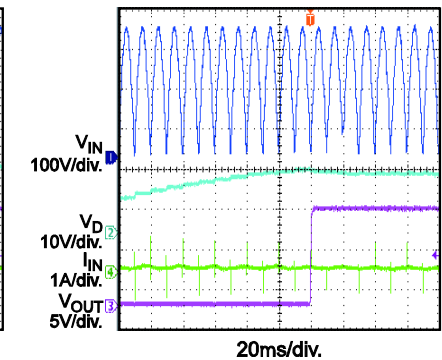
Load Transient
 $V_{IN} = 115Vac, I_{OUT} = 0 \text{ to } 10mA$

Load Transient
 $V_{IN} = 230Vac, I_{OUT} = 0 \text{ to } 10mA$

Short Circuit Protection Entry
 $V_{IN} = 115Vac$

Short Circuit Protection Entry
 $V_{IN} = 230Vac$

Short Circuit Protection Recovery
 $V_{IN} = 115Vac$

EVB TEST RESULTS *(continued)*

Performance waveforms are tested on the evaluation board.

 $V_{OUT} = 12V, I_{OUT} = 10mA, T_A = 23^{\circ}C$, unless otherwise noted.

Short Circuit Protection Recovery
 $V_{IN} = 230Vac$

Over Current Protection Entry
 $V_{IN} = 115Vac$

Over Current Protection Entry
 $V_{IN} = 230Vac$

Over Current Protection Recovery
 $V_{IN} = 115Vac$

Over Current Protection Recovery
 $V_{IN} = 230Vac$

Thermal Shut Down
 $V_{IN} = 115Vac$

Thermal Shut Down
 $V_{IN} = 230Vac$

Thermal Recovery
 $V_{IN} = 115Vac$

Thermal Recovery
 $V_{IN} = 230Vac$

PRINTED CIRCUIT BOARD LAYOUT

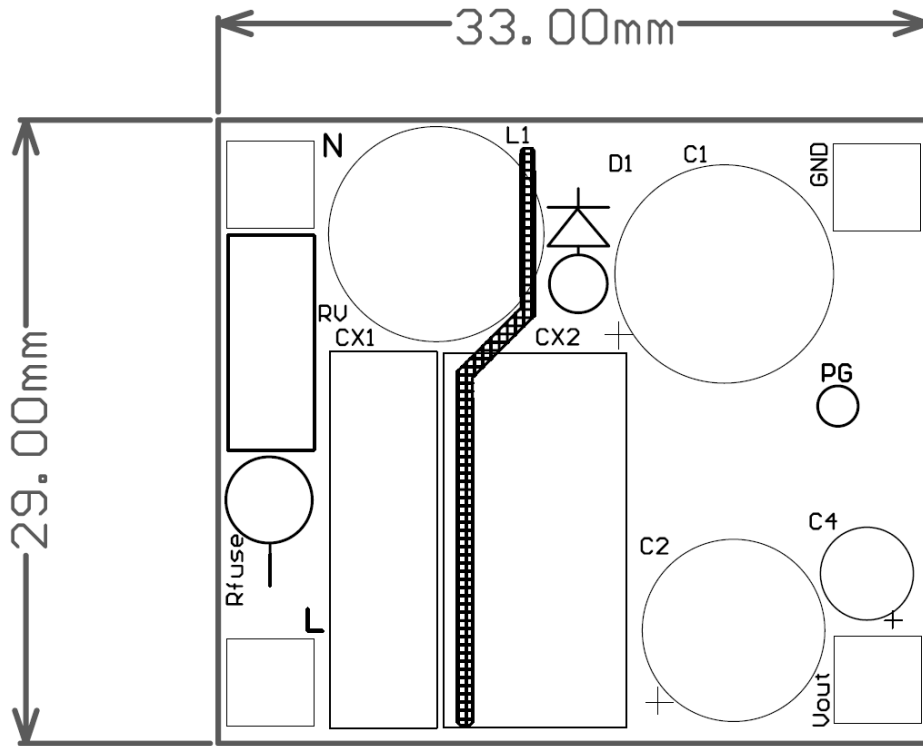

Figure 1 — Top Silk Layer

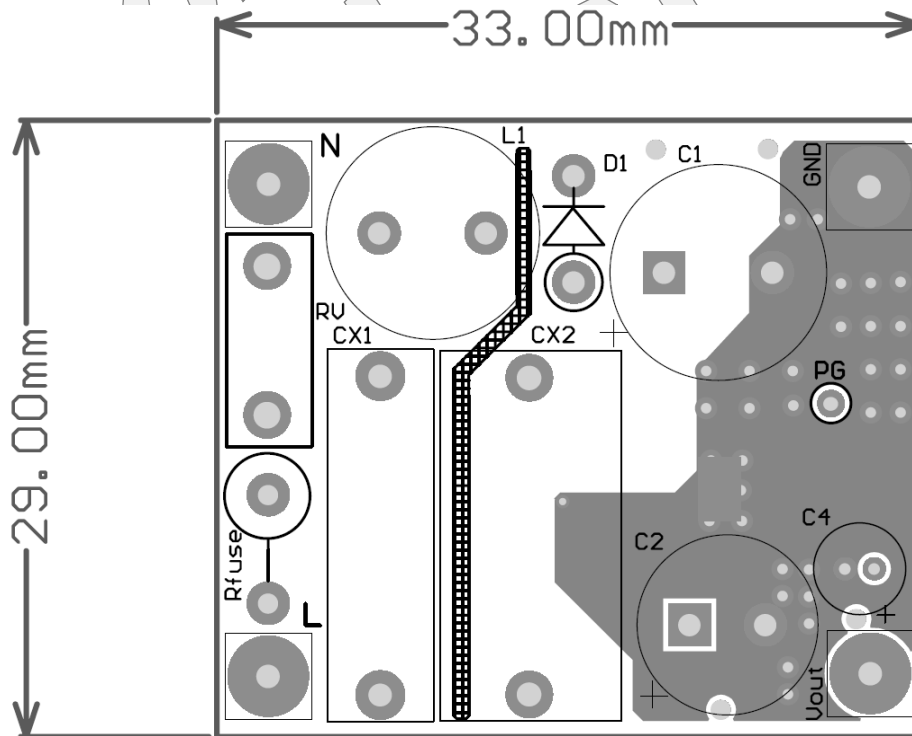

Figure 2 — Top Layer

PRELIMINARY SPECIFICATIONS SUBJECT TO CHANGE

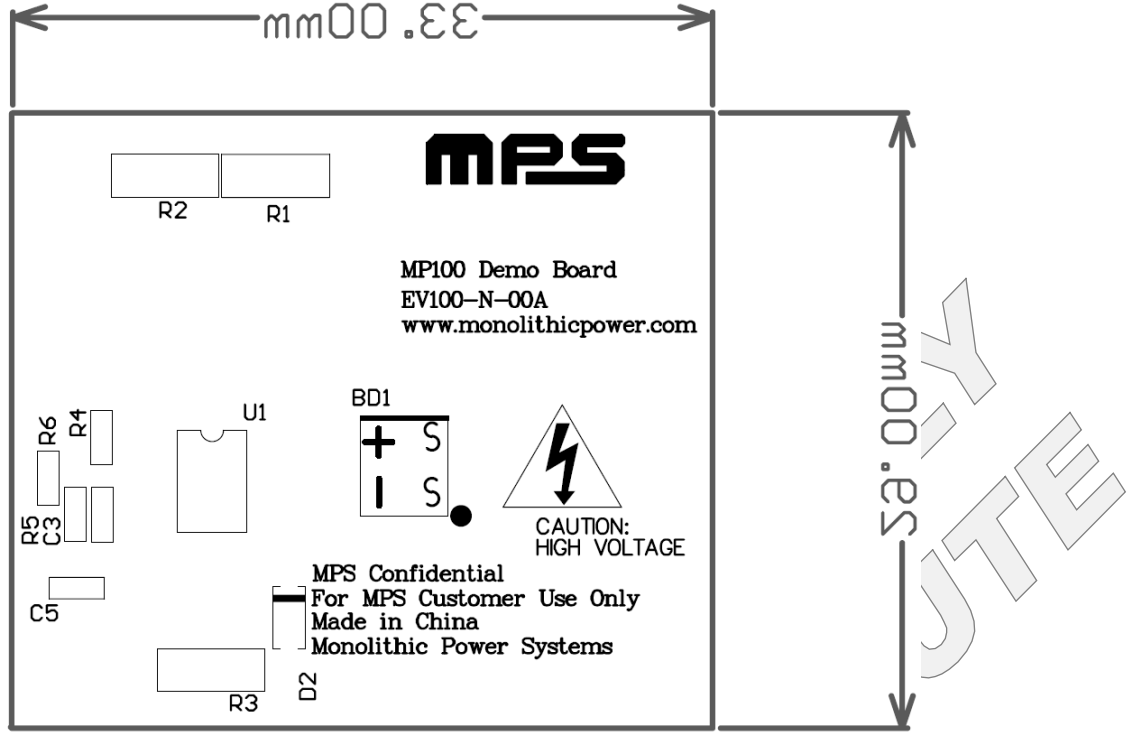

Figure 3 — Bottom Silk

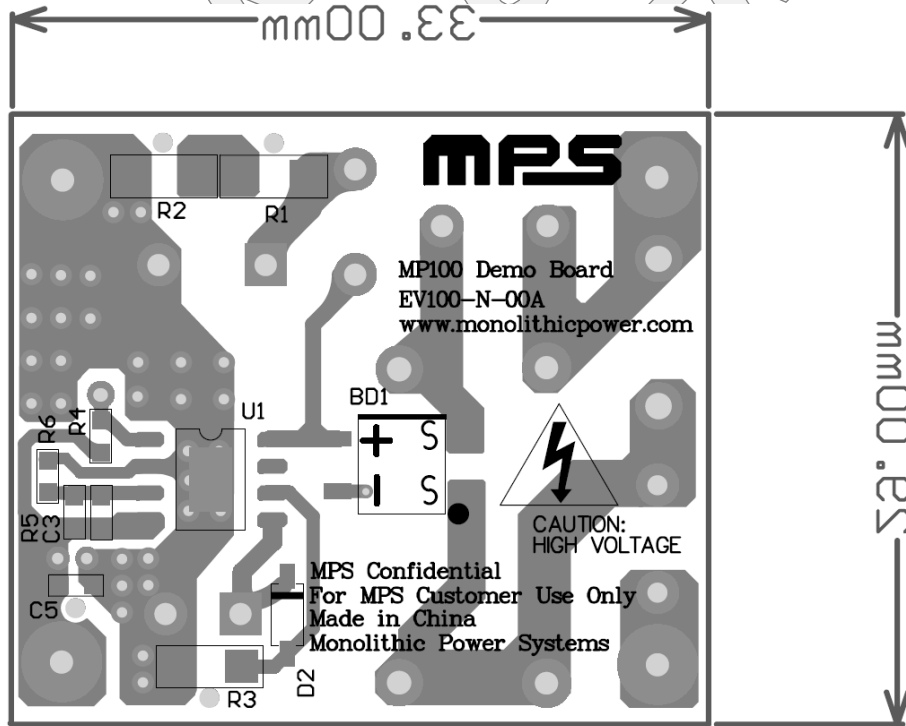

Figure 4 — Bottom Layer

QUICK START GUIDE

1. Preset Power Supply to $85V \leq V_{IN} \leq 265V$.
2. Turn Power Supply off.
3. Connect the Line and Neutral terminals of the power supply output to L and N ports.
4. Connect Load to Vout and GND ports.
5. Turn Power Supply on after making connections.

Contact Information

To request this evaluation board, please refer to your local sales offices which can be found from:

<http://www.monolithicpower.com/Company/Contact-Us>

Disclaimer

Monolithic Power Systems (MPS) reserves the right to make changes to its products and to discontinue products without notice. The applications information, schematic diagrams, and other reference information included herein is provided as a design aid only and are therefore provided as-is. MPS makes no warranties with respect to this information and disclaims any implied warranties of merchantability or non-infringement of third-party intellectual property rights.

MPS cannot assume responsibility for use of any circuitry other than circuitry entirely embodied in a MPS product. No circuit patent licenses are implied.

Certain applications using semiconductor products may involve potential risks of death, personal injury, or severe property or environmental damage (“Critical Applications”).

MPS PRODUCTS ARE NOT DESIGNED, INTENDED, AUTHORIZED, OR WARRANTED TO BE SUITABLE FOR USE IN LIFE-SUPPORT APPLICATIONS, DEVICES OR SYSTEMS, OR OTHER CRITICAL APPLICATIONS.

Inclusion of MPS products in critical applications is understood to be fully at the risk of the customer. Questions concerning potential risk applications should be directed to MPS.

MPS semiconductors are typically used in power supplies in which high voltages are present during operation. High voltage safety precautions should be observed in design and operation to minimize the chance of injury.

NOTICE: The information in this document is subject to change without notice. Please contact MPS for current specifications. Users should warrant and guarantee that third party Intellectual Property rights are not infringed upon when integrating MPS products into any application. MPS will not assume any legal responsibility for any said applications.