



MPQ2179A

5.5V, 3A, 2.4MHz, Synchronous Step-Down Converter with Power Good and Soft Start, AEC-Q100 Qualified

DESCRIPTION

The MPQ2179A is a monolithic, step-down, switch-mode converter with integrated internal power MOSFETs. It can achieve up to 3A of output current (I_{OUT}) across a 2.5V to 5.5V input voltage (V_{IN}) range, with excellent load and line regulation. The output voltage (V_{OUT}) can be regulated to as low as 0.6V.

The MPQ2179A is ideal for a wide range of applications, including automotive clusters, telematics, and infotainment systems.

Constant-on-time (COT) control provides fast transient response and eases loop stabilization.

Full protection features include cycle-by-cycle current limiting, output over-voltage protection (OVP), and thermal shutdown.

The MPQ2179A requires a minimal number of readily available, standard external components, and is available in a compact QFN-8 (1.5mmx2mm) package.

FEATURES

- **Designed for Automotive Applications:**
 - Wide 2.5V to 5.5V Operating Input Voltage (V_{IN}) Range
 - Up to 3A Output Current (I_{OUT})
 - 1% Feedback (FB) Accuracy
 - -40°C to +150°C Operating Junction Temperature (T_J) Range
 - Available in AEC-Q100 Grade 1
- **Increased Battery Life:**
 - 21 μ A Sleep Mode Quiescent Current (I_Q)
 - AAM Mode for Increased Efficiency under Light-Load Conditions
- **High Performance for Improved Thermals:**
 - 65m Ω and 35m Ω Integrated Internal Power MOSFETs
- **Optimized for EMC and EMI:**
 - 2.4MHz Switching Frequency (f_{SW})
 - MeshConnect™ Flip-Chip Package
- **Optimized for Board Size and BOM:**
 - Integrated Internal Power MOSFETs
 - Integrated Compensation Network
 - Available in a Compact QFN-8 (1.5mmx2mm) Package
- **Additional Features:**
 - Enable (EN) for Power Sequencing
 - Power Good (PG)
 - 100% Duty Cycle
 - External Soft Start (SS) Control
 - Output Discharge
 - OVP and SCP with Hiccup Mode
 - Available in a Wettable Flank Package

APPLICATIONS

- Automotive Clusters, Telematics, and Infotainment Systems
- Camera Modules
- Key Fobs
- Industrial Supplies
- Battery-Powered Devices

All MPS parts are lead-free, halogen-free, and adhere to the RoHS directive. For MPS green status, please visit the MPS website under Quality Assurance. "MPS", the MPS logo, and "Simple, Easy Solutions" are trademarks of Monolithic Power Systems, Inc. or its subsidiaries.

TYPICAL APPLICATION

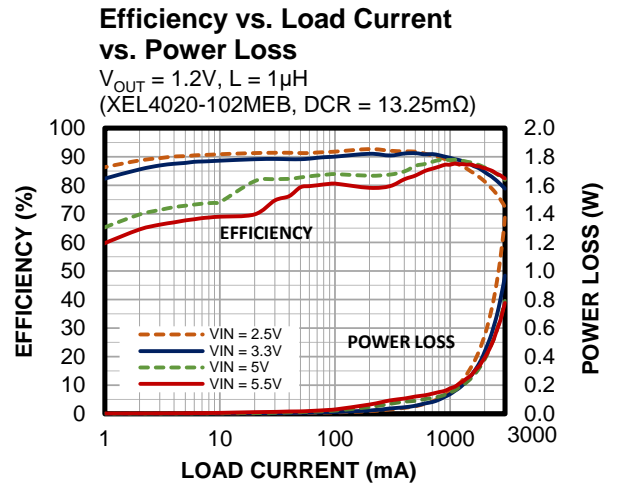
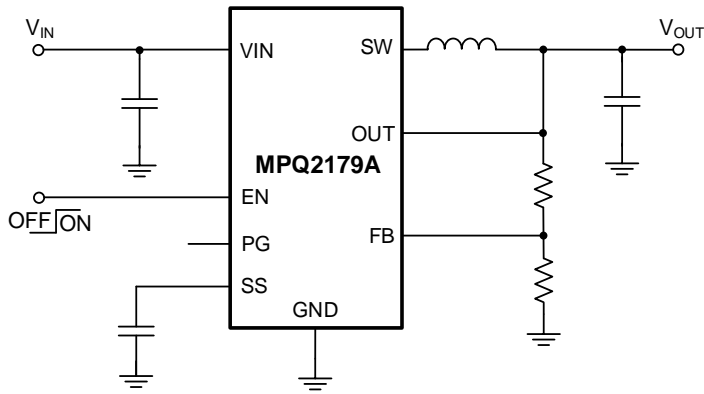

ORDERING INFORMATION

Part Number*	Package	Top Marking	MSL Rating**
MPQ2179AGQHE-AEC1***	QFN-8 (1.5mmx2mm)	See Below	1

* For Tape & Reel, add suffix -Z (e.g. MPQ2179AGQHE-AEC1-Z).

** Moisture Sensitivity Level Rating

*** Wettable Flank

TOP MARKING

—
MC
LL

MC: Product code of the MPQ2179AGQHE-AEC1

LL: Lot number

PACKAGE REFERENCE

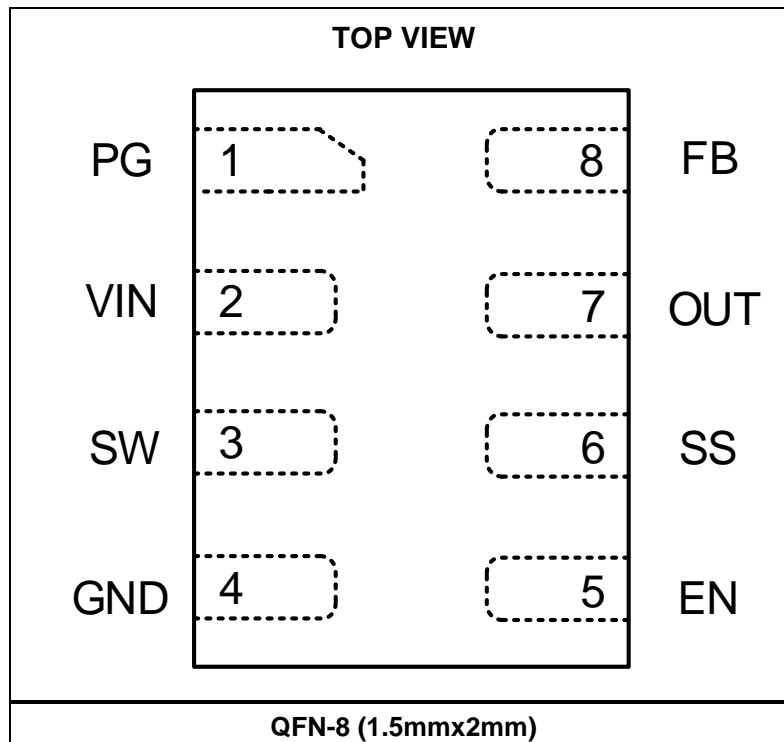

PIN FUNCTIONS

Pin #	Name	Description
1	PG	Power good indicator. The PG pin is an open-drain output. Connect PG to a voltage source via an external resistor. If the feedback (FB) voltage (V_{FB}) exceeds 90% of the reference voltage (V_{REF}), then PG is pulled high. If V_{FB} drops below 85% of V_{REF} , then PG is pulled to GND. Float this pin if not used.
2	VIN	Supply voltage. The MPQ2179A operates from a 2.5V to 5.5V input. A decoupling capacitor is required to prevent large voltage spikes at the input.
3	SW	Output switching node. The SW pin is the drain of the internal P-channel high-side MOSFET (HS-FET). Connect the inductor to SW to complete the converter.
4	GND	Ground.
5	EN	Enable (EN) control. Pull the EN pin above 0.9V to turn the converter on; pull EN below 0.65V or float EN to turn it off. There is an internal 2M Ω resistor connected between EN and GND.
6	SS	Soft start. Connect a capacitor between SS and GND to set the soft-start time (t_{SS}) and to avoid start-up inrush current. The recommended minimum soft-start capacitance (C_{SS}) is 1nF.
7	OUT	Output voltage (V_{OUT}). The OUT pin is V_{OUT} 's power rail and input sense. Connect OUT to the load. An output capacitor (C2) is required to reduce the output voltage ripple (ΔV_{OUT}).
8	FB	Feedback (FB). The FB pin is tapped to an external resistor divider connected between the output and GND. To set the regulation voltage, V_{FB} is compared to the internal V_{REF} (0.6V).

ABSOLUTE MAXIMUM RATINGS ⁽¹⁾

All pins	-0.3V to +6.5V
Junction temperature	150°C
Lead temperature	260°C
Continuous power dissipation ($T_A = 25^\circ\text{C}$) ^{(2) (5)}	2.2W
Storage temperature	-65°C to +150°C

ESD Ratings

Human body model (HBM)	$\pm 2000\text{V}$
Charged device model (CDM)	$\pm 750\text{V}$

Recommended Operating Conditions

Input voltage (V_{IN})	2.5V to 5.5V
Output voltage (V_{OUT})	0.6V to $V_{IN} - 0.5\text{V}$
Operating junction temp (T_J)	-40°C to +150°C

Thermal Resistance

 θ_{JA} θ_{JC}

QFN-8 (1.5mmx2mm)		
JESD51-7 ^{(3) (4)}	130	25
EVQ2179A-LE-00A ⁽⁵⁾	59	14

Notes:

- Exceeding these ratings may damage the device.
- The maximum allowable power dissipation is a function of the maximum junction temperature T_J (MAX), the junction-to-ambient thermal resistance θ_{JA} , and the ambient temperature T_A . The maximum allowable continuous power dissipation at any ambient temperature is calculated by P_D (MAX) = $(T_J$ (MAX) - T_A) / θ_{JA} . Exceeding the maximum allowable power dissipation can cause excessive die temperature, and the device may go into thermal shutdown. Internal thermal shutdown circuitry protects the device from permanent damage.
- Measured on JESD51-7, 4-layer PCB.
- The values given in this table are only valid for comparison with other packages and cannot be used for design purposes. These values were calculated in accordance with JESD51-7, and simulated on a specified JEDEC board. They do not represent the performance obtained in an actual application.
- Measured on the EVQ2179A-LE-00A, a 4-layer, 6.3cmx6.3cm PCB with 2oz per layer.

ELECTRICAL CHARACTERISTICS

$V_{IN} = 3.6V$, $T_J = -40^{\circ}C$ to $+150^{\circ}C$, typical values are tested at $T_J = 25^{\circ}C$, unless otherwise noted.

Parameter	Symbol	Condition	Min	Typ	Max	Units
Input voltage	V_{IN}		2.5		5.5	V
Under-voltage lockout (UVLO) rising threshold	V_{UVLO_RISING}			2.3	2.45	V
UVLO threshold hysteresis	V_{UVLO_HYS}			200		mV
Shutdown current	I_{SD}	$V_{EN} = 0V$, $T_J = 25^{\circ}C$		0.01	1	μA
		$V_{EN} = 0V$, $T_J = -40^{\circ}C$ to $+125^{\circ}C$ ⁽⁶⁾			3	μA
		$V_{EN} = 0V$, $T_J = -40^{\circ}C$ to $+150^{\circ}C$			20	μA
Quiescent current	I_Q	$V_{EN} = 2V$, $V_{FB} = 0.63V$, $V_{IN} = 3.6V$, $T_J = 25^{\circ}C$		21	30	μA
		$V_{EN} = 2V$, $V_{FB} = 0.63V$, $V_{IN} = 3.6V$, $T_J = -40^{\circ}C$ to $+125^{\circ}C$ ⁽⁶⁾			40	μA
		$V_{EN} = 2V$, $V_{FB} = 0.63V$, $V_{IN} = 3.6V$, $T_J = -40^{\circ}C$ to $+150^{\circ}C$			80	μA
Feedback (FB) voltage	V_{FB}	$T_J = 25^{\circ}C$	594	600	606	mV
		$T_J = -40^{\circ}C$ to $+150^{\circ}C$	591	600	609	
FB current	I_{FB}	$V_{FB} = 0.63V$		50	100	nA
P-channel high-side MOSFET (HS-FET) on resistance	$R_{DS(ON)_HS}$	$V_{IN} = 5V$		65	85	m Ω
N-channel low-side MOSFET (LS-FET) on resistance	$R_{DS(ON)_LS}$	$V_{IN} = 5V$		35	55	m Ω
Zero-current detection (ZCD) threshold				50		mA
Switch leakage current		$V_{EN} = 0V$, $V_{IN} = 6V$, $V_{SW} = 0V$ or $6V$, $T_J = 25^{\circ}C$		0	1	μA
		$V_{EN} = 0V$, $V_{IN} = 6V$, $V_{SW} = 0V$ or $6V$, $T_J = -40^{\circ}C$ to $+125^{\circ}C$ ⁽⁶⁾			30	μA
Switching frequency	f_{SW}	$V_{IN} = 5V$, $V_{OUT} = 1.2V$, CCM	2000	2400	2640	kHz
Minimum on time ⁽⁶⁾	t_{ON_MIN}	$V_{IN} = 5V$		50		ns
Minimum off time ⁽⁶⁾	t_{OFF_MIN}	$V_{IN} = 5V$		80		ns
P-channel HS-FET peak current limit	I_{LIMIT_PEAK}		4	5	6	A
N-channel LS-FET valley current limit	I_{LIMIT_VALLEY}		1.5	3	4.5	A
Soft-start current	I_{SS}		1.5	3	4.5	μA
Maximum duty cycle				100		% V_{FB}
Power good (PG) UVLO rising threshold	$V_{PG_UVLO_RISING}$	FB rising edge	87	90	93	% V_{FB}
PG UVLO falling threshold	$V_{PG_UVLO_FALLING}$	FB falling edge	82	85	88	% V_{FB}
PG delay	t_{DELAY_PG}	PG rising/falling edge		80		ms
PG sink current capability	V_{PG_LOW}	1mA sink current			0.4	V
PG logic high voltage	V_{PG_HIGH}	$V_{IN} = 5V$, $V_{FB} = 0.6V$	4.9			V
Self-biased PG		$V_{IN} = 0V$, $V_{EN} = 0V$, PG is pulled up between 3V and 5.5V via a 100k Ω resistor			0.7	V
PG leakage current and logic high		5V logic high			100	nA
Enable (EN) start-up delay		EN on to activate SW		100		μs
EN shutdown delay		EN off to stop switching		30		μs
EN input logic low voltage			0.4	0.65		V

ELECTRICAL CHARACTERISTICS (continued)
 $V_{IN} = 3.6V$, $T_J = -40^{\circ}C$ to $+150^{\circ}C$, typical values are tested at $T_J = 25^{\circ}C$, unless otherwise noted.

Parameter	Symbol	Condition	Min	Typ	Max	Units
EN input logic high voltage				0.9	1.2	V
EN pull-down resistor				2		M Ω
Output discharge resistor	R _{DISCHARGE}	$V_{EN} = 0V$, $V_{OUT} = 1.2V$		150		Ω
EN input current		$V_{EN} = 2V$		1.2		μA
		$V_{EN} = 0V$		0		μA
Output over-voltage protection (OVP) rising threshold	V _{OVP_RISING}		110	115	120	% V_{FB}
Output OVP hysteresis	V _{OVP_HYS}			10		% V_{FB}
Output over-voltage delay				2		μs
Low-side MOSFET (LS-FET) current limit		Current flows from SW to GND		1.2		A
Absolute V_{IN} over-voltage protection (OVP)		After V_{OUT} OVP is enabled		6.1		V
Absolute V_{IN} OVP hysteresis				160		mV
Thermal shutdown ⁽⁶⁾				170		$^{\circ}C$
Thermal shutdown hysteresis ⁽⁶⁾				20		$^{\circ}C$

Note:

6) Guaranteed by design and bench characterization. Not tested in production.

TYPICAL CHARACTERISTICS

$V_{IN} = 3.6V$, $T_J = -40^{\circ}C$ to $+150^{\circ}C$, unless otherwise noted.

V_{IN} UVLO Threshold vs. Temperature

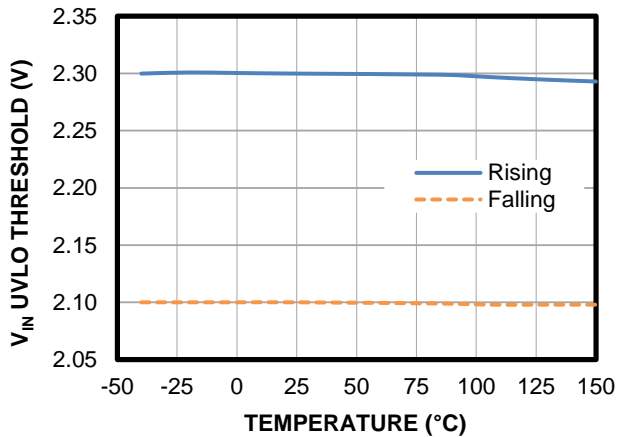

EN Threshold vs. Temperature

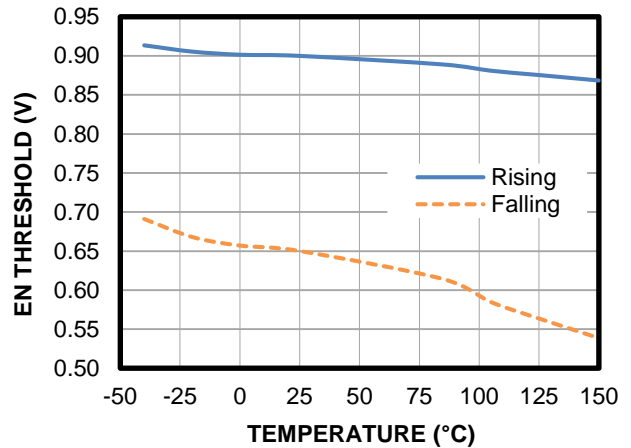

Shutdown Current vs. Temperature

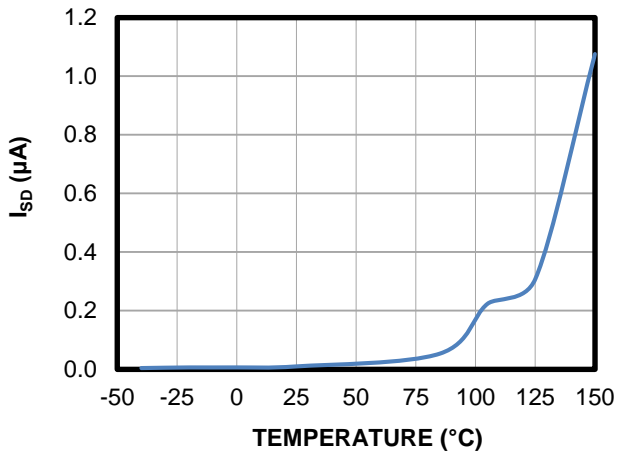

Quiescent Current vs. Temperature

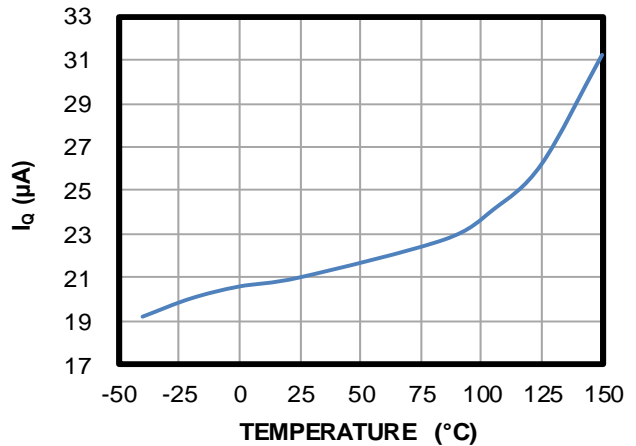

Feedback Voltage vs. Temperature

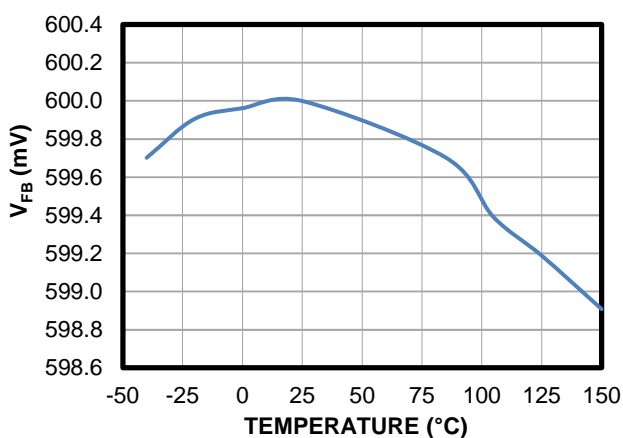

Switching Frequency vs. Temperature

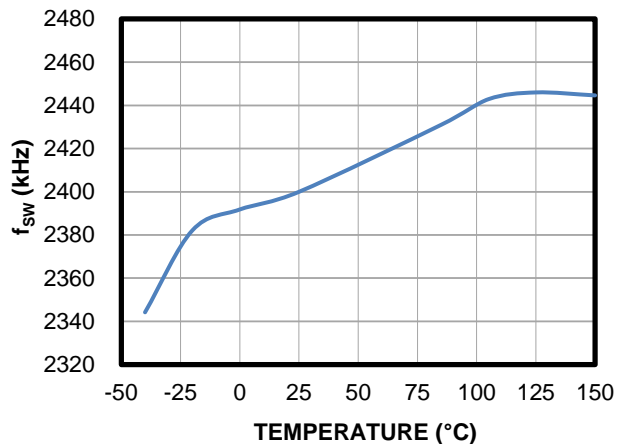

TYPICAL CHARACTERISTICS (continued)
 $V_{IN} = 3.6V$, $T_J = -40^{\circ}C$ to $+150^{\circ}C$, unless otherwise noted.

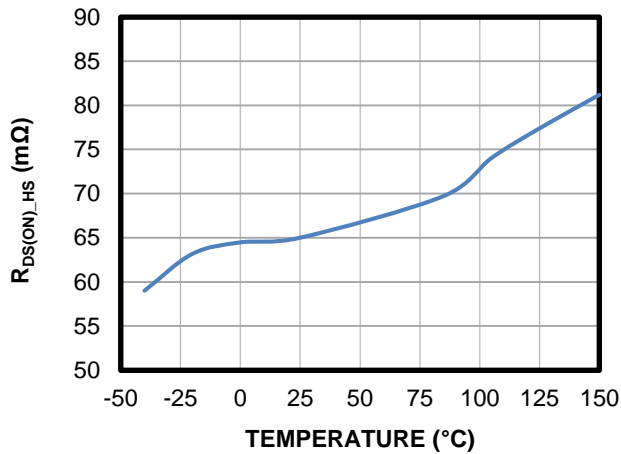
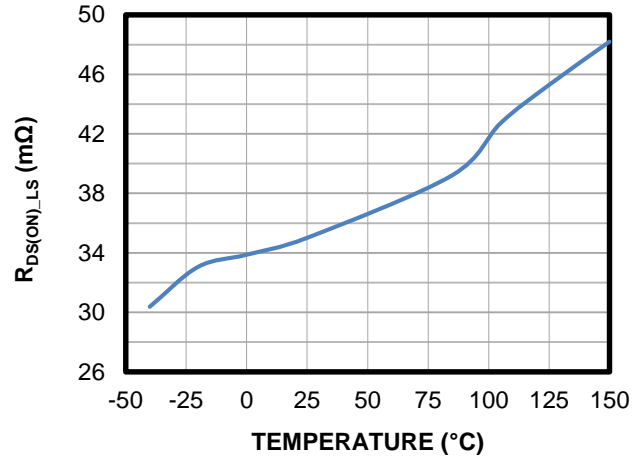
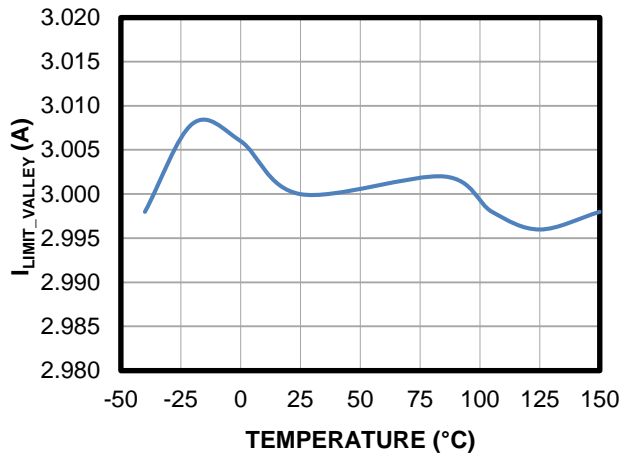
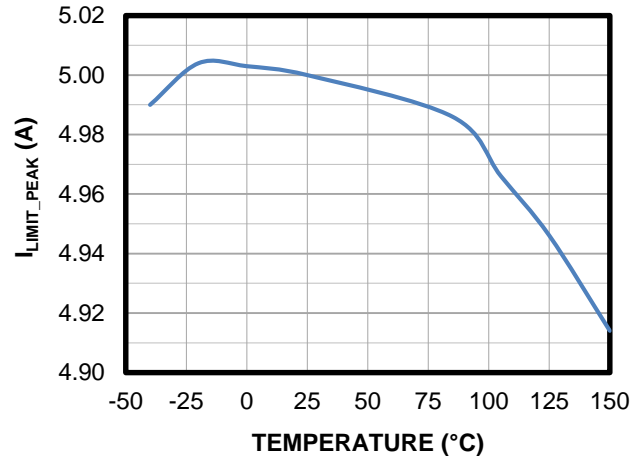
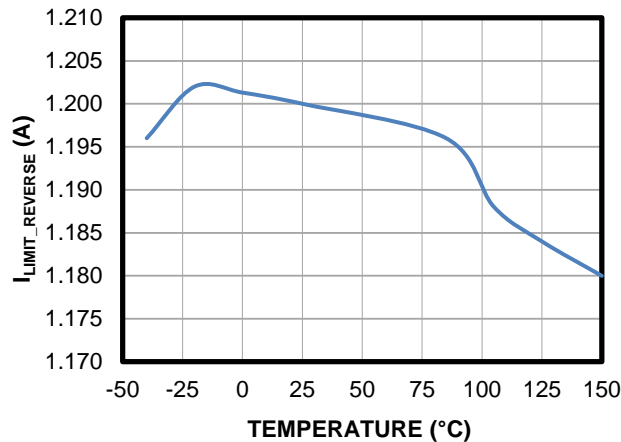
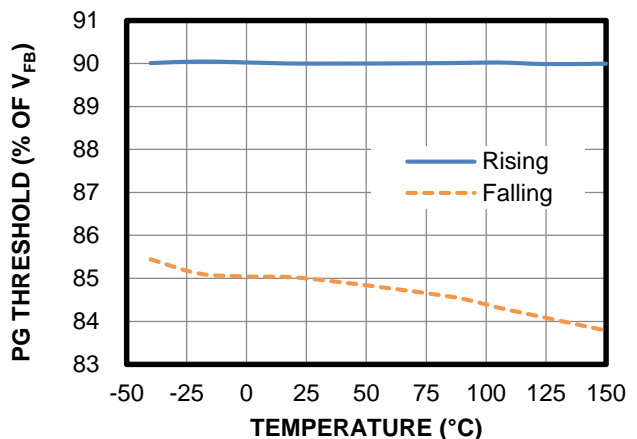
 $R_{DS(ON)_HS}$ vs. Temperature

 $R_{DS(ON)_LS}$ vs. Temperature

LS-FET Valley Current Limit vs. Temperature

HS-FET Peak Current Limit vs. Temperature

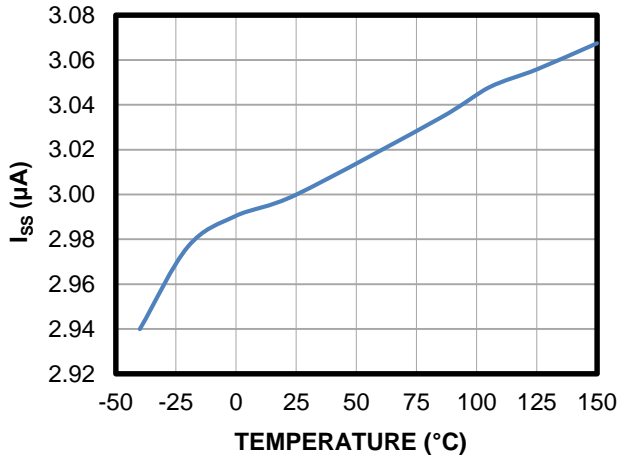
LS-FET Reverse Current Limit vs. Temperature

PG Threshold vs. Temperature

TYPICAL CHARACTERISTICS (continued)

$V_{IN} = 3.6V$, $T_J = -40^{\circ}C$ to $+150^{\circ}C$, unless otherwise noted.

Soft-Start Current vs. Temperature



Zero-Current Detection vs. Temperature

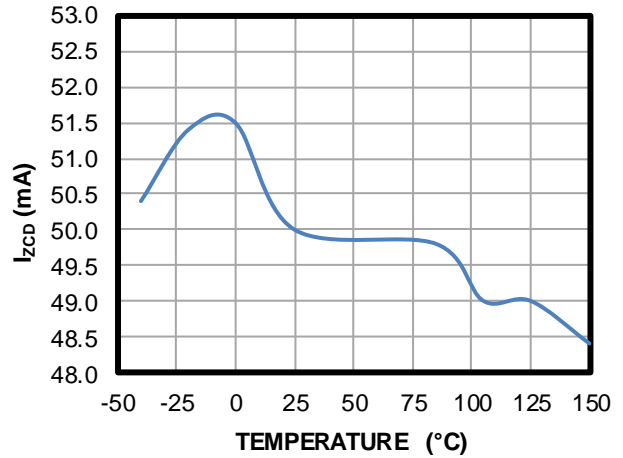

TYPICAL PERFORMANCE CHARACTERISTICS

$V_{IN} = 3.3V$, $V_{OUT} = 1.2V$, $L = 1\mu H$, $C2 = 22\mu F$, $T_A = 25^\circ C$, unless otherwise noted.

Efficiency vs. Load Current

$V_{OUT} = 1.2V$, $L = 1\mu H$
(XEL4020-102MEB, DCR = 13.25m Ω)

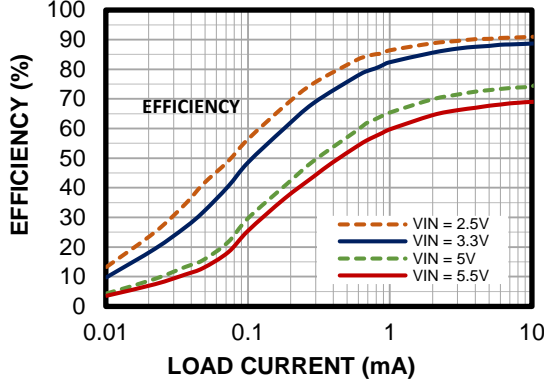

Efficiency vs. Load Current vs. Power Loss

$V_{OUT} = 1.2V$, $L = 1\mu H$
(XEL4020-102MEB, DCR = 13.25m Ω)

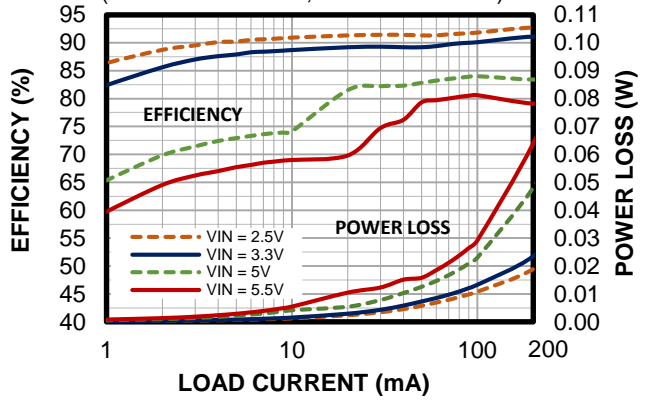

Efficiency vs. Load Current vs. Power Loss

$V_{OUT} = 1.2V$, $L = 1\mu H$
(XEL4020-102MEB, DCR = 13.25m Ω)

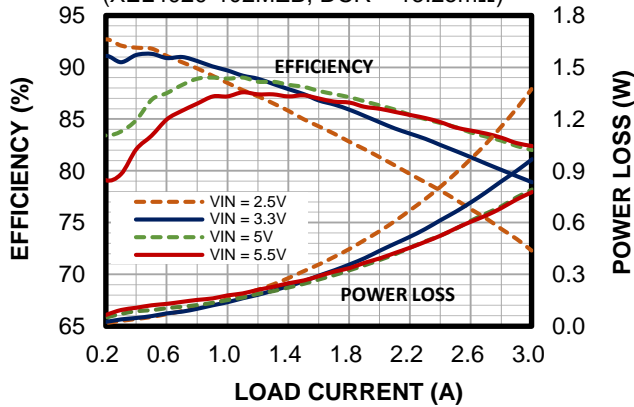

Efficiency vs. Load Current

$V_{OUT} = 1.8V$, $L = 1\mu H$
(XEL4020-102MEB, DCR = 13.25m Ω)

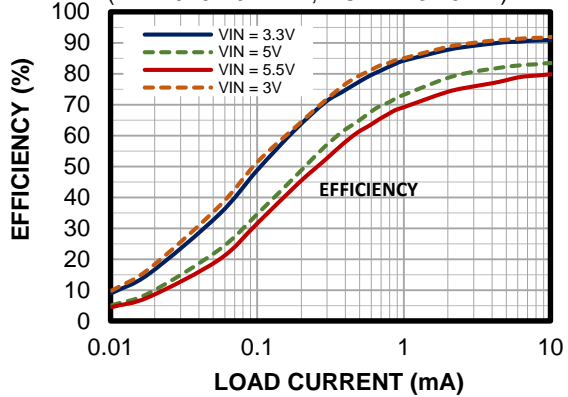

Efficiency vs. Load Current vs. Power Loss

$V_{OUT} = 1.8V$, $L = 1\mu H$
(XEL4020-102MEB, DCR = 13.25m Ω)

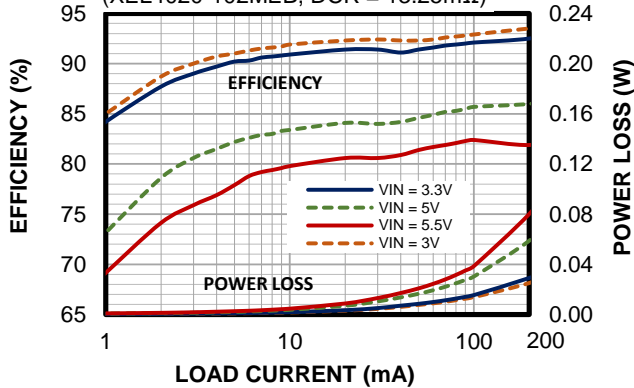

Efficiency vs. Load Current vs. Power Loss

$V_{OUT} = 1.8V$, $L = 1\mu H$
(XEL4020-102MEB, DCR = 13.25m Ω)

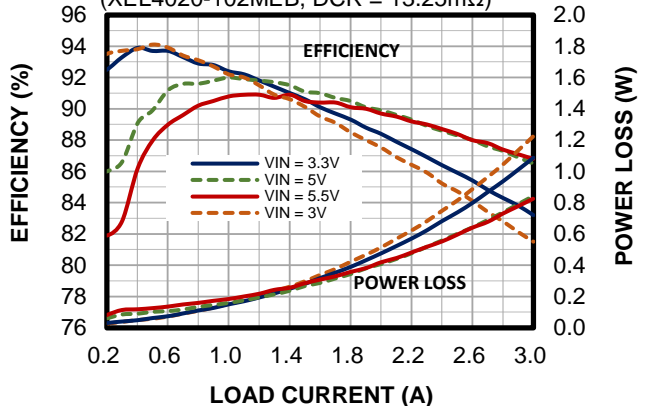

TYPICAL PERFORMANCE CHARACTERISTICS (continued)

$V_{IN} = 3.3V$, $V_{OUT} = 1.2V$, $L = 1\mu H$, $C2 = 22\mu F$, $T_A = 25^\circ C$, unless otherwise noted.

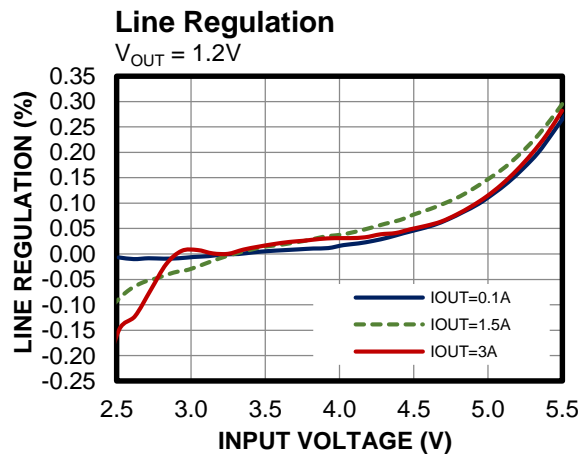
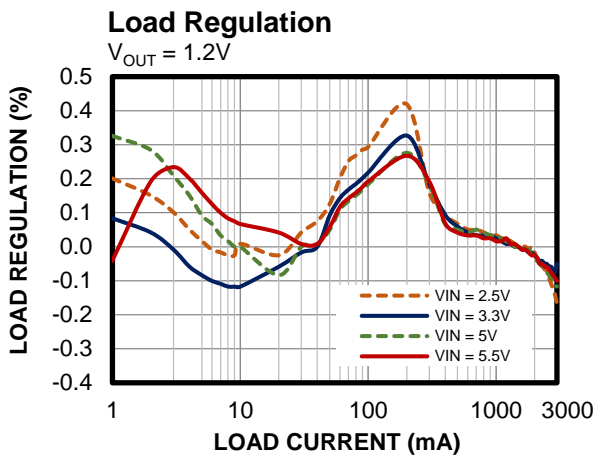
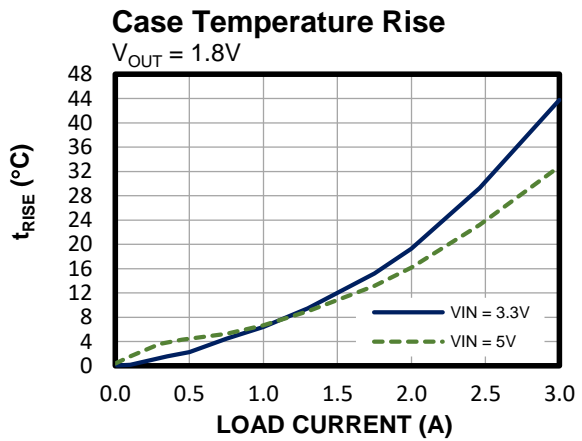
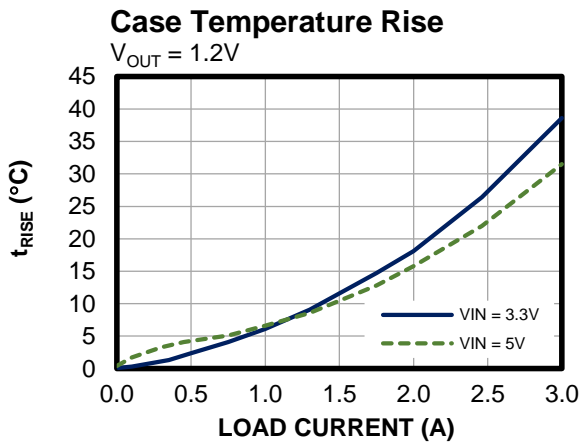

TYPICAL PERFORMANCE CHARACTERISTICS (continued)
 $V_{IN} = 3.3V$, $V_{OUT} = 1.2V$, $L = 1\mu H$, $C2 = 22\mu F$, $T_A = 25^\circ C$, unless otherwise noted.

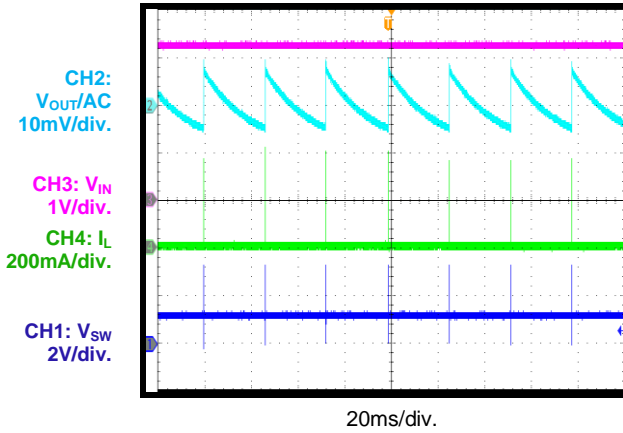
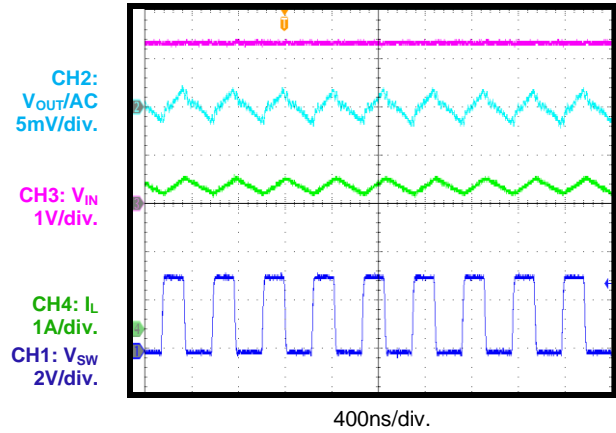
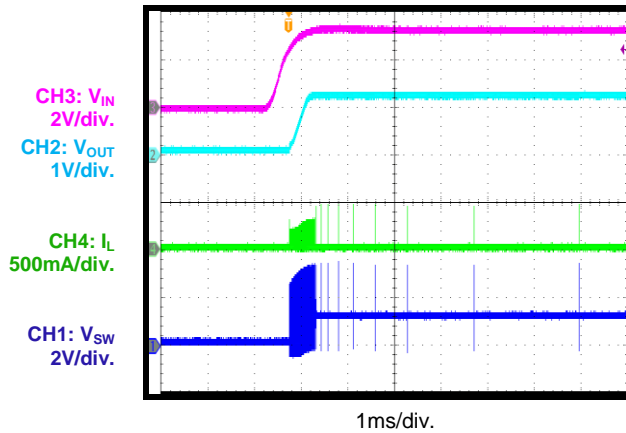
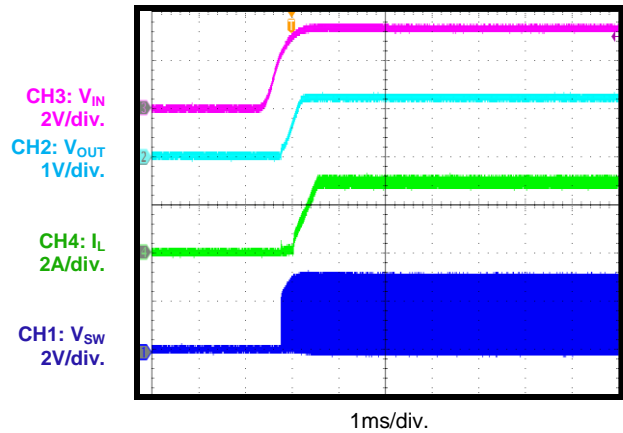
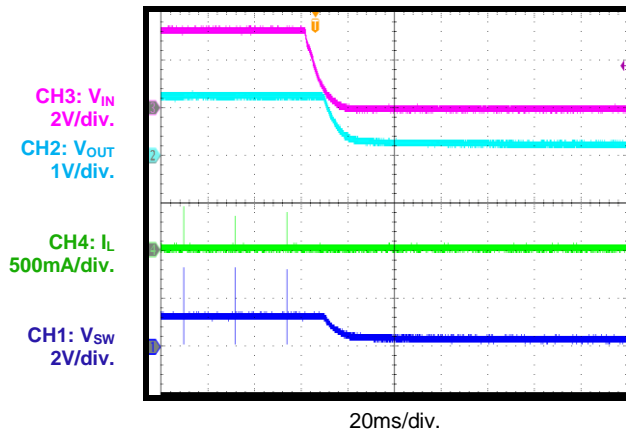
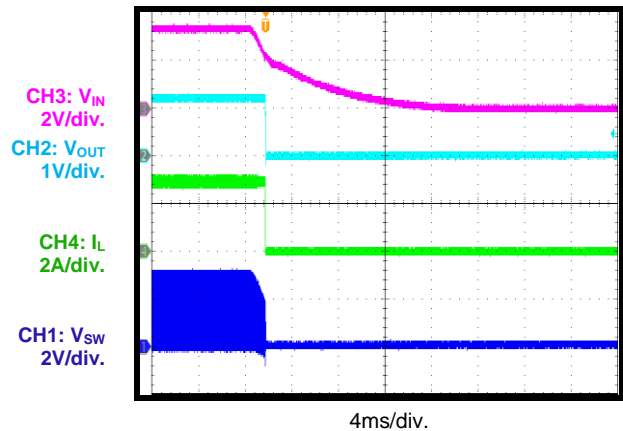
Steady State
 $I_{OUT} = 0A$

Steady State
 $I_{OUT} = 3A$

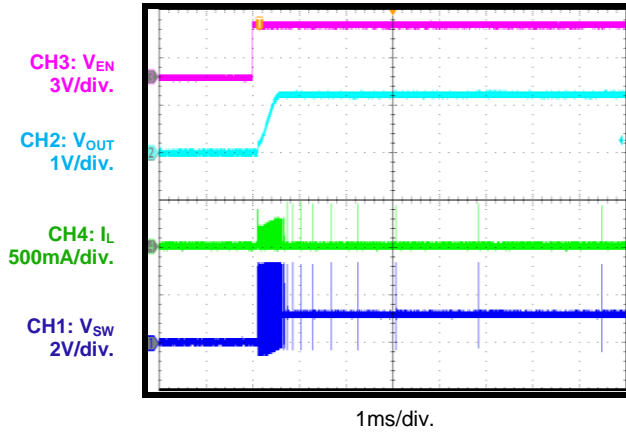
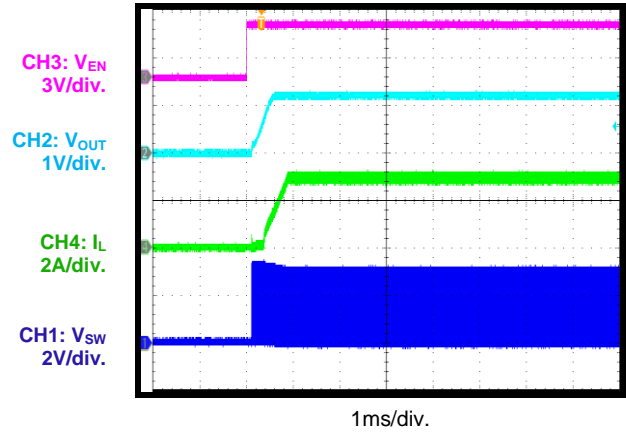
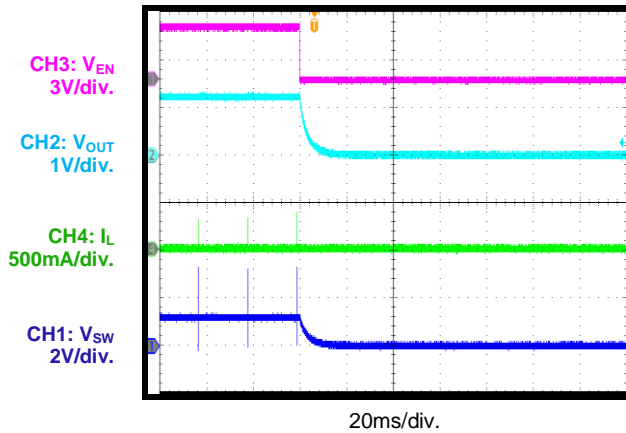
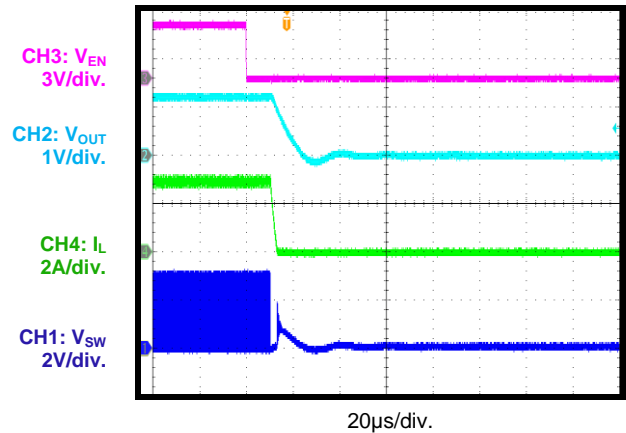
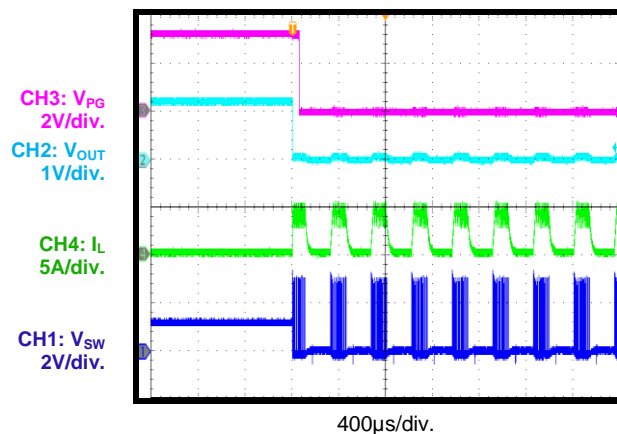
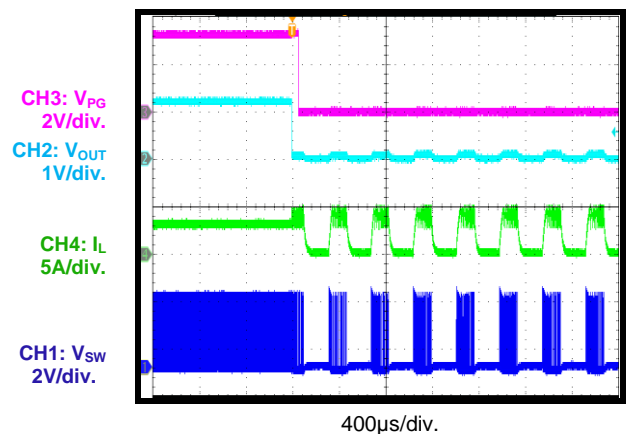
Start-Up through VIN
 $I_{OUT} = 0A$

Start-Up through VIN
 $I_{OUT} = 3A$

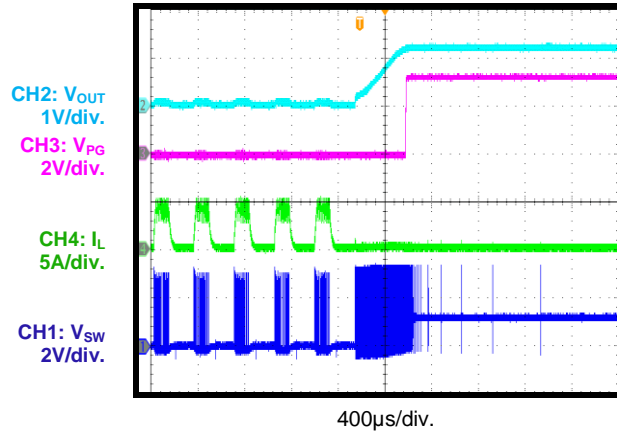
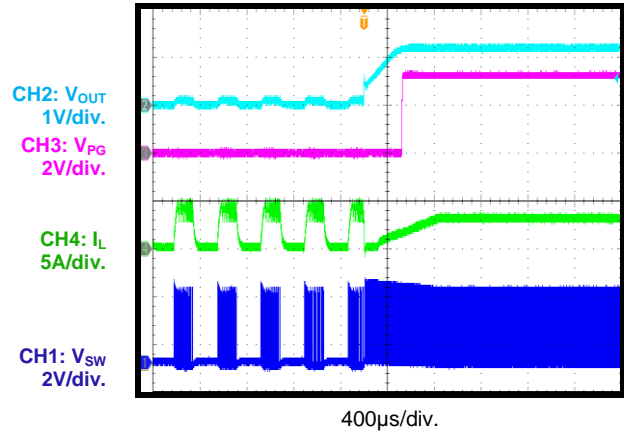
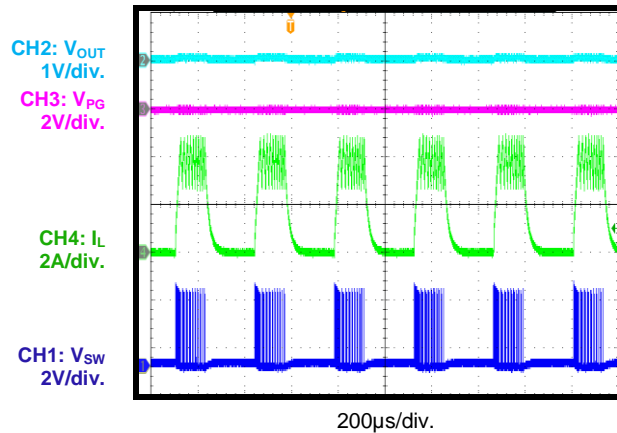
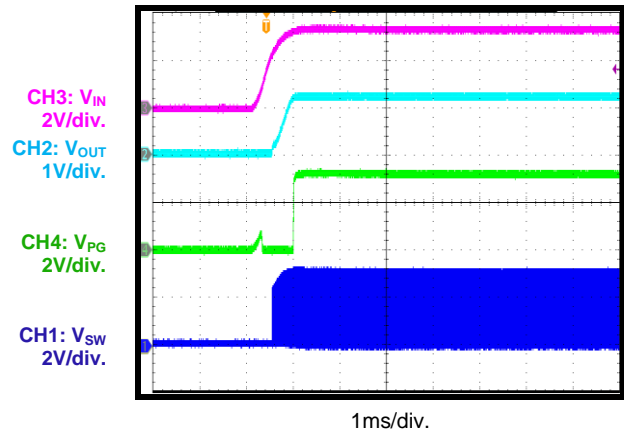
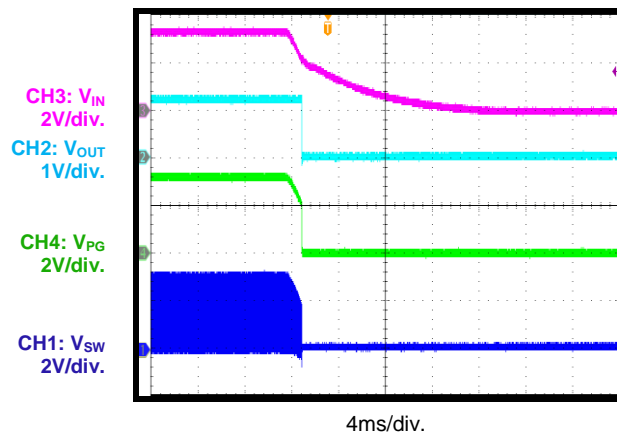
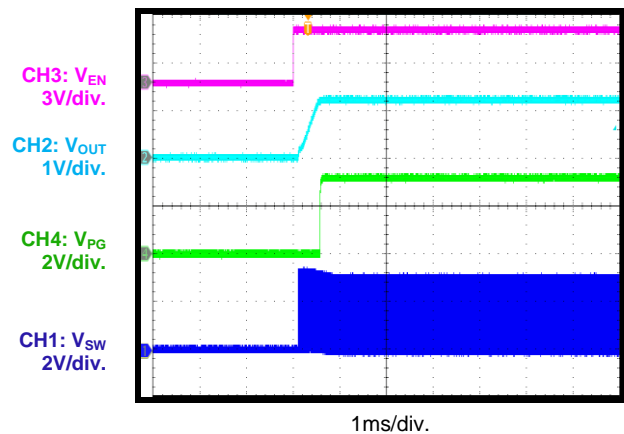
Shutdown through VIN
 $I_{OUT} = 0A$

Shutdown through VIN
 $I_{OUT} = 3A$

TYPICAL PERFORMANCE CHARACTERISTICS (continued)
 $V_{IN} = 3.3V$, $V_{OUT} = 1.2V$, $L = 1\mu H$, $C2 = 22\mu F$, $T_A = 25^\circ C$, unless otherwise noted.

Start-Up through EN
 $I_{OUT} = 0A$

Start-Up through EN
 $I_{OUT} = 3A$

Shutdown through EN
 $I_{OUT} = 0A$

Shutdown through EN
 $I_{OUT} = 3A$

SCP Entry
 $I_{OUT} = 0A$

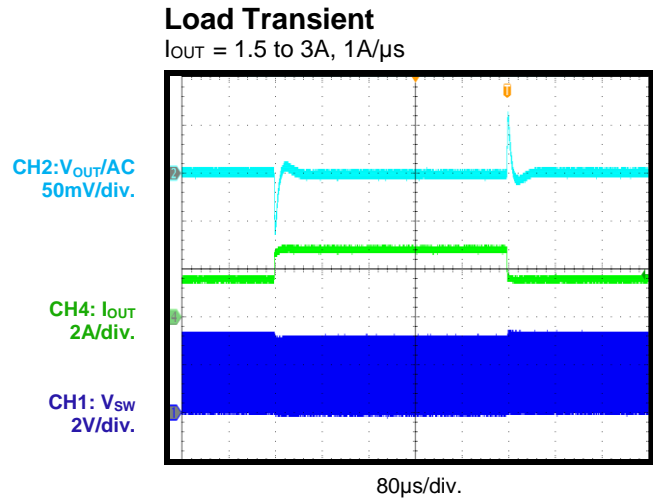
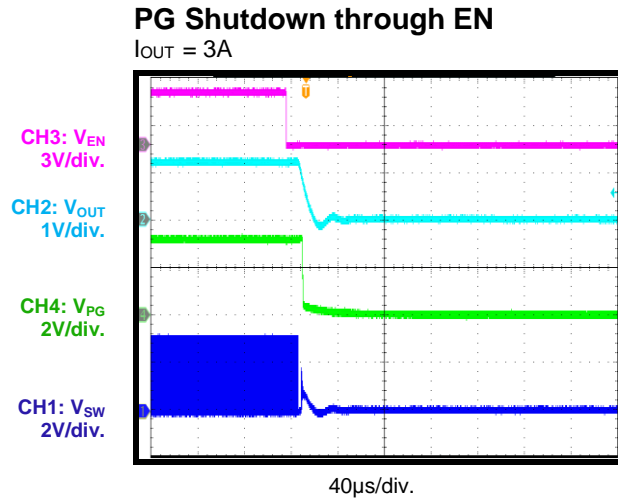
SCP Entry
 $I_{OUT} = 3A$

TYPICAL PERFORMANCE CHARACTERISTICS (continued)
 $V_{IN} = 3.3V$, $V_{OUT} = 1.2V$, $L = 1\mu H$, $C2 = 22\mu F$, $T_A = 25^\circ C$, unless otherwise noted.

SCP Recovery
 $I_{OUT} = 0A$

SCP Recovery
 $I_{OUT} = 3A$

Short Circuit Protection

PG Start-Up through VIN
 $I_{OUT} = 3A$

PG Shutdown through VIN
 $I_{OUT} = 3A$

PG Start-Up through EN
 $I_{OUT} = 3A$

TYPICAL PERFORMANCE CHARACTERISTICS *(continued)*

$V_{IN} = 3.3V$, $V_{OUT} = 1.2V$, $L = 1\mu H$, $C2 = 22\mu F$, $T_A = 25^\circ C$, unless otherwise noted.



FUNCTIONAL BLOCK DIAGRAM

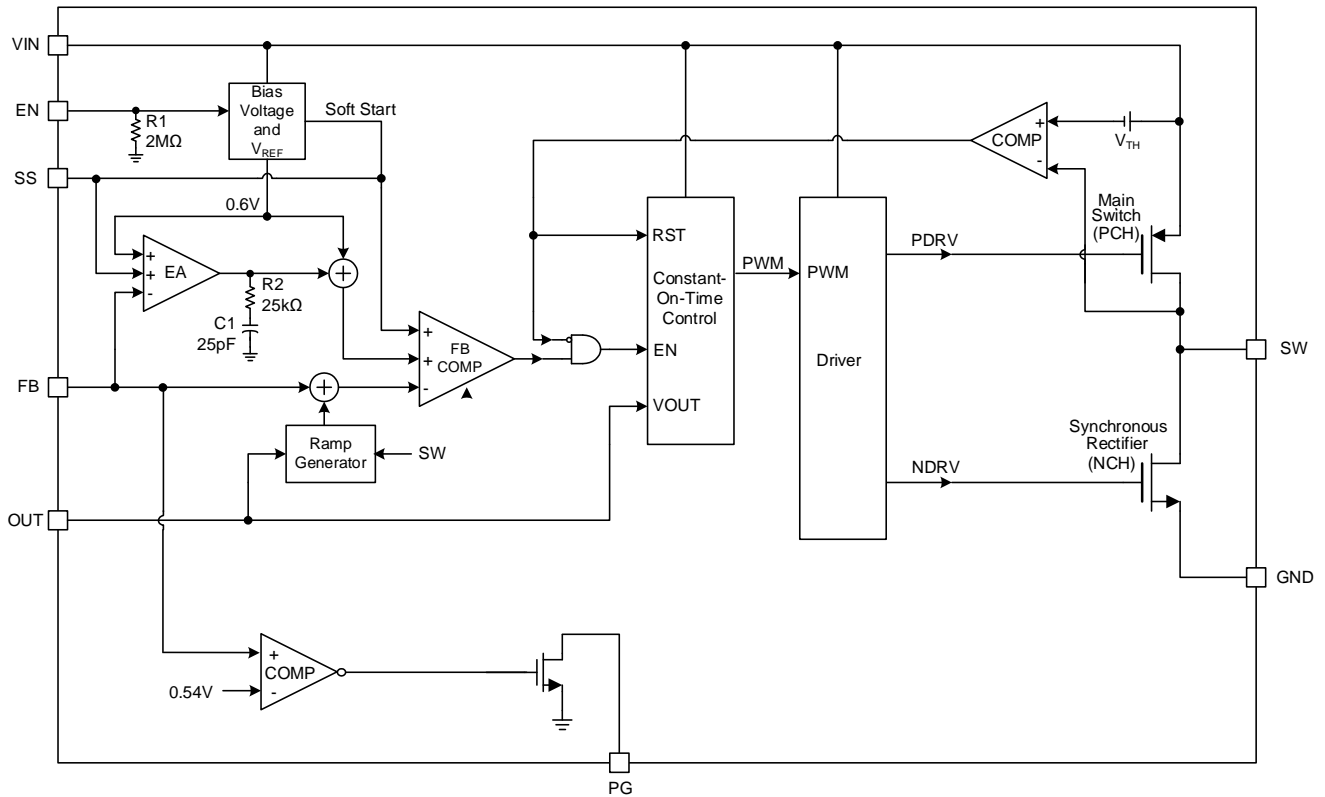

Figure 1: Functional Block Diagram

OPERATION

The MPQ2179A employs input voltage (V_{IN}) feed-forward and constant-on-time (COT) control to stabilize the switching frequency (f_{SW}) across the entire V_{IN} range. It can achieve 3A of output current (I_{OUT}) across a 2.5V to 5.5V V_{IN} range, with excellent load and line regulation. The output voltage (V_{OUT}) can be regulated to as low as 0.6V. A 100% maximum duty cycle can be reached in low-dropout mode.

Constant-On-Time (COT) Control

COT control provides a simpler control loop and faster transient response. The MPQ2179A's switching cycles have a fixed minimum off time (t_{OFF_MIN}) to prevent inductor current (I_L) runaway during load transient. If the low-side MOSFET (LS-FET) turns on remains on for at least t_{MIN_OFF} (typically 80ns). The high-side MOSFET (HS-FET) turns on once the feedback (FB) voltage (V_{FB}) drops below the reference voltage (V_{REF}). This indicates an insufficient V_{OUT} . Input voltage feed-forward allows the device to maintain a nearly constant f_{SW} across the input range and load range. The f_{SW} on time (t_{ON}) can be calculated with Equation (1):

$$t_{ON} = \frac{V_{OUT}}{V_{IN}} \times 400ns \quad (1)$$

Sleep Mode

The MPQ2179A employs sleep mode for high efficiency under light-load conditions. In sleep mode, most of the circuit block input currents (I_{IN}) decrease, specifically the error amplifier (EA) and pulse-width modulation (PWM) comparator.

As the load becomes lighter, the converter's f_{SW} decreases. If the load continues to decrease and the off time (t_{OFF}) exceeds $3.5\mu s$, then the MPQ2179A enters sleep mode. To further improve light-load efficiency, the converter consumes a very low quiescent current (I_Q) while in sleep mode.

Once an HS-FET pulse occurs, the MPQ2179A exits sleep mode.

Advanced Asynchronous Modulation (AAM) Mode under Light-Load Conditions

The device features advanced asynchronous modulation (AAM) mode and a zero-current detection (ZCD) circuit for light-load operation.

The AAM current (I_{AAM}) is set internally. The SW pin's on time (t_{ON}) is determined by the on-timer generator and AAM comparator. Under light-load conditions, SW's t_{ON} exceeds the AAM comparator's t_{ON} . Figure 2 shows the simplified AAM control logic.

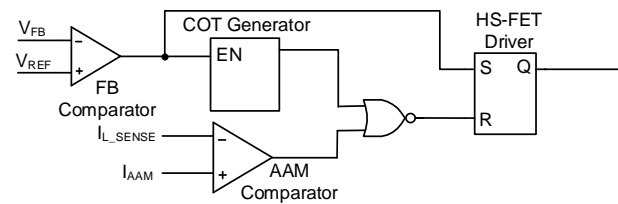

Figure 2: Simplified AAM Control Logic

If the AAM comparator's t_{ON} exceeds the on-timer's pulse, then the AAM comparator controls SW's t_{ON} (see Figure 3).

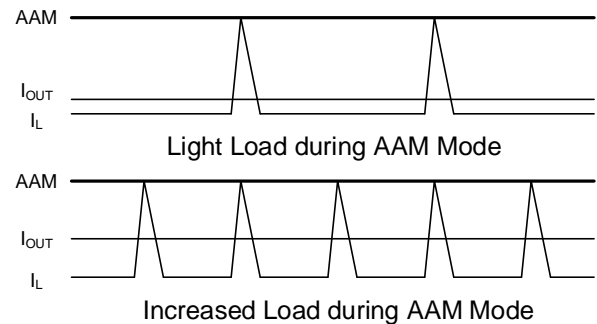

Figure 3: AAM Comparator Controls SW's t_{ON}

When using a lower-value inductor, the AAM comparator's t_{ON} is below the on-timer, the operation mode is below in Figure 4. The HS-FET depends on the on-timer, therefore the on-timer controls t_{ON} (see Figure 4).

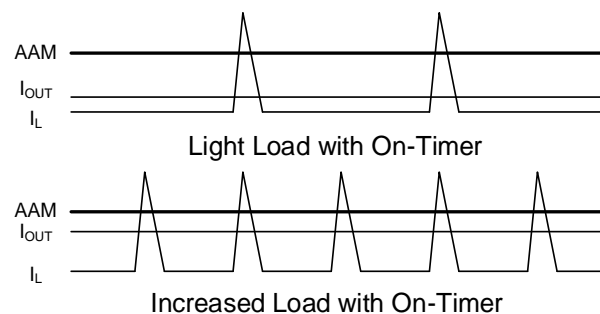

Figure 4: On-Timer Controls SW's t_{ON}

Aside from the on-timer method, the AAM circuit has another AAM blanking time (150ns) for sleep mode. This means that if the on-timer drops below 150ns, then the HS-FET turns off after an on-timer pulse is generated without AAM control. In this scenario, I_L may not reach the AAM threshold (see Figure 5).

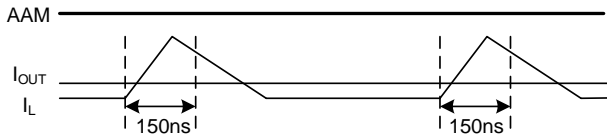

Figure 5: AAM Blanking Time during Sleep Mode

In sleep mode, the on-timer’s pulse is about 40% greater than its pulse during discontinuous conduction mode (DCM) and continuous conduction mode (CCM). Figure 6 shows how the AAM threshold decreases as t_{ON} increases gradually. For CCM, I_{OUT} must exceed half of the AAM threshold.

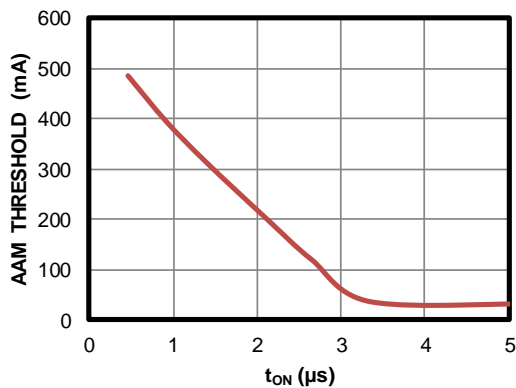

Figure 6: AAM Threshold Decreases as t_{ON} Increases

The MPQ2179A employs ZCD to determine whether I_L begins to reverse. If I_L reaches the ZCD threshold (typically 50mA), then the LS-FET turns off.

Even if V_{OUT} is close to V_{IN} , AAM mode and ZCD allow the device to operate continually in DCM under light-load conditions.

Enable (EN) Control

The enable (EN) pin is a digital control pin that turns the MPQ2179A on and off. Pull EN above 0.9V to turn the converter on; pull EN below 0.65V or float EN to turn it off. Pulling EN to GND also disables the device. There is an internal 2M Ω resistor connected between EN and GND.

Output Discharge

If the MPQ2179A shuts down, the device initiates output discharge mode. The internal discharge MOSFET provides a resistive discharge path for the output capacitor (C2) between the OUT pin and GND. To block the output discharge path, add an external capacitor between V_{OUT} and the OUT pin (see the Output Discharge Blocking section on page 21).

Soft Start (SS)

The MPQ2179A features external soft start (SS). To avoid overshoot during start-up, the SS pin ramps up V_{OUT} at a controlled slew rate. The SS pin’s charge current is typically 3 μA . The soft-start time (t_{SS}) is determined by the external soft-start capacitor (C_{SS}). t_{SS} can be calculated with Equation (2):

$$t_{SS}(\text{ms}) = \frac{C_{SS}(\text{nF}) \times 0.6\text{V}}{I_{SS}(\mu\text{A})} \quad (2)$$

Where I_{SS} is the internal soft-start charge current (3 μA).

It is recommended that C_{SS} be $\geq 1\text{nF}$.

The device has a pre-biased start-up function. Once EN is pulled above 0.9V, the converter starts up regardless of any pre-biased voltage on the output. Pre-biased start-up works even while the output discharge path is blocked.

Peak Current Limit and Valley Current Limit

Both the HS-FET and LS-FET feature current-limit protection. If I_L reaches the HS-FET’s peak current limit (I_{LIMIT_PEAK}) threshold (typically 5A), the HS-FET turns off and the LS-FET turns on to discharge the energy. The HS-FET does not turn again until I_L drops below the valley current limit (I_{LIMIT_VALLEY}) threshold (typically 3A). This prevents current runaway during overload and short-circuit events.

Short-Circuit Protection (SCP) and SCP Recovery

Short-circuit protection (SCP) protects the circuitries from over-current (OC) faults. If a V_{OUT} short to GND occurs and the device has exceeded its current limit, then SCP is triggered and the IC attempts to recover via hiccup mode. In hiccup mode, the output power stage is disabled and the SS voltage (V_{SS}) is

discharged. Once V_{SS} is discharged completely, the device initiates a new SS. This process repeats until the fault condition is removed.

Over-Voltage Protection (OVP)

The MPQ2179A monitors V_{FB} to detect over-voltage (OV) conditions. If V_{FB} exceeds 115% of V_{REF} , then the converter enters its dynamic regulation period. During this period, the LS-FET remains on until the LS-FET current reaches -1.2A. This process discharges V_{OUT} to keep it within its normal range. If the OV condition still remains after this process, there is a 1.5 μ s delay and then the LS-FET turns on again. Once V_{FB} falls below 105% of V_{REF} , the converter exits the regulation period. If the dynamic regulation period cannot prevent V_{OUT} from increasing and a 6.1V V_{IN} is detected, then over-voltage protection (OVP) is triggered. The device stops switching until V_{IN} drops below 6V. Once V_{IN} drops below 6V, the MPQ2179A resumes normal operation.

Power Good (PG) Indicator

The MPQ2179A has a power good (PG) output to indicate whether the converter is operating normally after start-up. PG is the open drain of an internal MOSFET. It is recommended that this MOSFET's maximum $R_{DS(ON)}$ be below 400 Ω . PG can be connected to V_{IN} or an external voltage source via an external resistor (10k Ω to 100k Ω). Once V_{IN} is applied, the MOSFET turns on and PG is pulled to GND before SS is ready. After V_{FB} reaches 90% of V_{REF} , PG is pulled high by the external voltage source. If V_{FB} drops to 85% of V_{REF} , then the PG voltage (V_{PG}) is pulled to GND to indicate an output failure.

If V_{IN} and EN are not available, and PG is pulled up via an external power supply, then PG self-biases and asserts. If a 100k Ω pull-up resistor is being used, then V_{PG} should be below 0.7V.

APPLICATION INFORMATION

Setting the Output Voltage

The external resistor divider sets the MPQ2179A's adjustable output voltage (V_{OUT}). Select a feedback (FB) resistor ($R1$) to reduce the V_{OUT} leakage current (typically between 10k Ω and 100k Ω). Then $R2$ can then be calculated with Equation (3):

$$R2 = \frac{R1}{\frac{V_{OUT}}{0.6} - 1} \quad (3)$$

Figure 7 shows the FB network.

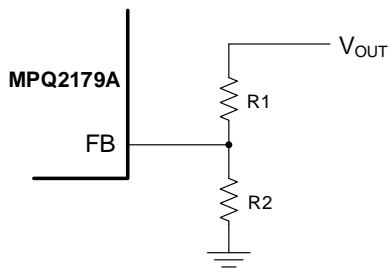

Figure 7: Feedback Network

Table 1 shows the recommended resistor values for common output voltages.

Table 1: Resistor Values for Common Output Voltages

V_{OUT} (V)	$R1$ (k Ω)	$R2$ (k Ω)
1	30.9 (1%)	47 (1%)
1.2	100 (1%)	100 (1%)
1.8	36 (1%)	18 (1%)
2.5	51 (1%)	16 (1%)
3.3	68 (1%)	15 (1%)

Frequency Scaling at Low Input Voltages

Under heavy-load conditions, the HS-FET voltage decreases as the on time (t_{ON}) increases and the duty cycle is extended. If the minimum off time (t_{OFF_MIN}) is reached at a low input voltage and under heavy-load conditions, then f_{SW} scales down. To maintain a constant f_{SW} during heavy-load operation, a larger V_{OUT} is required for a larger V_{IN} . For a 1.8V V_{OUT} at a 2A load, V_{IN} should be above 2.9V to keep f_{SW} above 2MHz. If the frequency begins to scale down, V_{IN} can be estimated with Equation (4):

$$V_{IN} = \frac{V_{OUT} + R_{DS(ON)_HS} \times I_{OUT}}{1 - \frac{t_{OFF_MIN}}{400 \times 10^{-9}}} \quad (4)$$

Where the maximum t_{OFF_MIN} is 125ns. ⁽⁷⁾

Note:

7) Guaranteed by design and bench characterization. Not tested in production.

Selecting the Inductor

A 0.47 μ H to 1.5 μ H inductor is recommended for most applications. For high efficiency, select an inductor with a DC resistance below 25m Ω .

High-frequency, switch-mode power supplies with magnetic devices (such as the MPQ2179A) can have strong electromagnetic interference (EMI). It is recommended to avoid using unshielded power inductors, as they provide poor magnetic shielding. Shielded inductors (e.g. metal alloy or multi-layer chip power inductors) are highly recommended for their effective EMI reduction.

For most designs, the inductance (L_1) can be estimated with Equation (5):

$$L_1 = \frac{V_{OUT} \times (V_{IN} - V_{OUT})}{V_{IN} \times \Delta I_L \times f_{SW}} \quad (5)$$

Where ΔI_L is the inductor ripple current.

Choose an inductor with a ripple current rating that is approximately 30% of the maximum load current (I_{LOAD}). The maximum inductor peak current (I_{L_MAX}) can be calculated with Equation (6):

$$I_{L_MAX} = I_{LOAD} + \frac{\Delta I_L}{2} \quad (6)$$

Selecting the Input Capacitor

The step-down converter has a discontinuous input current (I_{IN}), and requires a capacitor to supply AC current to the converter while maintaining the DC input voltage. For the best performance, it is recommended to use low-ESR capacitors. Ceramic capacitors with X5R or X7R dielectrics are strongly recommended due to their low ESR and small temperature coefficients. For most applications, a 10 μ F capacitor is sufficient. Higher output voltages

may require a 22μF capacitor to increase system stability.

The input capacitor (C1) requires an adequate ripple current rating to absorb the switching I_{IN} .

C1's RMS current rating (I_{C1}) can be estimated with Equation (7):

$$I_{C1} = I_{LOAD} \times \sqrt{\frac{V_{OUT}}{V_{IN}} \times \left(1 - \frac{V_{OUT}}{V_{IN}}\right)} \quad (7)$$

The worst-case scenario occurs at $V_{IN} = 2 \times V_{OUT}$, which can be calculated with Equation (8):

$$I_{C1} = \frac{I_{LOAD}}{2} \quad (8)$$

For simplification, choose an input capacitor with an RMS current rating greater than half of the maximum load current.

C1 can be an electrolytic, tantalum, or ceramic capacitor. When using electrolytic or tantalum capacitors, place a small, high-quality, 0.1μF ceramic capacitor as close to the IC as possible. When using ceramic capacitors, ensure that the capacitor has enough capacitance to prevent excessive voltage ripple at the input. The input voltage ripple (ΔV_{IN}) can be estimated with Equation (9):

$$\Delta V_{IN} = \frac{I_{LOAD}}{f_{SW} \times C1} \times \frac{V_{OUT}}{V_{IN}} \times \left(1 - \frac{V_{OUT}}{V_{IN}}\right) \quad (9)$$

Selecting the Output Capacitor

The output capacitor (C2) stabilizes the DC V_{OUT} . It is recommended to use ceramic capacitors for C2. Low-ESR capacitors are recommended, as they effectively limit the output voltage ripple (ΔV_{OUT}). ΔV_{OUT} can be estimated with Equation (10):

$$\Delta V_{OUT} = \frac{V_{OUT}}{f_{SW} \times L_1} \times \left(1 - \frac{V_{OUT}}{V_{IN}}\right) \times \left(R_{ESR} + \frac{1}{8 \times f_{SW} \times C2}\right) \quad (10)$$

Where L_1 is the inductance, and R_{ESR} is C2's equivalent series resistance (ESR).

When using ceramic capacitors, the capacitance dominates the impedance at the switching frequency and causes the majority of ΔV_{OUT} .

For simplification, ΔV_{OUT} can be estimated with Equation (11):

$$\Delta V_{OUT} = \frac{V_{OUT}}{8 \times f_{SW}^2 \times L_1 \times C2} \times \left(1 - \frac{V_{OUT}}{V_{IN}}\right) \quad (11)$$

Ceramic capacitors with X7R or X5R dielectrics are highly recommended due to their low ESR and small temperature coefficients.

For tantalum or electrolytic capacitors, the ESR dominates the impedance at the switching frequency. For simplification, ΔV_{OUT} can be estimated with Equation (12):

$$\Delta V_{OUT} = \frac{V_{OUT}}{f_{SW} \times L_1} \times \left(1 - \frac{V_{OUT}}{V_{IN}}\right) \times R_{ESR} \quad (12)$$

C2's characteristics can also affect the stability of the regulation system.

Output Discharge Blocking

If the device is disabled, an internal resistive discharge path between the OUT pin and GND is enabled to discharge C2. The discharge path can be blocked by adding an external capacitor between V_{OUT} and the OUT pin (see Figure 8).

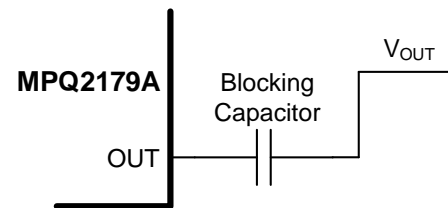

Figure 8: Circuit with V_{OUT} Discharge Blocking

To avoid influencing the loop and load transient, select a ≥ 10 nF blocking capacitor. It is recommended to use a 10nF to 100nF blocking capacitor. A larger-value blocking capacitor does not have an impact on loop performance, but a larger-value capacitor is physically larger and is typically unnecessary for the best results.

PCB Layout Guidelines

Efficient PCB layout is critical for stable operation. Poor layout design can result in poor line regulation, load regulation, and stability issues. For the best results, refer to Figure 9 and follow the guidelines below:

1. Place the high-current paths (GND, VIN, and SW) close to the IC with short, direct, and wide traces.
2. Place the input capacitor (C1) as close to the VIN and GND pins as possible.
3. Place the output capacitor (C2) close to the GND pin.
4. For the adjustable output version, place the external feedback resistors close to the FB pin.
5. Keep the switching node (SW) short and away from the feedback network.
6. Keep the V_{OUT_SENSE} line (OUT) as short as possible, and place it as far away from the inductor as possible. OUT should not surround the inductor or be close to SW.

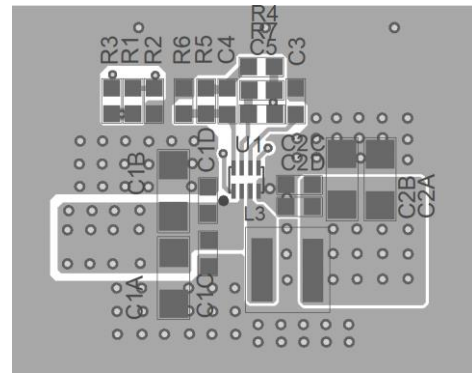

Top Layer

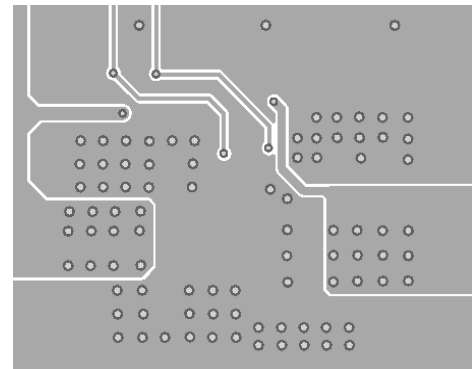

Mid-Layer 2

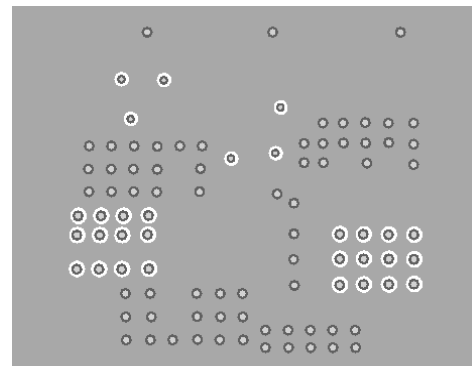

Mid-Layer 1

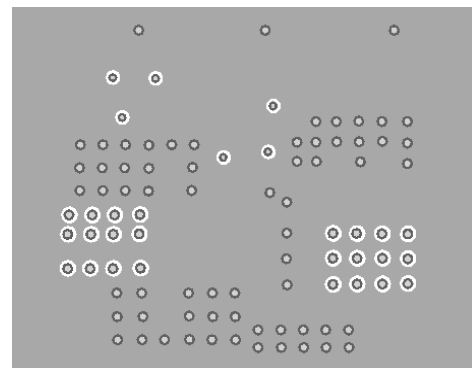

Bottom Layer

Figure 9: Recommended PCB Layout

TYPICAL APPLICATION CIRCUITS

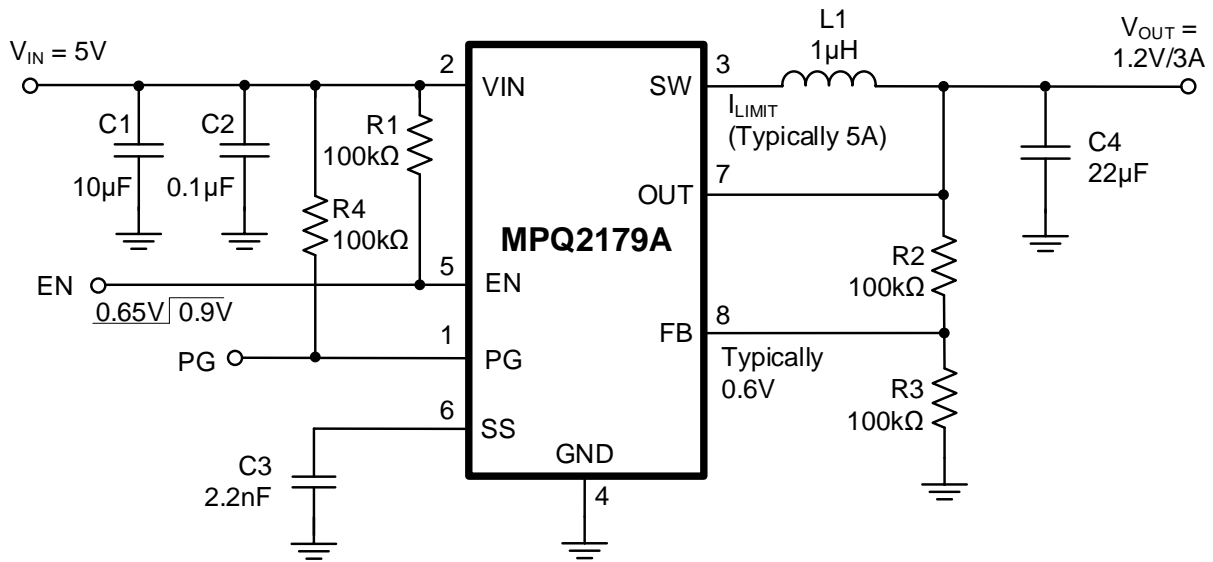

Figure 10: Typical Application Circuit (1.2V Output)

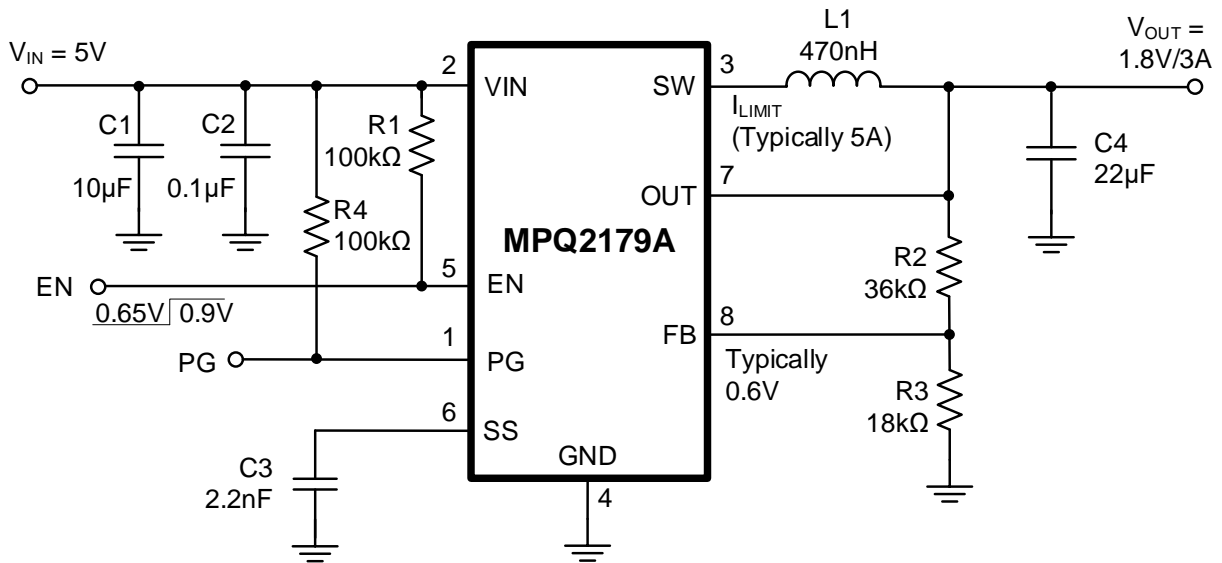
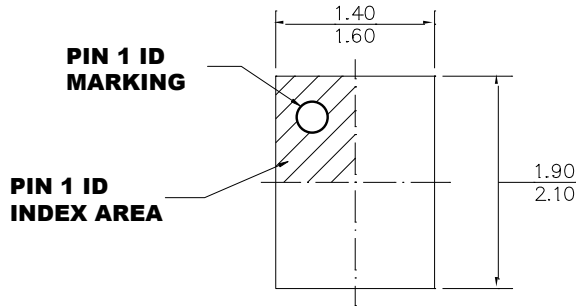

Figure 11: Typical Application Circuit (1.8V Output)

PACKAGE INFORMATION

**QFN-8 (1.5mmx2mm)
Wettable Flank**



TOP VIEW

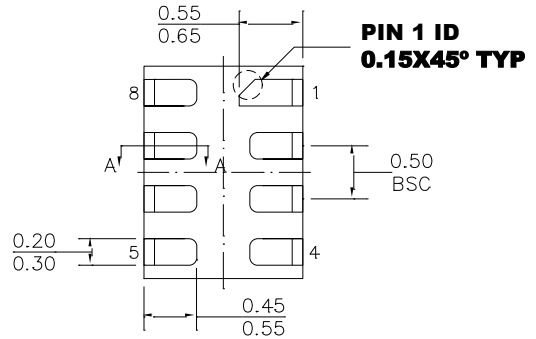

BOTTOM VIEW

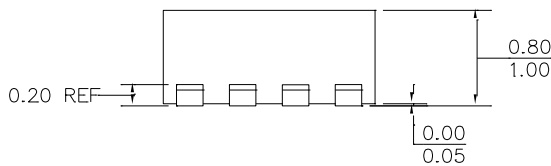

SIDE VIEW

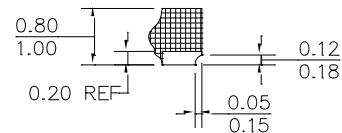

SECTION A-A

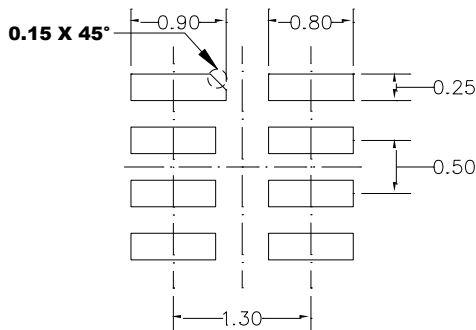

RECOMMENDED LAND PATTERN

NOTE:

- 1) THE LEAD SIDE IS WETTABLE.
- 2) ALL DIMENSIONS ARE IN MILLIMETERS.
- 3) LEAD COPLANARITY SHALL BE 0.08 MILLIMETERS MAX.
- 4) JEDEC REFERENCE IS MO-220.
- 5) DRAWING IS NOT TO SCALE.

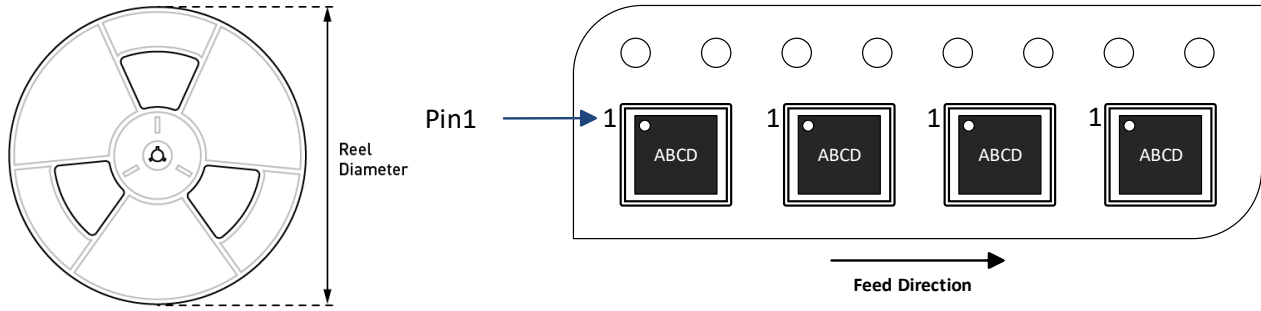
CARRIER INFORMATION

Part Number	Package Description	Quantity /Reel	Quantity /Tube	Quantity /Tube	Reel Diameter	Carrier Tape Width	Carrier Tape Pitch
MPQ2179AGQHE-AEC1-Z	QFN-8 (1.5mmx2mm)	5000	N/A	N/A	13in	8mm	4mm



REVISION HISTORY

Revision #	Revision Date	Description	Pages Updated
1.0	08/06/2021	Initial Release	-

Notice: The information in this document is subject to change without notice. Please contact MPS for current specifications. Users should warrant and guarantee that third-party Intellectual Property rights are not infringed upon when integrating MPS products into any application. MPS will not assume any legal responsibility for any said applications.