



### APPLICATIONS

- Battery-powered devices
- High-efficiency SMPS
- Embedded computing
- Input filters

### FEATURES

- Size 4.9mmx4.9mmx4mm
- Semi-Shielded Construction
- Low DCR
- Low Stray Field
- Max Operating Temp +125°C
- RoHS/REACH-Compliant, Halogen Free

### ELECTRICAL CHARACTERISTICS

Parameter			Value	Unit
Inductance <sup>(1)</sup>	$L$	$\pm 20\%$	1.5	$\mu$ H
Resistance	$R_{DC}$	typ	14	m $\Omega$
Resistance <sub>MAX</sub>	$R_{DC MAX}$	max	17	m $\Omega$
Rated Current <sup>(2)</sup>	$I_R$	typ	6.2	A
Saturation Current <sub>25°C</sub> <sup>(3)</sup>	$I_{SAT 25°C}$	typ	9.3	A
Saturation Current <sub>100°C</sub> <sup>(4)</sup>	$I_{SAT 100°C}$	typ	8.4	A
Resonance Frequency	$f_r$	typ	70	MHz

### GENERAL SPECIFICATIONS

<b>(1) Inductance</b>	Measured at 100kHz, 100mA
<b>(2) Rated Current</b>	Rated current will cause the coil temperature rise $\Delta T$ of 40K <i><math>I_R</math> measured with the inductor soldered in a single-layer PCB. Copper layer thickness 35<math>\mu</math>m Cu / PCB size 30x50mm. Temperature behavior dependent on circuit design, PCB layout, proximity to other components, and trace dimensions and thickness.</i>
<b>(3) Saturation Current <sub>25°C</sub></b>	Saturation current will cause L to drop from 30% at 25°C ambient temperature
<b>(4) Saturation Current <sub>100°C</sub></b>	Saturation current will cause L to drop from 30% at 100°C ambient temperature
<b>Temperature Test Condition</b>	Electrical specifications measured at 25°C, 35% RH if not given differently
<b>Operating Condition</b>	Operating temperature: -40°C to +125°C (including temp rise) Should not exceed +125°C under worst-case operation conditions
<b>Storage Condition</b>	Tape and Reel packaging: -10°C to +40°C Humidity: <50% RH

All MPS parts are lead-free, halogen-free, and adhere to the RoHS directive. For MPS green status, please visit the MPS website under Quality Assurance. "MPS", the MPS logo, and "Simple, Easy Solutions" are registered trademarks of Monolithic Power Systems, Inc. or its subsidiaries.

TYPICAL PERFORMANCE CURVES

Temperature Rise vs. Current

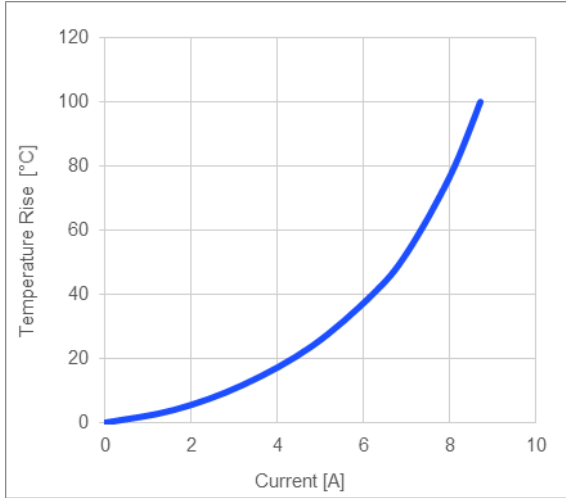

Inductance vs. Current

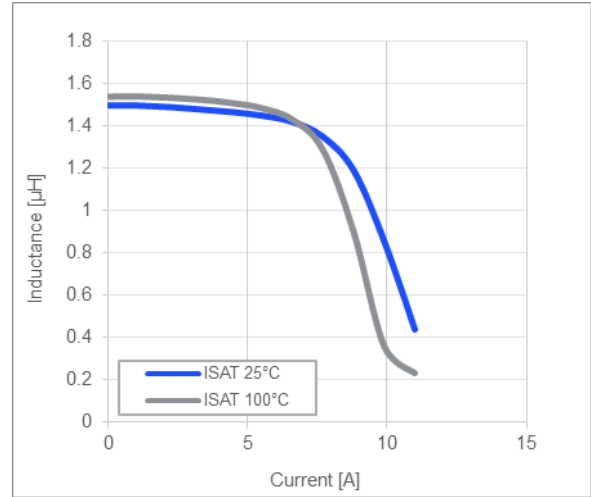

Impedance vs. Frequency

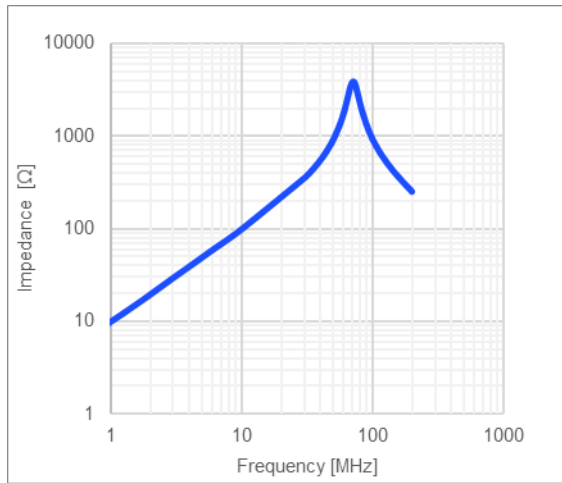

Inductance vs. Frequency

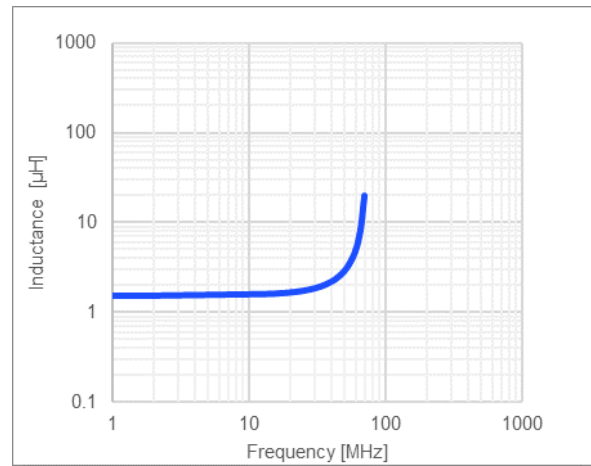

Quality Factor vs. Frequency

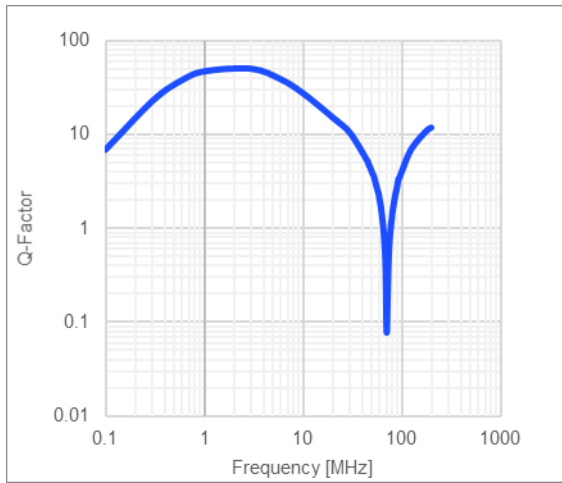

AC Resistance vs. Frequency

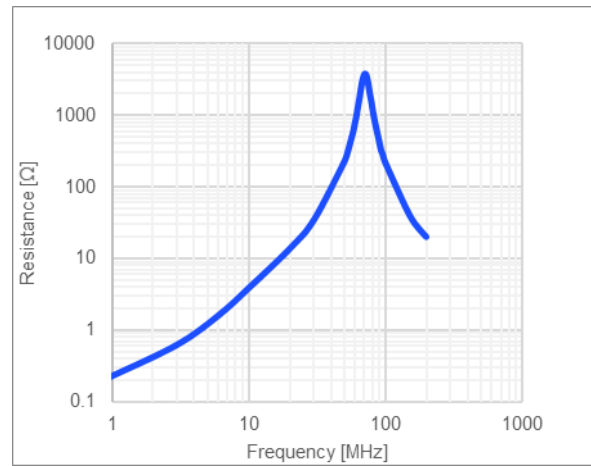

**LAND PATTERN**

Dimensions	
A	4.0 ref.
B	2.10 ref.
C	5.10 ref.

(unit in mm)

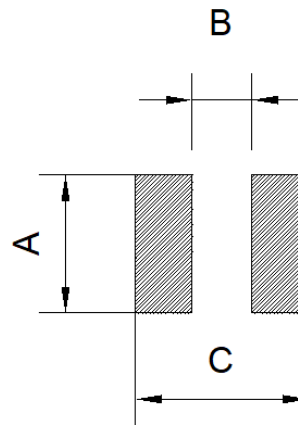

**PRODUCT PACKAGE AND DIMENSIONS**

Dimensions	
------------	--

(unit in mm)

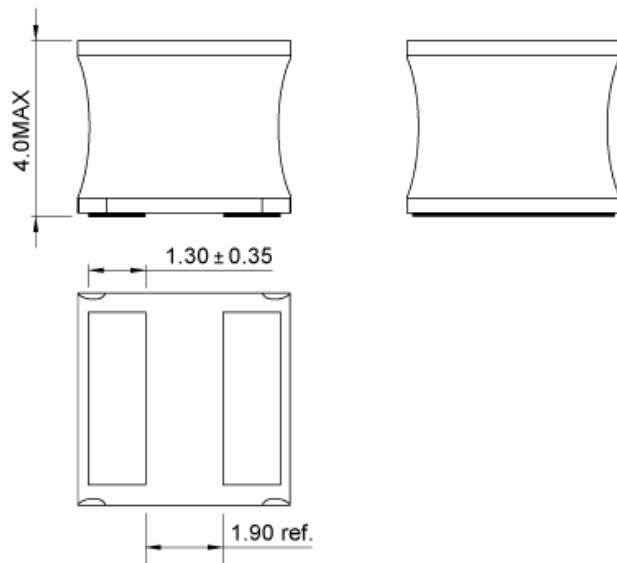
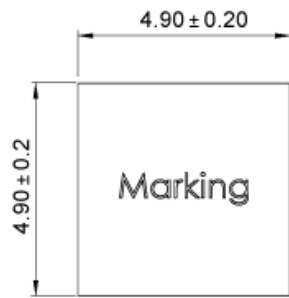

**TOP MARKING**

Marking	
Inductance Code	1R5

**ORDERING INFORMATION**

Part Number	$L^{(1)}$	$R_{DC}$	$I_R^{(2)}$	$I_{SAT\ 25^\circ C}^{(3)}$	$I_{SAT\ 100^\circ C}^{(4)}$
	typ (μH)	typ (mΩ)	typ (A)	typ (A)	typ (A)
MPL-SE5040-R47	0.47	7.3	8.0	16	13.5
MPL-SE5040-1R0	1.0	9.4	7.6	10.5	9
MPL-SE5040-1R5	1.5	14	6.2	9.3	8.4
MPL-SE5040-2R2	2.2	16	5.4	7.9	7.3
MPL-SE5040-3R3	3.3	22	5.2	6.4	5.2
MPL-SE5040-4R7	4.7	33	4.3	5	4.6
MPL-SE5040-6R8	6.8	45	3.5	4.6	4
MPL-SE5040-100	10	56	3.2	3.6	3
MPL-SE5040-150	15	83	2.5	2.9	2.6
MPL-SE5040-220	22	124	2.1	2.4	2.15

**GENERAL SPECIFICATIONS**

<b>(1) Inductance</b>	Measured at 100kHz, 100mA
<b>(2) Rated Current</b>	Rated current will cause the coil temperature rise $\Delta T$ of 40K <i><math>I_R</math> measured with the inductor soldered in a single-layer PCB. Copper layer thickness 35μm Cu / PCB size 30x50mm. Temperature behavior dependent on circuit design, PCB layout, proximity to other components, and trace dimensions and thickness.</i>
<b>(3) Saturation Current <math>_{25^\circ C}</math></b>	Saturation current will cause L to drop from 30% at 25°C ambient temperature
<b>(4) Saturation Current <math>_{100^\circ C}</math></b>	Saturation current will cause L to drop from 30% at 100°C ambient temperature
<b>Temperature Test Condition</b>	Electrical specifications measured at 25°C, 35% RH if not given differently
<b>Operating Condition</b>	Operating temperature: -40°C to +125°C (including temp rise) Should not exceed +125°C under worst-case operation conditions
<b>Storage Condition</b>	Tape and Reel packaging: -10°C to +40°C Humidity: <50% RH

**NOTICE:** The information in this document is subject to change without notice. Please contact MPS for current specifications. Users should warrant and guarantee that third-party Intellectual Property rights are not infringed upon when integrating MPS products into any application. MPS will not assume any legal responsibility for any said applications.