

### DESCRIPTION

The MP6543 family of products are all three-phase brushless DC motor drivers. They integrate three half-bridges, consisting of six N-channel power MOSFETs, along with pre-drivers, gate drive power supplies, and current-sense amplifiers.

The MP6543 has ENABLE and PWM inputs for each ½-H-bridge. The MP6543A has separate high-side and low-side inputs, while the MP6543B has Hall-element inputs. Otherwise, they are similar. References to the MP6543 in this document apply to the other parts, unless otherwise noted.

The MP6543 is able to deliver up to 2A continuously (depending on thermal and PCB conditions), with the adjustable over-current protection threshold. It uses an internal charge pump to generate the gate drive supply voltage for the high-side MOSFETs, and a trickle-charge circuit to maintain sufficient gate drive voltage to operate at 100% duty cycle.

Internal safety features include thermal shutdown, under-voltage lockout (UVLO), and over-current protection (OCP).

The MP6543, MP6543A, and MP6543B are available in a 24-pin, 3mmx4mm QFN package with an exposed thermal pad.

### FEATURES

- 3V to 12V Operating Supply Voltage
- Three Integrated Half-Bridge Drivers
- 2A Continuous Output Current
- MOSFET On Resistance: 110mΩ per FET
- MP6543: ENBL & PWM Inputs  
MP6543A: LS & HS Inputs  
MP6543B: Hall-Signal Inputs
- Built-In 3.3V, 100mA LDO Regulator
- Internal Charge Pump Supports 100% Duty Cycle Operation
- Automatic Synchronous Rectification
- Under-Voltage Lockout (UVLO) and Thermal Shutdown Protection
- Over-Current Protection (OCP) with Adjustable Threshold
- Integrated Bidirectional Current-Sense Amplifiers
- Available in a QFN-24 (3mmx4mm) Package

### APPLICATIONS

- Three-Phase BLDC Motor Drivers

All MPS parts are lead-free, halogen free, and adhere to the RoHS directive. For MPS green status, visit the MPS website under Quality Assurance. "MPS", the MPS logo, and "Simple, Easy Solutions" are registered trademarks of Monolithic Power Systems, Inc. or its subsidiaries.

### TYPICAL APPLICATION

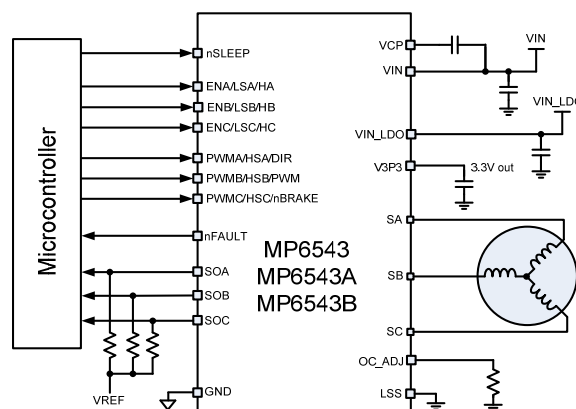

MP6543/6543A/6543B Typical Application Circuit (QFN-24 3mmx4mm)

**ORDERING INFORMATION**

Part Number	Package	Top Marking
MP6543GL*	QFN-24 (3mmx4mm)	See Below
MP6543AGL**		
MP6543BGL***		

\* For Tape & Reel, add suffix -Z (e.g. MP6543GL-Z).

\*\*For Tape & Reel, add suffix -Z (e.g. MP6543AGL-Z).

\*\*\*For Tape & Reel, add suffix -Z (e.g. MP6543BGL-Z).

**TOP MARKING (MP6543GL)**

MPYW

6543

LLL

MP: MPS prefix

Y: Year code

W: Week code

6543: First four digits of the part number

LLL: Lot number

**TOP MARKING (MP6543AGL)**

MPYW

6543

ALLL

MP: MPS prefix

Y: Year code

W: Week code

6543A: First five digits of the part number

LLL: Lot number

**TOP MARKING (MP6543BGL)**

MPYW

6543

BLLL

MP: MPS prefix

Y: Year code

W: Week code

6543B: First five digits of the part number

LLL: Lot number

### PACKAGE REFERENCE

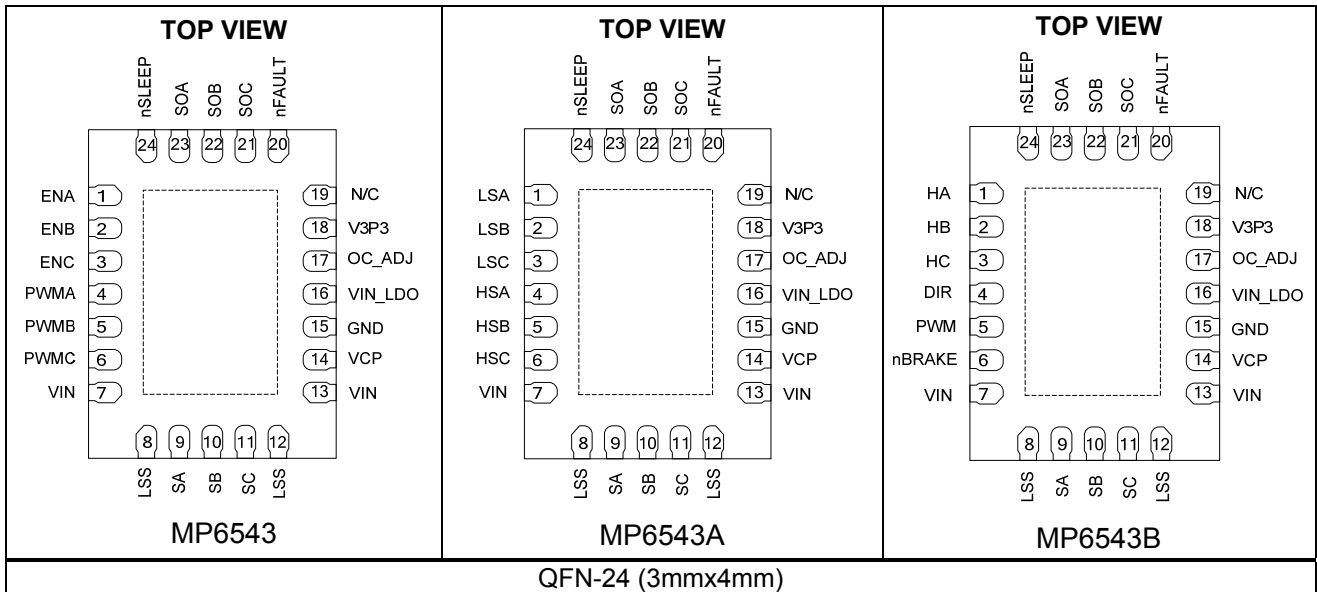

### PIN FUNCTIONS

Pin #	MP6543 Name	MP6543A Name	MP6543B Name	Description
1	ENA	-	-	Enable input for phase A.
	-	LSA	-	Enable LS-FET for phase A.
	-	-	HA	Hall-sensor input, phase A.
2	ENB	-	-	Enable input for phase B.
	-	LSB	-	Enable LS-FET for phase B.
	-	-	HB	Hall-sensor input, phase B.
3	ENC	-	-	Enable input for phase C.
	-	LSC	-	Enable LS-FET for phase C.
	-	-	HC	Hall-sensor input, phase C.
4	PWMA	-	-	PWM input for phase A.
	-	HSA	-	Enable HS-FET for phase A.
	-	-	DIR	Logic input to determine the direction of motor torque output.
5	PWMB	-	-	PWM input for phase B.
	-	HSB	-	Enable HS-FET for phase B.
	-	-	PWM	External PWM control for speed/torque.
6	PWMC	-	-	PWM input for phase C.
	-	HSC	-	Enable HS-FET for phase C.
	-	-	nBRAKE	Active-low logic input for a braking function.

**PIN FUNCTIONS (continued)**

Pin #	MP6543 Name	MP6543A Name	MP6543B Name	Description
7		VIN		<b>Input power.</b>
8		LSS		<b>Low-side source connection for phases A, B, and C.</b> Must be connected directly to GND.
9		SA		<b>Phase A output.</b>
10		SB		<b>Phase B output.</b>
11		SC		<b>Phase C output.</b>
12		LSS		<b>Low-side source connection for phases A, B, and C.</b> Must be connected directly to GND.
13		VIN		<b>Input power.</b>
14		VCP		<b>Charge pump output.</b> Connect a 1 $\mu$ F ceramic capacitor to VIN.
15		GND		<b>Ground.</b>
16		VIN_LDO		<b>LDO input.</b>
17		OC_ADJ		<b>Over-current threshold programming pin.</b>
18		V3P3		<b>3.3V regulator output.</b> Low-side gate driver supply voltage. Bypass to GND with a 0.47 $\mu$ F ceramic capacitor.
19		N/C		<b>No connection.</b>
20		nFAULT		<b>Fault indication.</b> Open-drain output type, logic low when in fault condition.
21		SOC		<b>Current-sense output for phase C.</b>
22		SOB		<b>Current-sense output for phase B.</b>
23		SOA		<b>Current-sense output for phase A.</b>
24		nSLEEP		<b>Sleep mode input.</b> Logic low to enter low-power sleep mode. Internal pull-down.

**ABSOLUTE MAXIMUM RATINGS** <sup>(1)</sup>

Supply voltage (V <sub>IN</sub> , V <sub>IN_LDO</sub> )	-0.3V to +18V
V <sub>SX</sub>	-0.3V to V <sub>IN</sub> +0.3V
V <sub>CP</sub>	-0.3V to V <sub>IN</sub> +5V
AGND to PGND	-0.3V to +0.3V
Voltage at all other pins	-0.3 to +5V
Continuous power dissipation (T <sub>A</sub> = 25°C) <sup>(2)</sup>	
QFN-24 (3mmx4mm)	2.6W
Junction temperature	150°C
Lead temperature	260°C
Storage temperature	-65°C to +150°C

**Recommended Operating Conditions** <sup>(3)</sup>

Supply voltage (V <sub>IN</sub> )	3V to 12V
Operating junction temp (T <sub>J</sub> )	-40°C to +125°C

<b>Thermal Resistance</b> <sup>(4)</sup>	<b><math>\theta_{JA}</math></b>	<b><math>\theta_{JC}</math></b>
QFN-24 (3mmx4mm)	48	10

**Notes:**

- Exceeding these ratings may damage the device.
- The maximum allowable power dissipation is a function of the maximum junction temperature T<sub>J</sub> (MAX), the junction-to-ambient thermal resistance  $\theta_{JA}$ , and the ambient temperature T<sub>A</sub>. The maximum allowable continuous power dissipation at any ambient temperature is calculated by P<sub>D</sub> (MAX) = (T<sub>J</sub> (MAX) - T<sub>A</sub>) /  $\theta_{JA}$ . Exceeding the maximum allowable power dissipation may cause excessive die temperature, and the regulator to go into thermal shutdown. Internal thermal shutdown circuitry protects the device from permanent damage.
- The device is not guaranteed to function outside of its operating conditions.
- Continuous current depends on PCB layout and ambient temperature.
- Measured on JESD51-7, 4-layer PCB.

**ELECTRICAL CHARACTERISTICS**
**V<sub>IN</sub> = 10V, T<sub>A</sub> = 25°C, LSS = GND = 0V, unless otherwise noted.**

Parameter	Symbol	Condition	Min	Typ	Max	Units
<b>Power Supply</b>						
Input supply voltage	V <sub>IN</sub> , V <sub>IN_LDO</sub>		3		12	V
Quiescent current	I <sub>Q</sub>	nSLEEP = 1, ENx = 0		2.5	3.2	mA
	I <sub>SLEEP</sub>	nSLEEP = 0		45	60	μA
<b>Control Logic</b>						
Input logic low threshold	V <sub>IL</sub>				0.4	V
Input logic high threshold	V <sub>IH</sub>		1.5			V
Logic input current	I <sub>IN(H)</sub>	V = 3.3V	-20		20	μA
	I <sub>IN(L)</sub>	V = 0V	-20		20	μA
Power-up delay	t <sub>PUD</sub>	At V <sub>IN</sub> rising or nSLEEP rising		1.5		ms
Internal pull-down resistance	R <sub>PD</sub>	All logic Inputs		500		kΩ
nFAULT pull-down R <sub>ON</sub>	R <sub>ON(NFAULT)</sub>			15		Ω
<b>V3P3 REGULATOR</b>						
LDO output		I <sub>OUT</sub> = 0 to 100 mA	3.3	3.45	3.6	V
<b>Protection Circuits</b>						
UVLO threshold	V <sub>UVLO</sub>	V <sub>IN</sub> rising	2.5	2.7	2.9	V
UVLO hysteresis	ΔV <sub>UVLO</sub>			150		mV
OCP threshold	I <sub>OCP</sub>	ROCP = 0	4.7	6.2	8	A
		ROCP = float	5.5	7.2	9	A
OCP deglitch time	t <sub> OCD</sub>			1		μs
Thermal shutdown <sup>(6)</sup>	T <sub>TSD</sub>	T <sub>J</sub> rising		160		°C
Thermal shutdown hysteresis <sup>(6)</sup>	ΔT <sub>TSD</sub>			25		°C
<b>Current Sense</b>						
Current-sense ratio			1/3600	1/4000	1/4400	A/A
Current-sense output current		LS-FET current = 1A	225	250	275	μA
		LS-FET current = -1A	-275	-250	-225	μA
Current-sense output current		LS-FET current = 100mA	22.5	25	27.5	μA
		LS-FET current = -100mA	-27.5	-25	-22.5	μA
Positive and negative matching (ratio of positive to negative)		LS-FET current = ±1A, ±100mA	95%	1	105%	
Phase matching (ratio of phase to phase)		LS-FET current = ±1A, ±100mA	95%	1	105%	
Current-sense output voltage swing		LS-FET current = ±0.25A	0		3.6	V
<b>Output</b>						
HS-FET on resistance	R <sub>ON(HS)</sub>	I <sub>OUT</sub> = 1A	90	110	135	mΩ
LS-FET on resistance	R <sub>ON(LS)</sub>	I <sub>OUT</sub> = 1A	85	105	125	
Output rise time <sup>(6)</sup>		R <sub>LOAD</sub> = 50Ω		25		ns
Output fall time <sup>(6)</sup>		R <sub>LOAD</sub> = 50Ω		25		ns
Dead time <sup>(6)</sup>		R <sub>LOAD</sub> = 50Ω		40		ns

**ELECTRICAL CHARACTERISTICS (continued)**
 **$V_{IN} = 10V$ ,  $T_A = 25^{\circ}C$ ,  $LSS = GND = 0V$ , unless otherwise noted.**

Parameter	Symbol	Condition	Min	Typ	Max	Units
PWMx to Sx delay time rising <sup>(6)</sup>				70		ns
PWMx to Sx delay time falling <sup>(6)</sup>				70		ns
<b>Charge Pump</b>						
Charge pump output voltage	$V_{CP}$			$V_{IN} + 3.3$		V

**Note:**

6) Guaranteed by design.

## TYPICAL CHARACTERISTICS

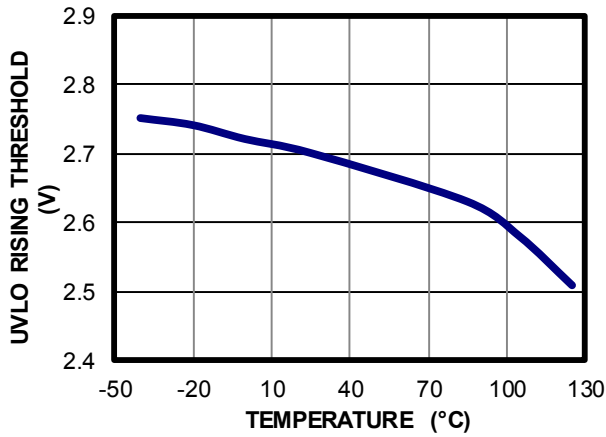
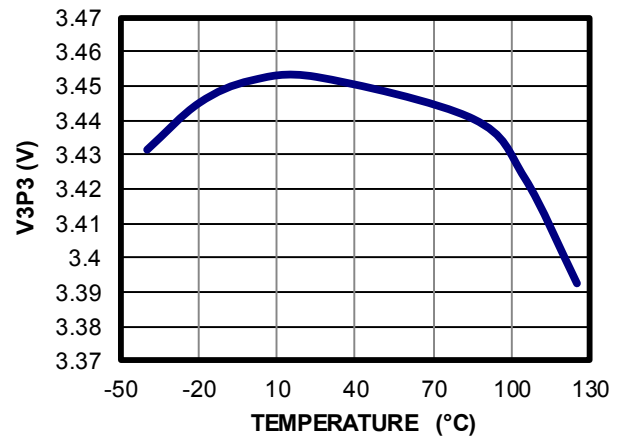
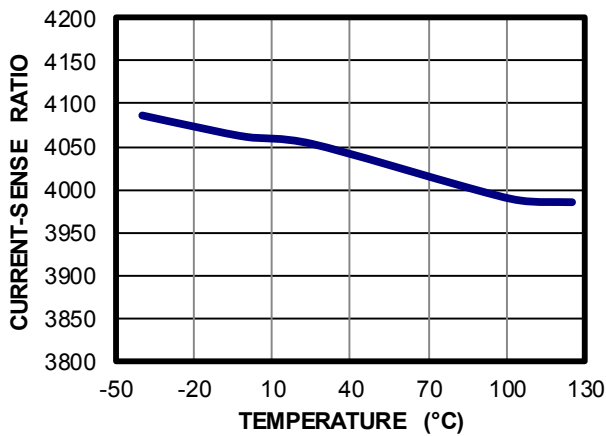
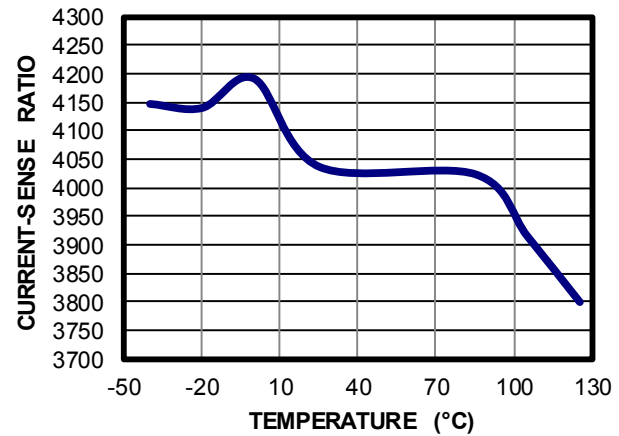
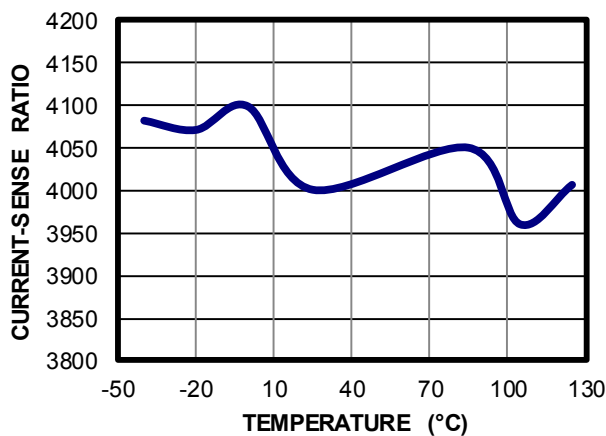
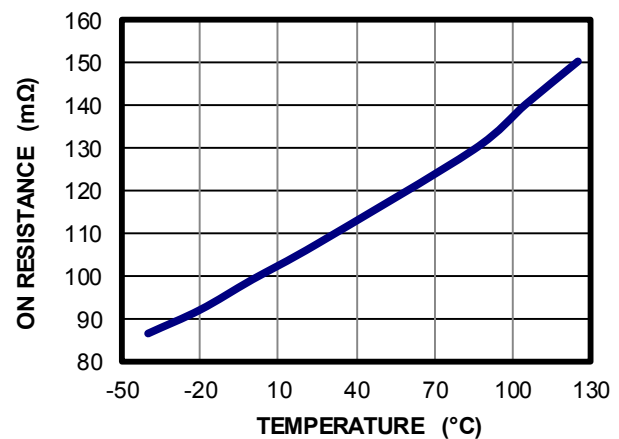
**UVLO Rising Threshold vs. Temperature**

**V3P3 vs. Temperature**
 $V_{IN\_LDO} = 10V, LDO\_LOAD = 100mA$ 

**A-Phase Current-Sense Ratio vs. Temperature**
 $I_{OUT} = 1A$ 

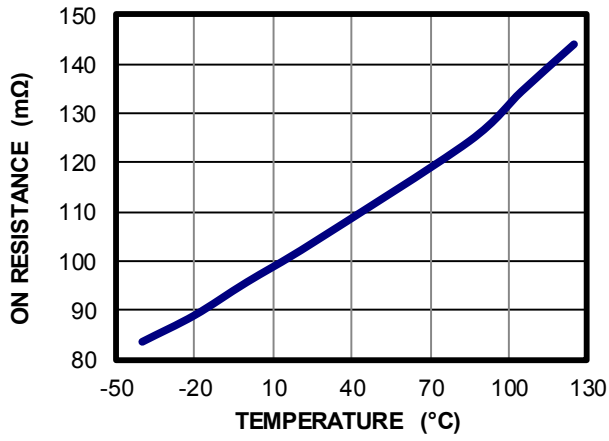
**B-Phase Current-Sense Ratio vs. Temperature**
 $I_{OUT} = 1A$ 

**C-Phase Current-Sense Ratio vs. Temperature**
 $I_{OUT} = 1A$ 

**HS On Resistance vs. Temperature**
 $I_{OUT} = 1A$ 

TYPICAL CHARACTERISTICS (continued)

LS On Resistance vs. Temperature  
 $I_{OUT} = 1A$





## TYPICAL PERFORMANCE CHARACTERISTICS

$V_{IN} = V_{IN\_LDO} = 10V$ , A-phase switching with 20kHz frequency, B-phase LS on, C-phase disable,  
 $V_{REF} = 3.3V$ , current-sense resistor divider = 5k $\Omega$ ,  $T_A = 25^\circ C$ , resistor + inductor load: 2 $\Omega$  +  
 0.2mH/phase with star connection, unless otherwise noted.

### Steady State

Duty = 10%

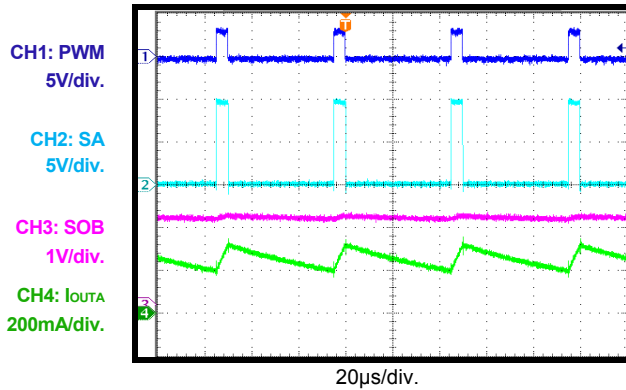

### Steady State

Duty = 50%

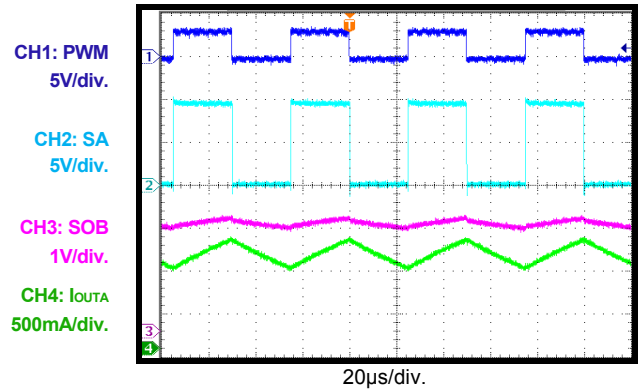

### Steady State

Duty = 90%

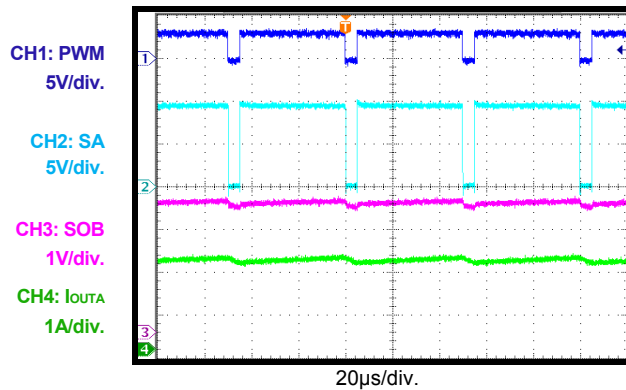

### Power Ramp-Up

Duty = 10%

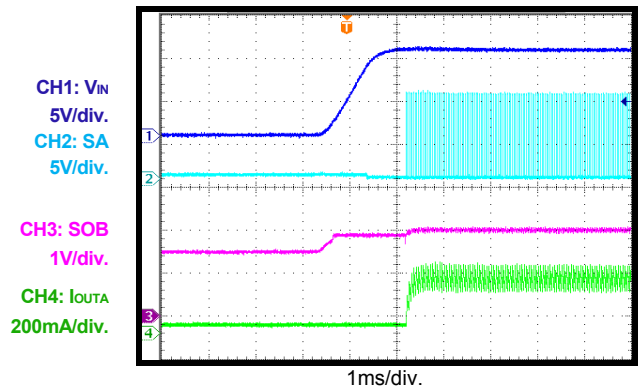

### Power Ramp-Up

Duty = 50%

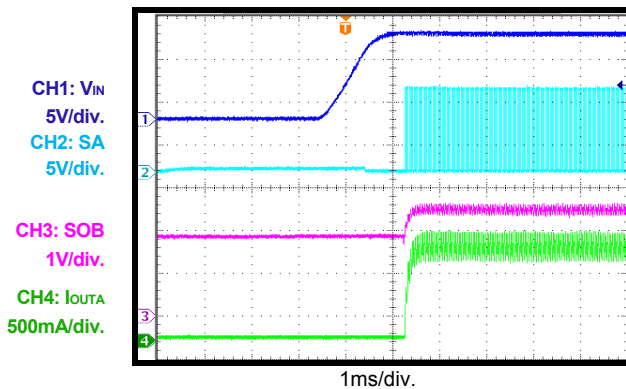

### Power Ramp-Up

Duty = 90%

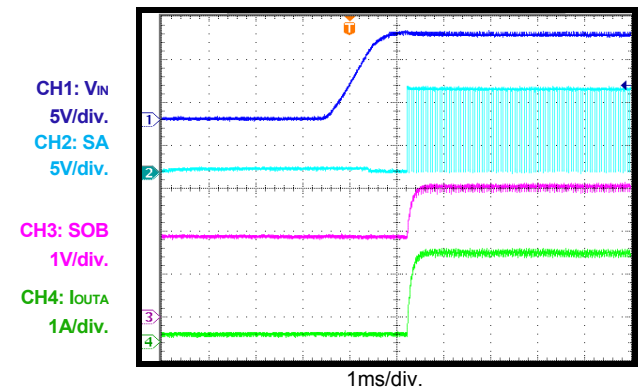

**TYPICAL PERFORMANCE CHARACTERISTICS (continued)**

$V_{IN} = V_{IN\_LDO} = 10V$ , A-phase switching with 20kHz frequency, B-phase LS on, C-phase disable,  
 $V_{REF} = 3.3V$ , current-sense resistor divider = 5k $\Omega$ ,  $T_A = 25^\circ C$ , resistor + inductor load: 2 $\Omega$  +  
 0.2mH/phase with star connection, unless otherwise noted.

**Power Ramp-Down**

Duty = 10%

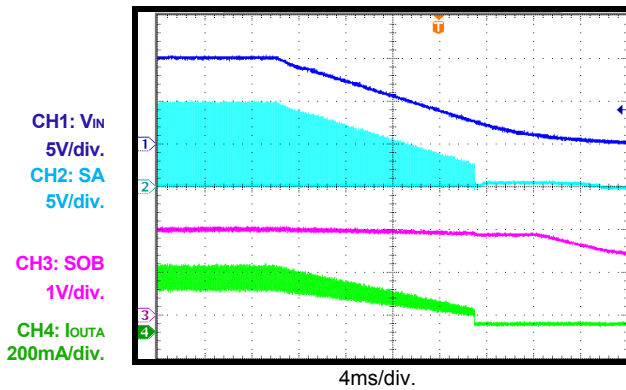
**Power Ramp-Down**

Duty = 50%

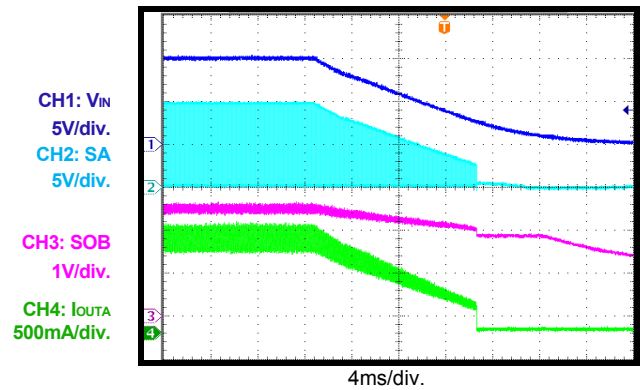
**Power Ramp-Down**

Duty = 90%

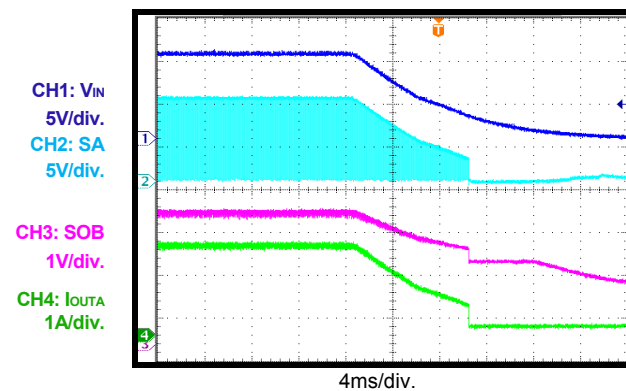
**Sleep Recovery**

Duty = 10%

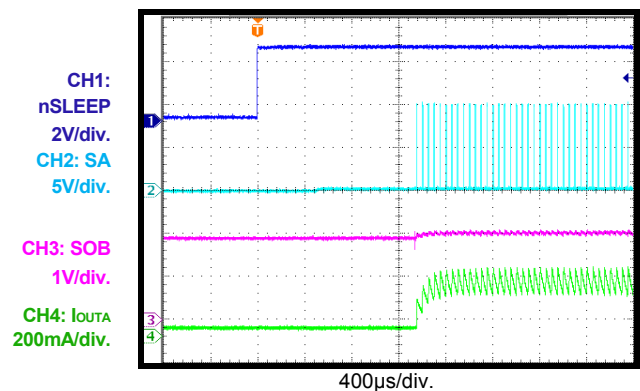
**Sleep Recovery**

Duty = 50%

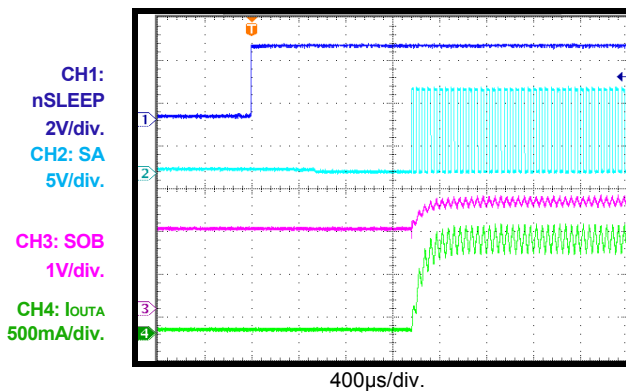
**Sleep Recovery**

Duty = 90%

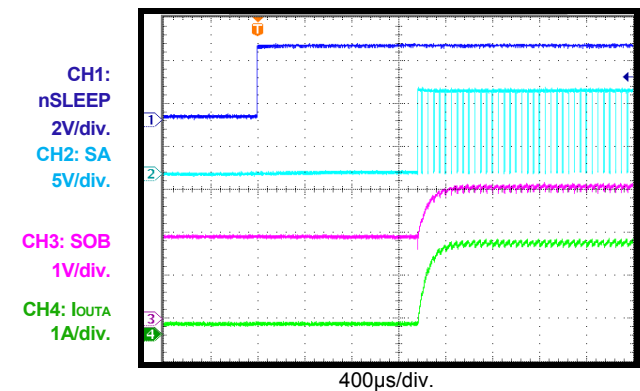

**TYPICAL PERFORMANCE CHARACTERISTICS (continued)**

$V_{IN} = V_{IN\_LDO} = 10V$ , A-phase switching with 20kHz frequency, B-phase LS on, C-phase disable,  
 $V_{REF} = 3.3V$ , current-sense resistor divider = 5k $\Omega$ ,  $T_A = 25^\circ C$ , resistor + inductor load: 2 $\Omega$  +  
 0.2mH/phase with star connection, unless otherwise noted.

**Sleep Entry**

Duty = 10%

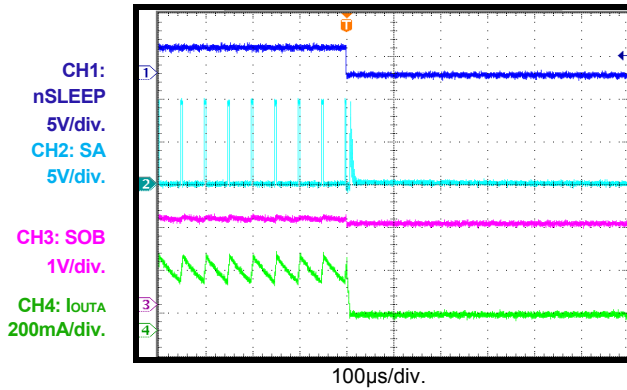
**Sleep Entry**

Duty = 50%

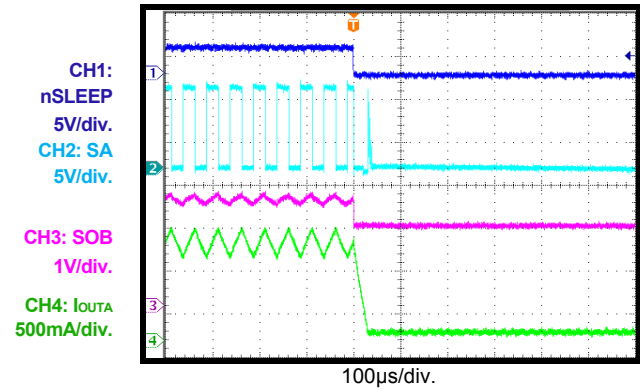
**Sleep Entry**

Duty = 90%

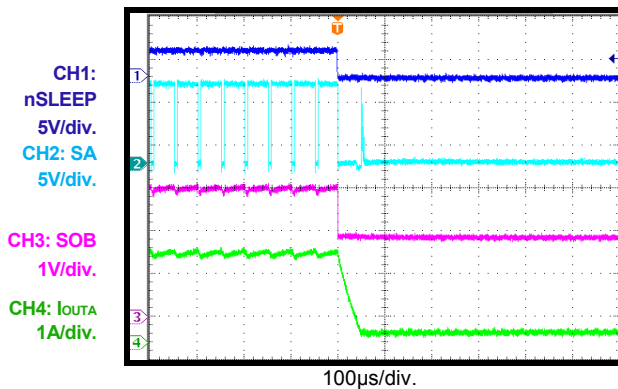

FUNCTIONAL BLOCK DIAGRAM (MP6543/MP6543A/MP6543B)

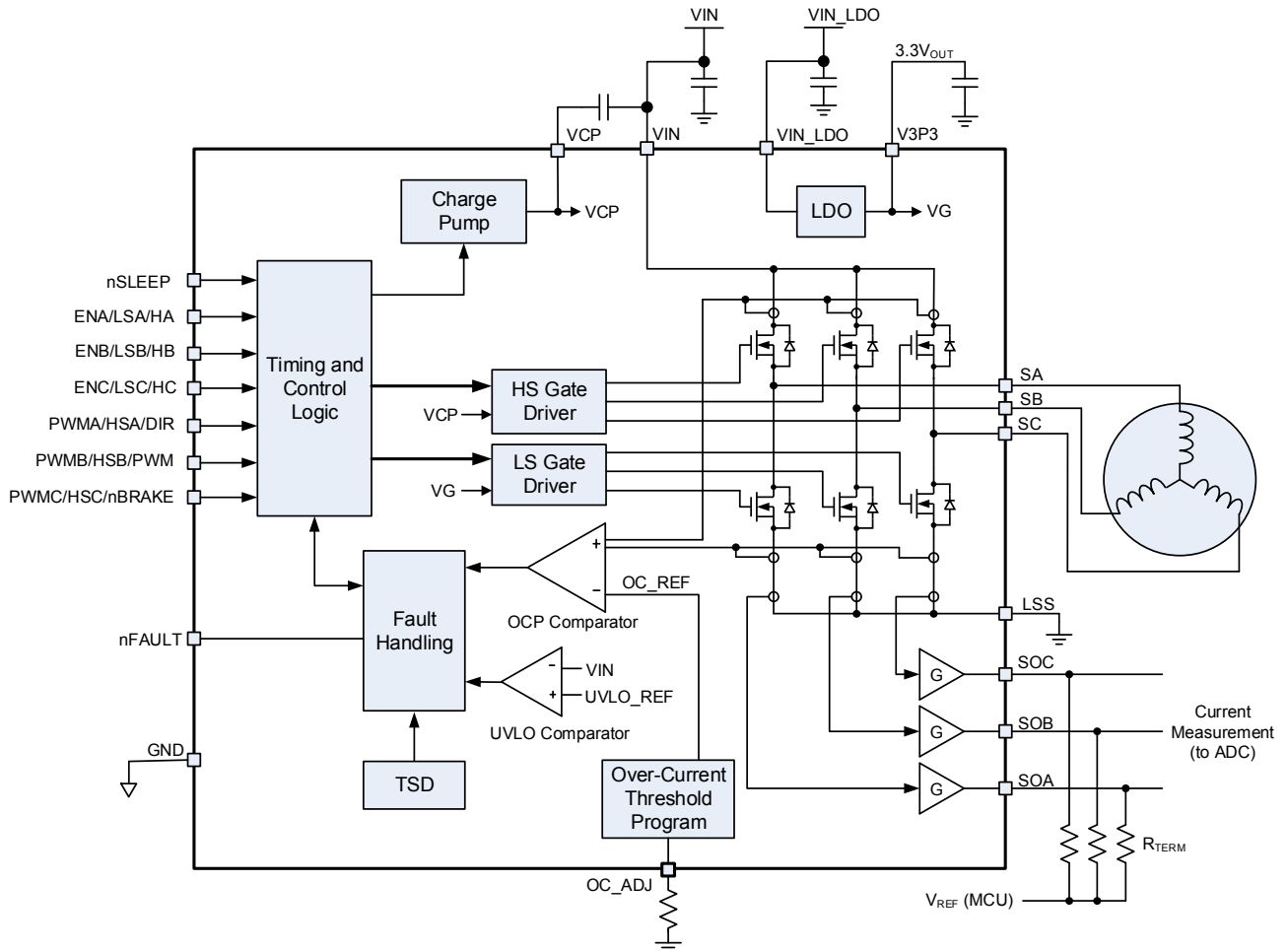

Figure 1: Functional Block Diagram

## OPERATION

The MP6543 is a three-channel half-bridge driver intended to drive a brushless DC motor.

### Input Logic

The MP6543 has logic input pins ENA, ENB, and ENC, which enable the outputs SA, SB, and SC. When ENx is low, the corresponding output is disabled (output is high-impedance), and the PWM input on that phase is ignored. When ENx is high, the output is enabled, and the PWM input controls the state of the output. Table 1.1 shows the logic truth table.

**Table 1.1: Input Logic Truth Table of the MP6543**

ENx	PWMx	Sx
H	H	VIN
H	L	GND
L	X	High impedance

The MP6543A has separate inputs to enable the HS-FETs and LS-FETs of each phase independently. Table 1.2 shows the logic truth table.

**Table 1.2: Input Logic Truth Table of the MP6543A**

HSx	LSx	Sx
L	L	High impedance
L	H	GND
H	L	VIN
H	H	High impedance

The MP6543B has three Hall-element inputs, whose commutation logic is determined by three Hall-element inputs spaced at 120°. The PWM, DIR, and nBRAKE inputs control motor speed, direction, and brake engagement, respectively.

**Table 1.3: Input Logic Truth Table of the MP6543B**

PWM	nBRAKE	Operation Mode
0	1	PWM chop mode – the load current decays
0	0	Brake mode – all low-side gates on
1	1	Selected drivers on
1	0	Brake mode – all low-side gates on

**Table 2: Commutation Table of the MP6543B (nBRAKE = 1)**

Logic Inputs				Motor Terminals		
HA	HB	HC	DIR	SA	SB	SC
1	0	1	1	PWM	Z	L
1	0	0	1	Z	PWM	L
1	1	0	1	L	PWM	Z
0	1	0	1	L	Z	PWM
0	1	1	1	Z	L	PWM
0	0	1	1	PWM	L	Z
1	0	1	0	L	Z	PWM
0	0	1	0	L	PWM	Z
0	1	1	0	Z	PWM	L
0	1	0	0	PWM	Z	L
1	1	0	0	PWM	L	Z
1	0	0	0	Z	L	PWM
0	0	0	X	Z	Z	Z
1	1	1	X	Z	Z	Z

Note that the logic inputs have internal weak pull-down resistors.

### nSLEEP Operation

Driving nSLEEP low puts the device into a low-power sleep state. In this state, all internal circuits are disabled. All inputs are ignored when nSLEEP is active low. When waking up from sleep mode, approximately 1.5ms must pass before the device responds to inputs. The nSLEEP input has a weak pull-down resistor.

### Current-Sense Amplifiers

The current flowing in each of the three outputs is sensed by internal current-sensing circuits. An output pin for each phase sources or sinks a current that is proportional to the current flowing in each phase. Note that only current flowing in the LS-FET is sensed, and that it is sensed in both the forward and reverse directions.

To convert this current into a voltage (e.g. to input to an A/D converter), a termination resistor ( $R_{REF}$ ) is used as a reference voltage. When there is no current flowing, the resultant output will be equal to the reference voltage. When current is flowing, the voltage is above or below the reference voltage, determined with Equation (1):

$$V_{SOUT} = V_{REF} + (R_{REF} * I_{LOAD}) / 4000 \quad (1)$$

To terminate the outputs when using an A/D converter with inputs that are ratiometric to its supply voltage, use two equal-value resistors to the ADC supply and ground. The resulting ADC code will be half-scale at zero current. Figure 2 shows a simplified drawing of the current measurement circuit.

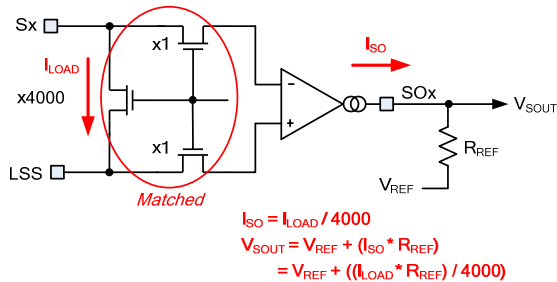

Figure 2: Current Measurement Circuit Diagram

**Automatic Synchronous Rectification**

When driving current through an inductive load, if the output MOSFETs are both turned off, the recirculation current must continue to flow. This current is normally passed through the MOSFET body diodes. To prevent excess power dissipation in the body diodes, the MP6543 implements automatic synchronous rectification.

When both the HS-FET and LS-FET are turned off and the voltage on an Sx output pin is driven below ground, the LS-FET turns on until the current flowing through it reaches zero, or the HS-FET turns on. Similarly, if the voltage on the Sx pin rises above V<sub>IN</sub>, the HS-FET turns on until the current reaches zero, or the LS-FET turns on.

**nFAULT Output**

The MP6543 provides an nFAULT output pin, which is driven active low in a fault condition, such as over-current protection (OCP) or over-temperature protection (OTP). This pin is an open-drain output, and must be pulled up by an external pull-up resistor.

**Input UVLO Protection**

If the voltage on VIN falls below the UVLO threshold, all circuitry in the device is disabled and the internal logic is reset. Normal operation resumes when V<sub>IN</sub> rises above the UVLO threshold.

**Thermal Shutdown**

If the die temperature exceeds safe limits, all output FETs are disabled and nFAULT is driven

low. Normal operation resumes when the die temperature has fallen to a safe level.

**Over-Current Protection**

The OCP circuit limits the current through each FET by disabling its gate driver. If the over-current limit threshold is reached, and lasts for longer than the over-current deglitch time, all six output FETs are disabled (outputs become high-impedance) and nFAULT is driven low. The current is then recirculated through the body diodes. The over-current shutdown is latched until either nSLEEP is reset or VIN is power-cycled.

Over-current conditions on both high-side and low-side devices (e.g. a short to ground, supply, or across the motor winding) all result in an over-current shutdown. Figure 3 shows a simplified diagram of the OCP circuit for one output.

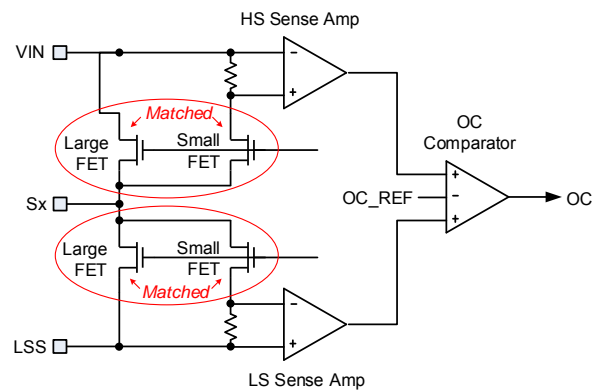

Figure 3: OCP Circuit

OC\_ADJ values are outside the specified value range for over-current threshold.

Table 3: Over-Current Threshold

OC_ADJ Resistor Value	Typ OC Threshold
0	6.2A
Float	7.2A

**3.3V LDO Output**

An internal LDO regulator generates a 3.3V voltage with 100mA capacity, which can be used to power a small low-power microcontroller. A bypass capacitor between 4.7µF and 10µF is required from the V3P3 pin to ground.

**Charge Pump**

A charge pump is used to generate the gate drive for the high-side FETs. The charge pump requires one external, 1 $\mu$ F ceramic capacitor rated for at least 10V between VIN and VCP.

PACKAGE INFORMATION

QFN-24 (3mmx4mm)

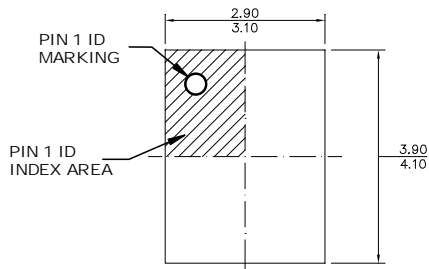

TOP VIEW

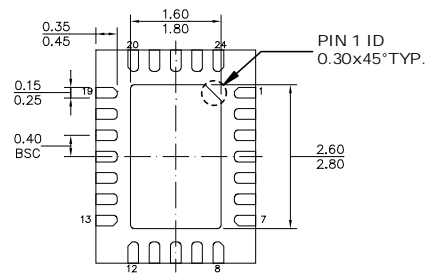

BOTTOM VIEW

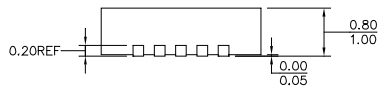

SIDE VIEW

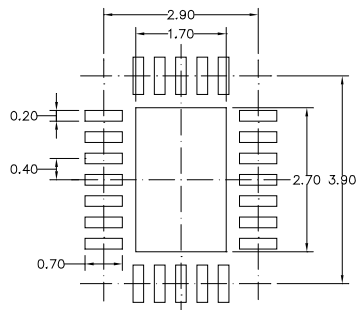

RECOMMENDED LAND PATTERN

NOTE:

- 1) ALL DIMENSIONS ARE IN MILLIMETERS.
- 2) EXPOSED PADDLE SIZE DOES NOT INCLUDE MOLD FLASH.
- 3) LEAD COPLANARITY SHALL BE 0.08 MILLIMETERS MAX.
- 4) JEDEC REFERENCE IS MO-220.
- 5) DRAWING IS NOT TO SCALE.

**NOTICE:** The information in this document is subject to change without notice. Please contact MPS for current specifications. Users should warrant and guarantee that third-party Intellectual Property rights are not infringed upon when integrating MPS products into any application. MPS will not assume any legal responsibility for any said applications.