

DESCRIPTION

The MP62055-3 Power Distribution Switch features internal current limiting to prevent damage to host devices due to faulty load conditions. The MP62055-3 analog switch features 90mΩ on-resistance and operates from 2.7V to 5.5V input. It is available with a guaranteed current limit, making it ideal for load switching applications. The MP62055-3 has built-in protection for both over current and increased thermal stress. For over current, the device will limit the current by changing to a constant current mode.

As the temperature increases as a result of short circuit, the device will shut off. The device will recover once the device temperature reduces to approx 120°C.

The MP62055-3 is available in TSOT23-5 or SOIC8 package without exposed pad.

FEATURES

- 10μs Response Time of Current Limit
- 500mA Continuous Current
- Accurate Current Limit
- 2.7V to 5.5V Supply Range
- 90uA Quiescent Current
- 90mΩ MOSFET (SOIC8)
- 115mΩ MOSFET (TSOT23-5)
- Thermal-Shutdown Protection
- Under-Voltage Lockout
- 8ms FLAG Deglitch Time
- Reverse Current Blocking
- TSOT23-5 & SOIC8 Package

APPLICATIONS

- Smartphone and PDA
- Portable GPS Device
- Set-top-box
- USB Power Distribution

"MPS" and "The Future of Analog IC Technology" are Trademarks of Monolithic Power Systems, Inc.

TYPICAL APPLICATION

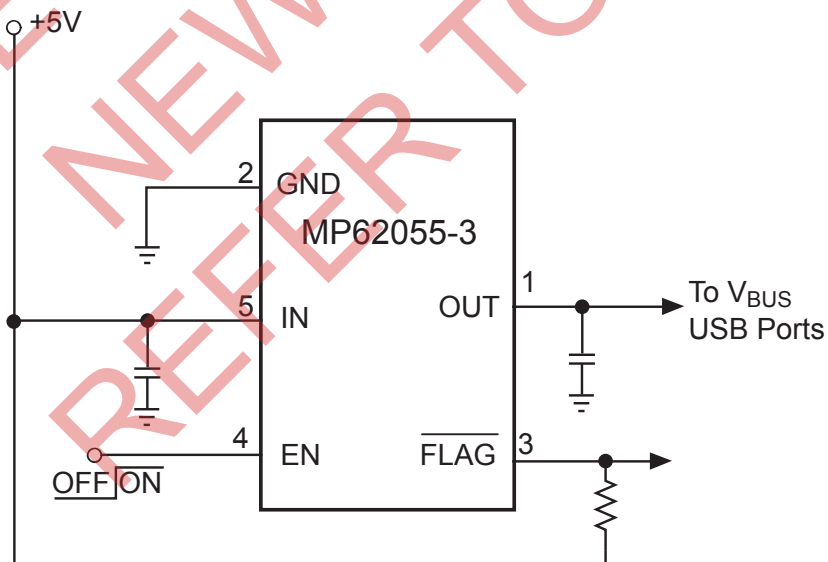

SINGLE-CHANNEL
(For TSOT23-5)

ORDERING INFORMATION

Part Number*	Enable	Switch	Maximum Continuous Load Current	Maximum Short-Circuit Current @ T _A =25°C	Package	Free Air Temperature (T _A)
MP62055ES-3	Active High	Single	500mA	1100mA	SOIC8	-20°C to +85°C
MP62055EJ-3	Active High	Single	500mA	1100mA	TSOT23-5	-20°C to +85°C

* For Tape & Reel, add suffix -Z (eg. MP62055ES-3 -Z).
 For RoHS Compliant Packaging, add suffix -LF (eg. MP62055ES-3-LF-Z)

PACKAGE REFERENCE

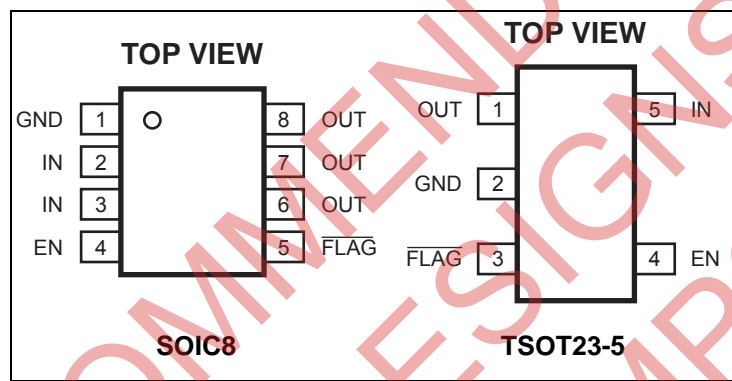

ABSOLUTE MAXIMUM RATINGS ⁽¹⁾

IN	-0.3V to +6V
EN, FLAG, OUT to GND	-0.3V to +6V
Continuous Power Dissipation (T _A = +25°C) ⁽²⁾	
SOIC8.....	1.39W
TSOT23-5.....	0.57W
Junction Temperature	150°C
Lead Temperature	260°C
Storage Temperature.....	-65°C to +150°C
Operating Junct. Temp (T _J).....	-20°C to +125°C

Thermal Resistance ⁽³⁾

	θ_{JA}	θ_{JC}
SOIC8.....	90	42... °C/W
TSOT23-5.....	220	110.. °C/W

Notes:

- Exceeding these ratings may damage the device.
- The maximum allowable power dissipation is a function of the maximum junction temperature T_J (MAX), the junction-to-ambient thermal resistance θ_{JA} , and the ambient temperature T_A. The maximum allowable continuous power dissipation at any ambient temperature is calculated by P_D (MAX) = (T_J (MAX)-T_A)/ θ_{JA} . Exceeding the maximum allowable power dissipation will cause excessive die temperature, and the regulator will go into thermal shutdown. Internal thermal shutdown circuitry protects the device from permanent damage.
- Measured on JESD51-7 4-layer PCB.

ELECTRICAL CHARACTERISTICS ⁽⁴⁾
 $V_{IN}=5V$, $T_A=+25^{\circ}C$, unless otherwise noted.

Parameter	Condition	Min	Typ	Max	Units
IN Voltage Range		2.7		5.5	V
Supply Current	Device Enable, $V_{OUT}=float$	70	90	120	μA
Shutdown Current	Device Disable, $V_{OUT}=float$, $V_{IN}=5.5V$			1	μA
Off Switch Leakage	Device Disable, $V_{IN}=5.5V$			1	μA
Current Limit		550	808	1100	mA
Response time to short circuit	$V_{IN}=5V$		10		μs
Trip Current	Current Ramp (slew rate $\leq 100A/s$) on Output	0.6	1	1.4	A
Under-voltage Lockout	Rising Edge	1.95		2.65	V
Under-voltage Hysteresis			250		mV
FET On Resistance	$I_{OUT}=100mA$ ($-20^{\circ}C \leq T_A \leq +85^{\circ}C$)				m Ω
	SOIC8		90	130	
	TSOT23-5		115	155	
EN Input Logic High Voltage		2			V
EN Input Logic Low Voltage				0.8	V
FLAG Output Logic Low Voltage	$I_{SINK}=5mA$		0.15	0.4	V
FLAG Output High Leakage Current	$V_{IN}=V_{FLAG}=5.5V$			1	μA
Thermal Shutdown			140		$^{\circ}C$
Thermal Shutdown Hysteresis			20		$^{\circ}C$
V_{OUT} Rising Time, T_r ⁽⁵⁾	$V_{IN}=5.5V$, $C_L=1\mu F$, $R_L=11\Omega$ $V_{IN}=2.7V$, $C_L=1\mu F$, $R_L=11\Omega$		0.9 1.7	2 3	ms
V_{OUT} Falling Time, T_f ⁽⁶⁾	$V_{IN}=5.5V$, $C_L=1\mu F$, $R_L=11\Omega$ $V_{IN}=2.7V$, $C_L=1\mu F$, $R_L=11\Omega$			0.5 0.4	ms
Turn On Time, T_{on} ⁽⁷⁾	$C_L=100\mu F$, $R_L=11\Omega$		1.8	3	ms
Turn Off Time, T_{off} ⁽⁸⁾	$C_L=100\mu F$, $R_L=11\Omega$		2.5	10	ms
FLAG Deglitch Time		4	8	15	ms
EN Input Leakage				1	μA
Reverse Leakage Current	$V_{OUT}=5.5V$, $V_{IN}=0$		0.2	1	μA

NOTE:

- 4) Production test at $+25^{\circ}C$. Specifications over the temperature range are guaranteed by design and characterization.
- 5) Measured from 10% to 90%.
- 6) Measured from 90% to 10%.
- 7) Measured from (50%) EN signal to (90%) output signal.
- 8) Measured from (50%) EN signal to (10%) output signal.

PIN FUNCTIONS

SOIC8	TSOT23-5	Name	Description
1	2	GND	Ground.
2, 3	5	IN	Input Voltage. Accepts 2.7V to 5.5V input.
4	4	EN	Enable Input. Active high.
5	3	FLAG	IN-to-OUT Over-current, active-low output flag. Open-Drain.
6, 7, 8	1	OUT	Power-Distribution Switch Output.

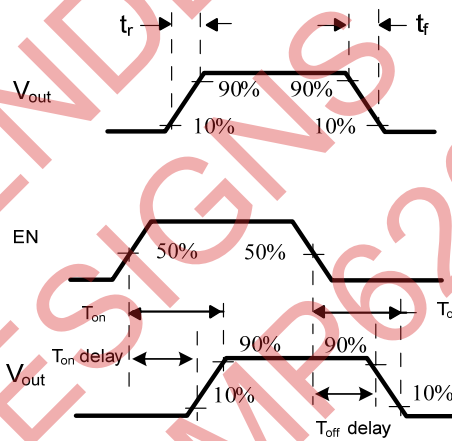
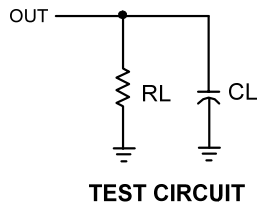
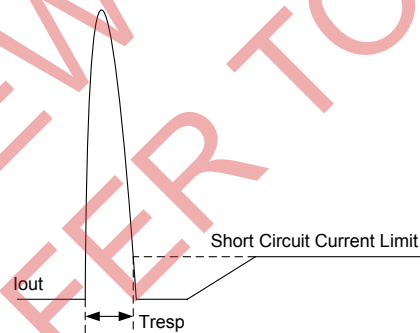
TYPICAL PERFORMANCE CHARACTERISTICS
 $T_A = +25^\circ\text{C}$, unless otherwise noted.

VOLTAGE WAVEFORMS
Figure 1—Test Circuit and Voltage Waveforms

Figure 2—Response Time to Short Circuit Waveform

TYPICAL PERFORMANCE CHARACTERISTICS

$V_{IN}=5V$, $V_{EN} = 5V$, $V_{CC}=5V$, $C_L=2.2\mu F$, $T_A = +25^\circ C$, unless otherwise noted.

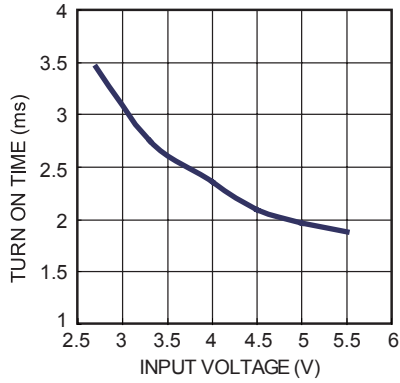
Turn on Time vs. Input Voltage

$R_L=10\Omega$, $C_L=100\mu F$



Turn off Time vs. Input Voltage

$R_L=10\Omega$, $C_L=100\mu F$

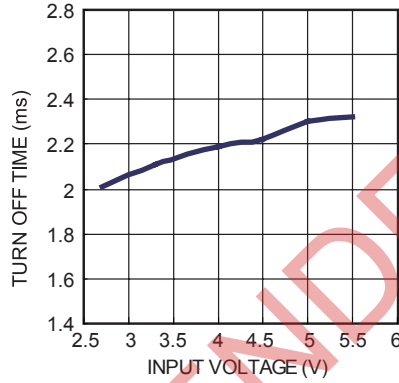

Rise Time vs. Input Voltage

$R_L=10\Omega$

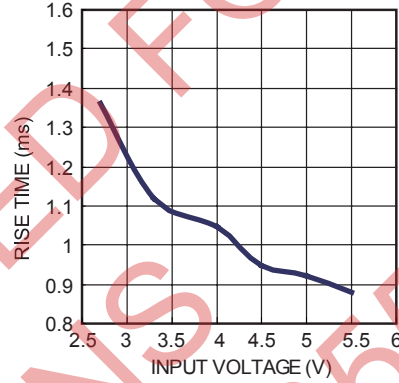

Fall Time vs. Input Voltage

$R_L=10\Omega$

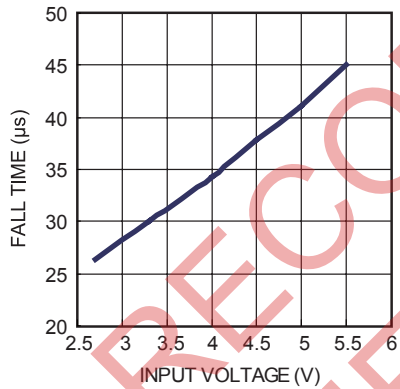

Supply Current vs. Input Voltage

$EN=high$, $Output=float$

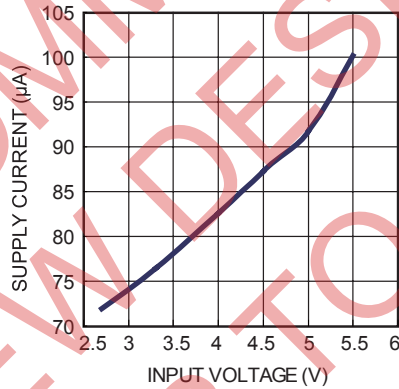

Static Drain-Source On-State Resistance Variation vs. Ambient Temperature

$I_O=0.1A$

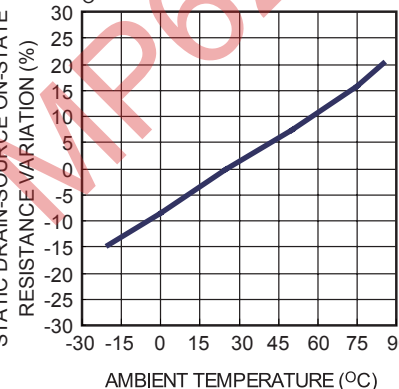

Static Drain-Source On-State Resistance vs. Input Voltage

TSOT23-5 Package, $I_O=0.1A$

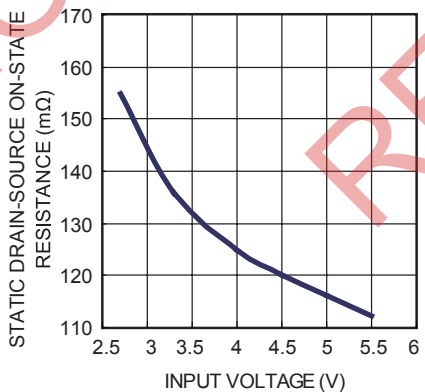

Input to Output Voltage vs. Load Current

TSOT23-5 Package

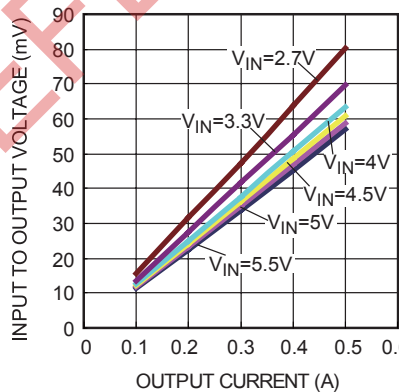

Current Limit vs. Input Voltage

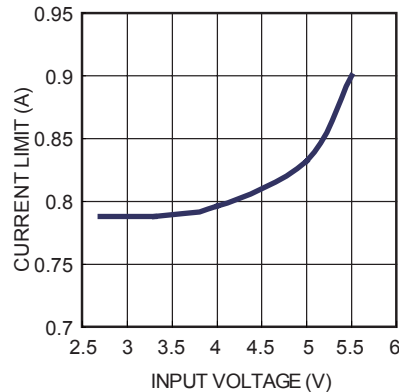

TYPICAL PERFORMANCE CHARACTERISTICS

$V_{IN}=5V$, $V_{EN} = 5V$, $V_{CC}=5V$, $C_L=2.2\mu F$, $T_A = +25^\circ C$, unless otherwise noted.

Threshold Trip Current vs. Input Voltage

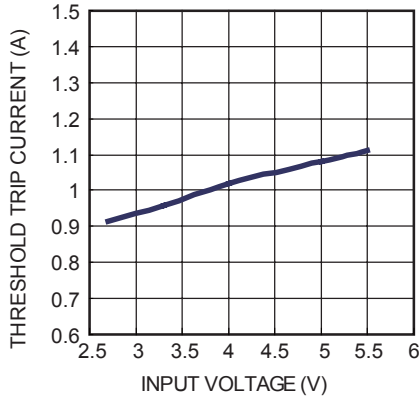

Current Limit Response Time vs. Peak Current

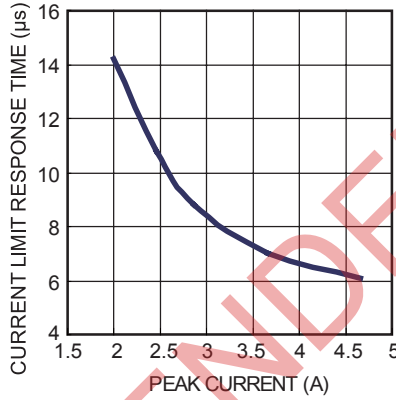

Turn On Time and Rise Time with 2.2µF Load
 $R_L = 10\Omega$

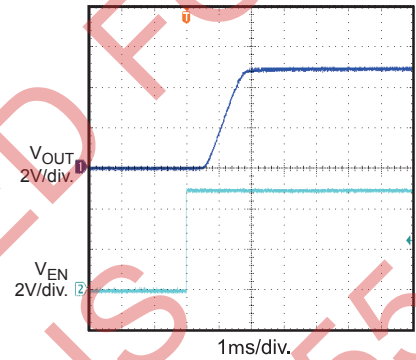

Turn Off Time and Fall Time with 2.2µF Load
 $R_L = 10\Omega$

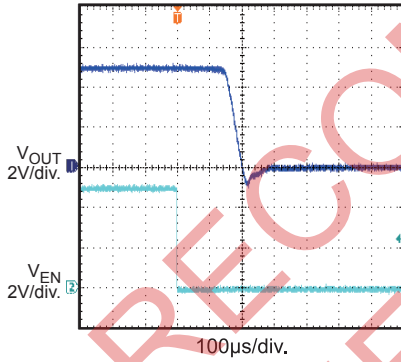

Turn On Time and Rise Time with 100µF Load
 $R_L = 10\Omega$

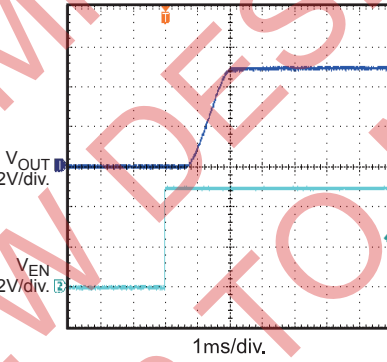

Turn Off Time and Fall Time with 100µF Load
 $R_L = 10\Omega$

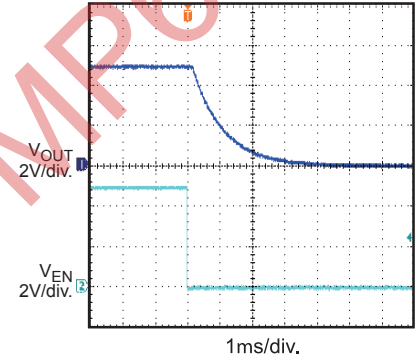

Short the Output then Enable the Device

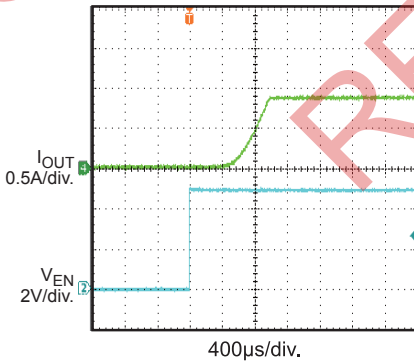

Threshold Trip Current with Ramped Load on Enabled Device

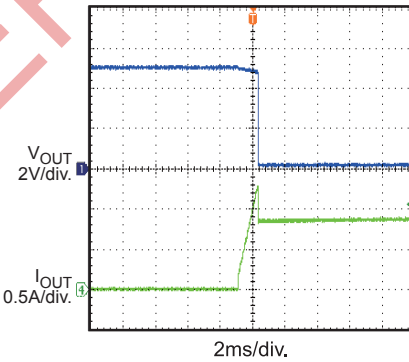

Flag Deglitch when Ramped Load to Current Limit

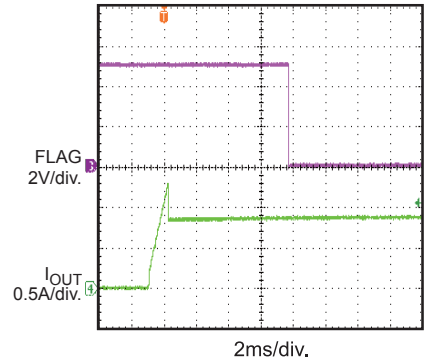

TYPICAL PERFORMANCE CHARACTERISTICS

$V_{IN}=5V$, $V_{EN} = 5V$, $V_{CC}=5V$, $C_L=2.2\mu F$, $T_A = +25^\circ C$, unless otherwise noted.

Input Inrush Current with Different Load Capacitance

$I_O = 0.5A$

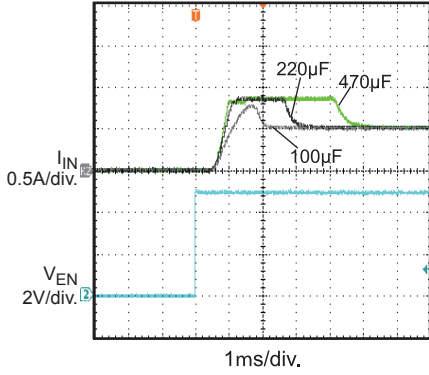

1Ω Load Connected to Enabled Device

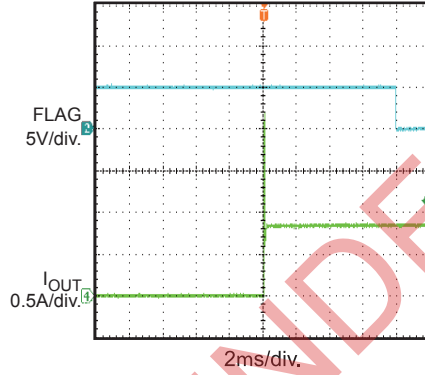

Short Vout to GND

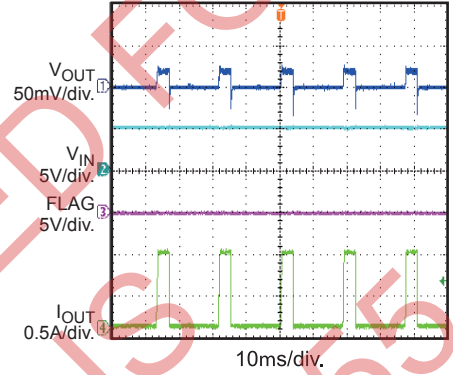

NOT RECOMMENDED FOR NEW DESIGNERS REFER TO MP62055-3

FUNCTION BLOCK DIAGRAM

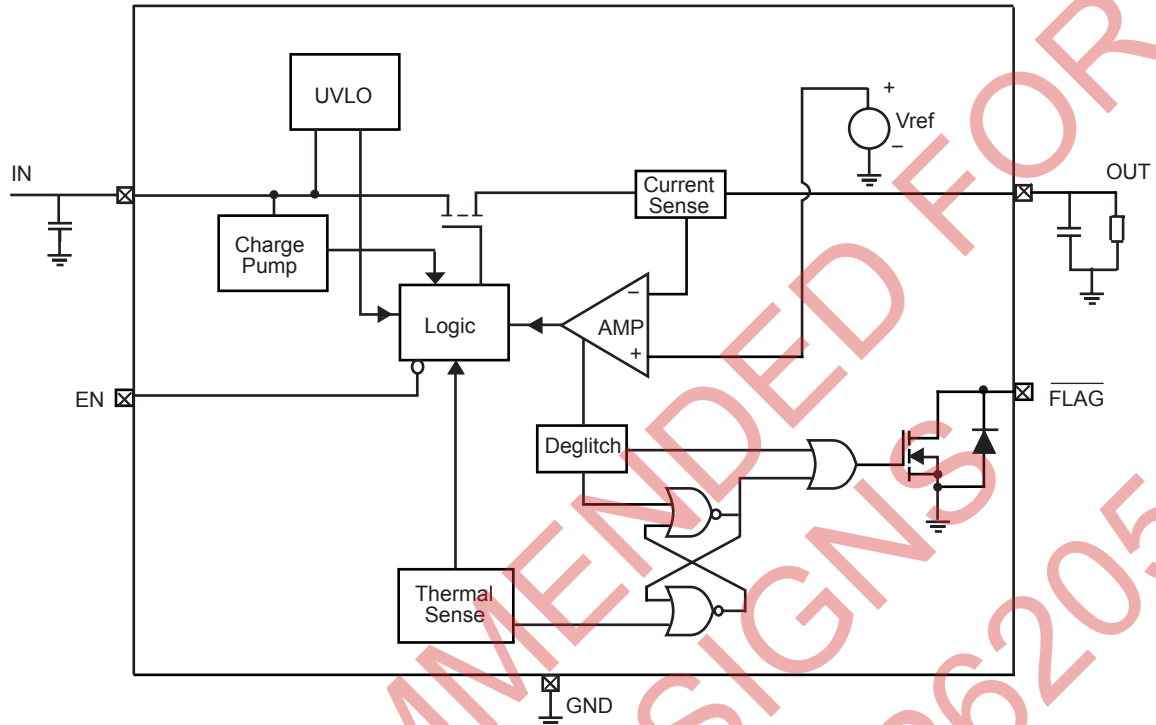

Figure 3—Function Block Diagram

DETAILED DESCRIPTION

Over Current

When the load exceeds trip current (minimum threshold current triggering constant-current mode) or a short is present, MP62055-3 switches into to a constant-current mode (current limit value). MP62055-3 will be shutdown only if the over current condition stays long enough to trigger thermal protection.

Trigger over current protection for different overload conditions occurring in applications:

- 1) The output has been shorted or overloaded before the device is enabled or input applied. MP62055-3 detects the short or overload and immediately switches into a constant-current mode.
- 2) A short or an overload occurs after the device is enabled. After the current-limit circuit has been tripped (reached the trip current threshold), the device switches into constant-current mode. However, high current may flow for a short period of time before the current-limit circuit can react.
- 3) Output current has been gradually increased beyond the recommended operating current. The load current rises until the trip current threshold is reached or until the thermal limit of the device is exceeded. The MP62055-3 is capable of delivering current up to the trip current threshold without damaging the device. Once the trip threshold has been reached, the device switches into its constant-current mode.

Flag Response

The FLAG pin is an open drain configuration. When over current or over temperature is encountered, FLAG will report a fail mode (low level). It remains low until fault condition is removed.

For over temperature, The FLAG is not deglitched. When output is shorted to ground and the device enters to thermal cycle, FLAG will keep low level until the device resumes normal operation.

For over current, 8ms deglitch timeout is needed. This is used to ensure that no false fault signals are reported. This internal deglitch circuit eliminates the need for components.

The FLAG will not change state when the input UVLO is triggered.

Thermal Protection

The purpose of thermal protection is to prevent damage in the IC by allowing excessive current to flow and heating the junction. The die temperature is internally monitored until the thermal limit is reached. Once this temperature is reached, the switch will turn off and allow the chip to cool. The switch has a built-in hysteresis, and would recover once cooling down to approx 120°C.

Under-voltage Lockout (UVLO)

This circuit is used to monitor the input voltage to ensure that the MP62055-3 is operating correctly. This UVLO circuit also ensures that there is no operation until the input voltage reaches the minimum spec.

Enable

The logic pin disables the chip to reduce the supply current. The device will operate once the enable signal reaches logic enable threshold. The input is compatible with both CMOS and TTL.

APPLICATION INFORMATION

Power-Supply Considerations

Over 10 μ F capacitor between IN and GND is recommended. This precaution reduces power-supply transients that may cause ringing on the input and improves the immunity of the device to short-circuit transients.

In order to achieve smaller output load transient ripple, placing a high-value electrolytic capacitor on the output pin(s) is recommended when the load is heavy.

NOT RECOMMENDED FOR
NEW DESIGNS
REFER TO MP62055

PACKAGE INFORMATION

SOIC8

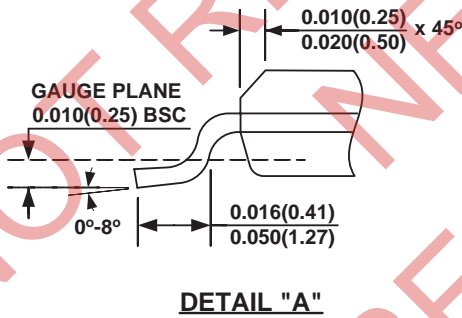
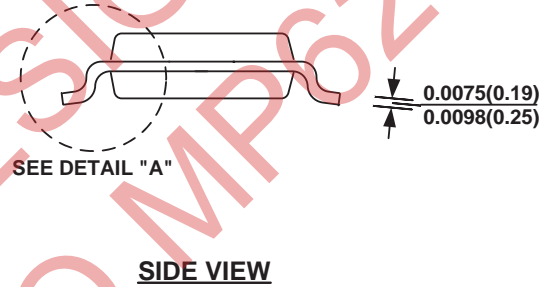
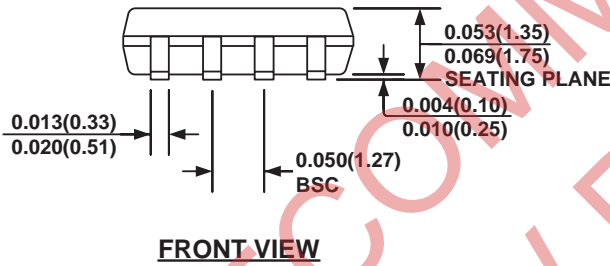
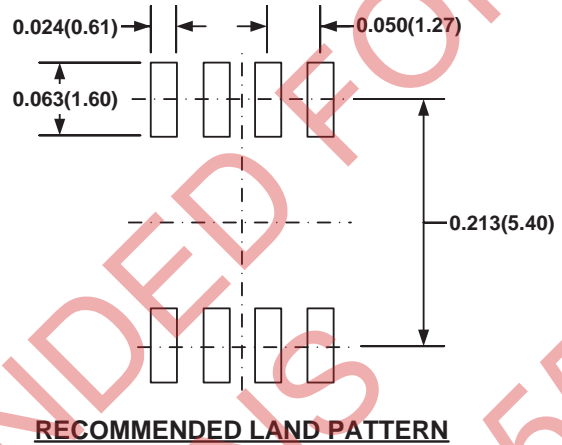
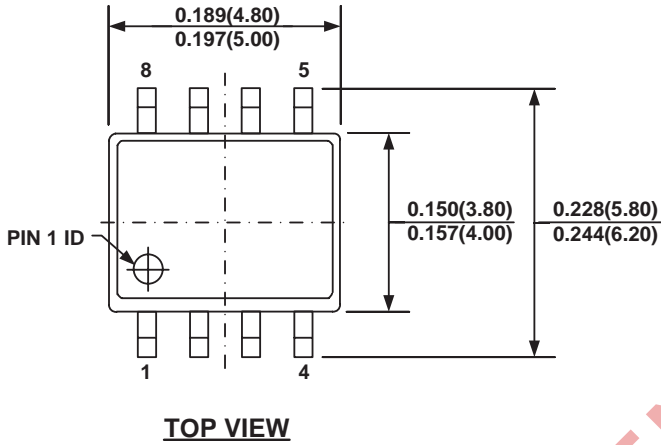

NOTE:

- 1) CONTROL DIMENSION IS IN INCHES. DIMENSION IN BRACKET IS IN MILLIMETERS.
- 2) PACKAGE LENGTH DOES NOT INCLUDE MOLD FLASH, PROTRUSIONS OR GATE BURRS.
- 3) PACKAGE WIDTH DOES NOT INCLUDE INTERLEAD FLASH OR PROTRUSIONS.
- 4) LEAD COPLANARITY (BOTTOM OF LEADS AFTER FORMING) SHALL BE 0.004" INCHES MAX.
- 5) DRAWING CONFORMS TO JEDEC MS-012, VARIATION AA.
- 6) DRAWING IS NOT TO SCALE.

TSOT23-5

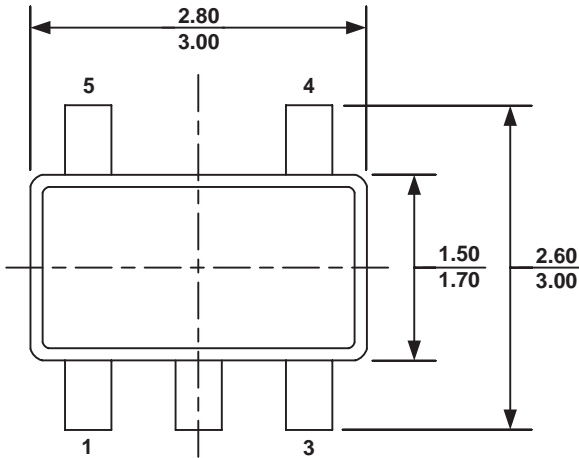

TOP VIEW

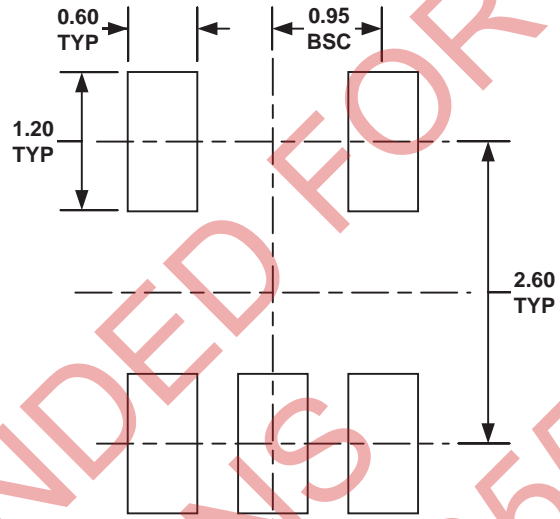

RECOMMENDED LAND PATTERN

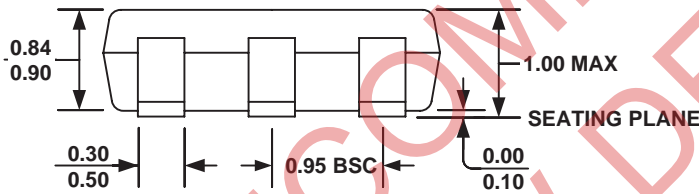

FRONT VIEW

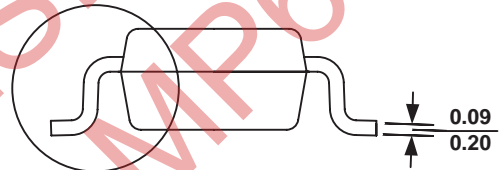

SEE DETAIL "A"

SIDE VIEW

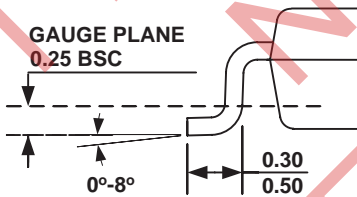

DETAIL A

NOTE:

- 1) ALL DIMENSIONS ARE IN MILLIMETERS.
- 2) PACKAGE LENGTH DOES NOT INCLUDE MOLD FLASH, PROTRUSION OR GATE BURR.
- 3) PACKAGE WIDTH DOES NOT INCLUDE INTERLEAD FLASH OR PROTRUSION.
- 4) LEAD COPLANARITY (BOTTOM OF LEADS AFTER FORMING) SHALL BE 0.10 MILLIMETERS MAX.
- 5) DRAWING CONFORMS TO JEDEC MO-193, VARIATION AA.
- 6) DRAWING IS NOT TO SCALE.

NOTICE: The information in this document is subject to change without notice. Users should warrant and guarantee that third party Intellectual Property rights are not infringed upon when integrating MPS products into any application. MPS will not assume any legal responsibility for any said applications.