



The Future of Analog IC Technology®

MP4013

High-Brightness, High-Current Accuracy WLED Controller

DESCRIPTION

The MP4013 is a current mode controller designed for driving the high brightness Light Emitting Diodes (LEDs) with wide supply voltage 8V-26V. It can be used in Boost, Buck, Buck-boost and SEPIC topologies.

The MP4013 drives external MOSFET with fixed frequency architecture to regulate the LED current, which is measured through an external current sense resistor. The switching frequency can be programmed to meet kinds of applications. The cycle-by-cycle current limit can be programmed by the sense resistor on CS pin.

The MP4013 integrates a 600mV reference voltage for LED current feedback with $\pm 1.2\%$ accuracy. It outputs a 5V reference voltage with $\pm 1\%$ accuracy, which is used as the reference voltage for external circuit.

The MP4013 implements both DC input analog dimming and pulse signal input analog dimming function. The amplitude of the LED current could be controlled either by the level of a DC input signal or by the duty cycle of a pulse signal. The MP4013 also employs fast and deep PWM dimming to the LED current with high dimming ratio.

MP4013 integrates Under-Voltage Lockout, Over Voltage Protection, Over Current Protection, Short LED Protection, Short Output Protection, Short Inductor/diode Protection and OTP. The fault indicator is pulled low in fault condition.

The MP4013 is available in SOIC-16 package.

FEATURES

- Constant-current WLED Driver
- 600mV Feedback Voltage with $\pm 1.2\%$ Accuracy
- 8V-26V Input Voltage
- Programmable Switching Frequency
- Leading Edge Blanking for Current Sense
- High Dimming Ratio Fast DPWM Dimming
- DC Input or Pulse Signal Input Analog Dimming
- 5V Reference Voltage with $\pm 1\%$ Accuracy
- External PWM Dimming MOS Driver
- Programmable Input Bus Voltage UVLO
- Soft Start
- Over Voltage Protection
- Short LED Protection
- Short Output Protection
- Over Current Protection
- Short Inductor/Diode Protection
- Fault Indicator
- VIN UVLO
- Thermal Shutdown
- Available in SOIC-16 package

APPLICATIONS

- LCD Backlighting applications
- DC/DC LED Driver applications
- General Illumination
- Industrial Lighting
- Automotive/ Decorative LED Lighting

All MPS parts are lead-free and adhere to the RoHS directive. For MPS green status, please visit MPS website under Quality Assurance. "MPS" and "The Future of Analog IC Technology" are Registered Trademarks of Monolithic Power Systems, Inc.

TYPICAL APPLICATION

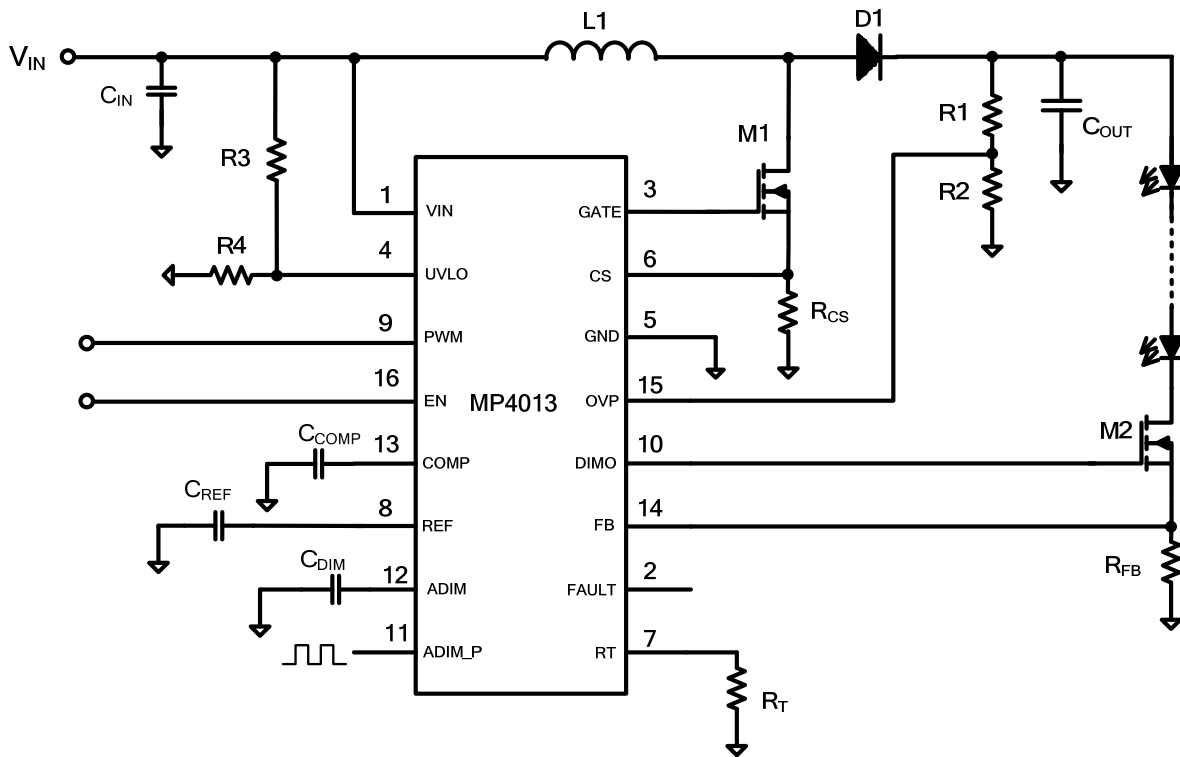

ORDERING INFORMATION

Part Number*	Package	Top Marking
MP4013GS	SOIC-16	<i>See Below</i>

* For Tape & Reel, add suffix -Z (e.g. MP4013GS-Z);

TOP MARKING

MPSYYWW
MP4013
LLLLLLLLLL

MPS: MPS prefix;
YY: year code;
WW: week code;
MP4013: part number;
LLLLLLLLLL: lot number;

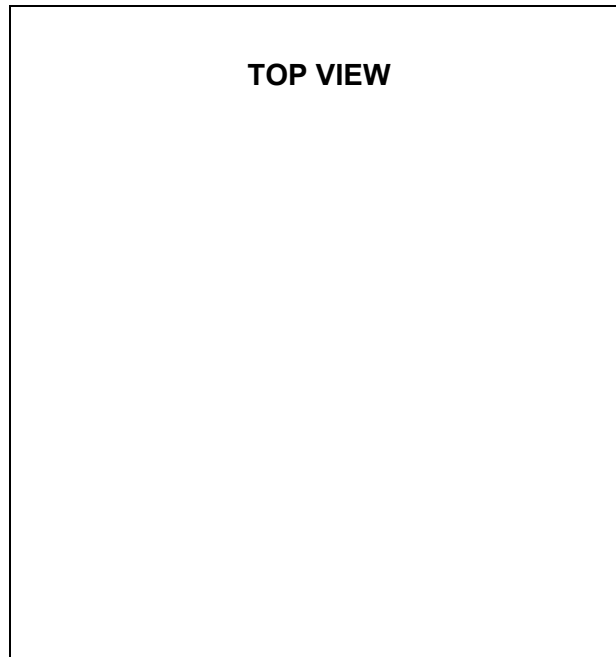
PACKAGE REFERENCE



ABSOLUTE MAXIMUM RATINGS ⁽¹⁾

V _{IN} , V _{EN} , V _{ADIM_P}	-0.3V to 28V
V _{FAULT}	-0.3V to 26V
V _{GATE} , V _{DIMO}	-0.3V to 19V
All Other Pins.....	-0.3V to 6.5V
Junction Temperature.....	150°C
Lead Temperature.....	260°C
Continuous Power Dissipation (T _A = +25°C) ⁽²⁾	
SOIC16.....	1.56 W

Recommended Operating Conditions ⁽³⁾

IN Supply Voltage V _{IN}	8V to 26V
Operating Junction Temp. T _J	-40°C to +125°C

Thermal Resistance ⁽⁴⁾	θ_{JA}	θ_{JC}	
SOIC-16.....	80....	35...	°C/W

Notes:

- 1) Exceeding these ratings may damage the device.
- 2) The maximum allowable power dissipation is a function of the maximum junction temperature T_J (MAX), the junction-to-ambient thermal resistance θ_{JA}, and the ambient temperature T_A. The maximum allowable continuous power dissipation at any ambient temperature is calculated by P_D (MAX) = (T_J (MAX)-T_A)/θ_{JA}. Exceeding the maximum allowable power dissipation will cause excessive die temperature, and the regulator will go into thermal shutdown. Internal thermal shutdown circuitry protects the device from permanent damage.
- 3) The device is not guaranteed to function outside of its operating conditions.
- 4) Measured on JESD51-7, 4-layer PCB.

**ELECTRICAL CHARACTERISTICS** $V_{IN} = 24V$, $T_A = +25^{\circ}C$, unless otherwise noted.

Parameters	Symbol	Condition	Min	Typ	Max	Units
Operating Input Voltage	V_{IN}		7.6		26	V
Supply Current (Quiescent)	I_Q	$V_{FB}=1V$		1.1	1.3	mA
VIN Under Voltage Lockout	$V_{IN-UVLO}$	V_{IN} Rising	6.7	7.1	7.5	V
VIN Under Voltage Lockout Hysteresis	V_{IN-HYS}		320	395	470	mV
Feedback						
FB Feedback Voltage	V_{FB}		593	600	607	mV
FB Input Current	I_{FB}	$V_{FB}=600mV$	-0.1		0.1	μA
Reference						
Reference Voltage	V_{REF}		4.95	5	5.05	V
Reference Line Regulation	$V_{REFLINE}$	0.1 μF bypass capacitor, $I_{REF}=0$ $V_{IN}=8-24V$	0		25	mV
Reference Load Regulation	$V_{REFLOAD}$	0.1 μF bypass capacitor, $I_{REF}=0-500\mu A$	0		50	mV
UVLO						
UVLO Threshold	V_{UVLO}	UVLO Rising	2.25	2.37	2.49	V
UVLO Hysteresis	$V_{UVLO-HYS}$		110	160	210	mV
UVLO pin Leakage Current	I_{UVLO}		-1		1	μA
Oscillator						
Oscillator Frequency	f_{OSC1}	$R_T=100k\Omega$	510	590	670	kHz
Oscillator Frequency	f_{OSC2}	$R_T=499k\Omega$	112	130	148	kHz
Maximum Duty Cycle	D_{MAX}	$R_T=499k\Omega$	95	97.5		%
GATE						
GATE High Threshold	V_{GATE}		12	13	13.8	V
GATE Output Rise Time	T_{RISE}	$C_{GATE}=1nF$		40		ns
GATE Output Fall Time	T_{FALL}	$C_{GATE}=1nF$		40		ns
GATE Source Current ⁽⁵⁾	$I_{GATE-SO}$	$V_{GATE}=0V$		1.5		A
GATE Sink Current ⁽⁵⁾	$I_{GATE-SI}$	$V_{GATE}=13V$		0.7		A
Enable						
EN High Threshold	V_{EN-HI}	V_{EN} Rising	1.5			V
EN Low Threshold	V_{EN-LO}	V_{EN} Falling			0.8	V
EN Input Current	I_{EN}	$V_{EN}=3.3V$		3	4	μA
PWM Dimming						
PWM High Threshold	V_{PWM-HI}	V_{PMW} Rising	1.5			V
PWM Low Threshold	V_{PWM-LO}	V_{PMW} Falling			0.8	V
PWM Pull-down Resistance	R_{PWM}			1		$M\Omega$

**ELECTRICAL CHARACTERISTICS** (continued) $V_{IN}=24V$, $T_A = +25^{\circ}C$, unless otherwise noted.

Parameters	Symbol	Condition	Min	Typ	Max	Units
DIMO						
DIMO High Threshold	V_{DIMO}	$V_{IN}=24V$	12.8	13.3	13.8	V
DIMO Source Current ⁽⁵⁾	$I_{DIMO-SO}$	$V_{DIMO}=0V$		0.1		A
DIMO Sink Current ⁽⁵⁾	$I_{DIMO-SI}$	$V_{DIMO}=13V$		0.2		A
Analog Dimming						
Maximum Analog Dimming Threshold	V_{ADMAX}		2.25	2.34	2.43	V
Dimming Linearity	V_{FB_ADIM}	$V_{ADIM}=24mV$		9.8		mV
		$V_{ADIM}=100mV$		28.4		mV
		$V_{ADIM}=240mV$		63.3		mV
		$V_{ADIM}=480mV$		123.3		mV
		$V_{ADIM}=720mV$		183.3		mV
ADIM_P High Threshold	V_{ADIM_PHI}		1.5			V
ADIM_P Low Threshold	V_{ADIM_PLO}				0.8	V
ADIM_P Pull Down Resistor	R_{ADIM_P}			1		MΩ
ADIM_P Floating (when the voltage high than this level, IC take it as no pulse signal applied)	V_{ADIM_PF}		6	6.45	6.9	V
Current Sense						
Current Limit Value	V_{CL}	Duty=0	435	485	535	mV
OCP Detect Voltage	V_{OCP}	Over Current Protection		490		mV
Leading Edge Blanking Time	T_{BLANK}		100	180	250	ns
Compensation						
Transconductance of Error Amplifier	G_{EA}		280	370	460	$\mu A/V$
Maximum Sourcing/Sinking Current	I_{EA}			80		μA
Soft Start Current	I_{SS}	$V_{FB}<0.8 \cdot I_{REF}$	15	22	30	μA
Time for COMP Saturated Protection Detection	T_{COMP}			2048		cycle
Over Voltage Protection						
OVP Threshold	V_{OVP-TH}		4.9	5	5.1	V
OVP Threshold Hysteresis	$V_{OVP-HYS}$			440		mV
SCP Protection Threshold	$V_{OVP-SCP}$		250	300	350	mV
Output Short Protection						
FB Short Protection Threshold			1.15	1.22	1.29	V
Propagation time for short circuit detection	T_{OFF}	FB=1.3V, FAULT goes form high to low		1.4	2	μs
Thermal Shutdown ⁽⁵⁾				160		$^{\circ}C$

Notes:

5) Guaranteed by design

TYPICAL PERFORMANCE CHARACTERISTICS

VIN=24V, Otherwise noticed.

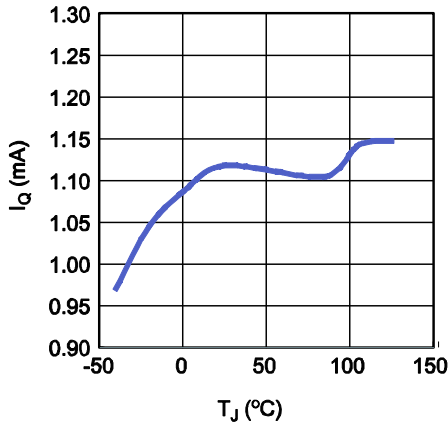
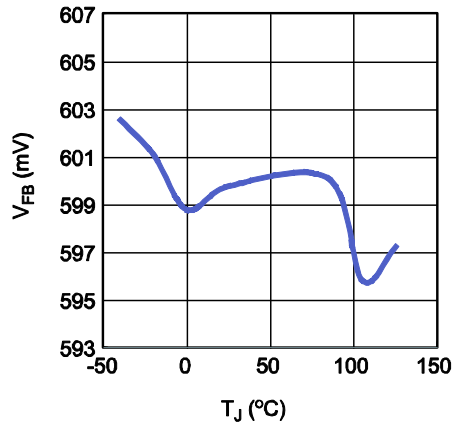
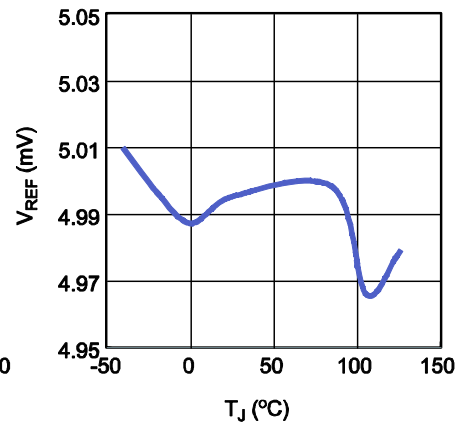
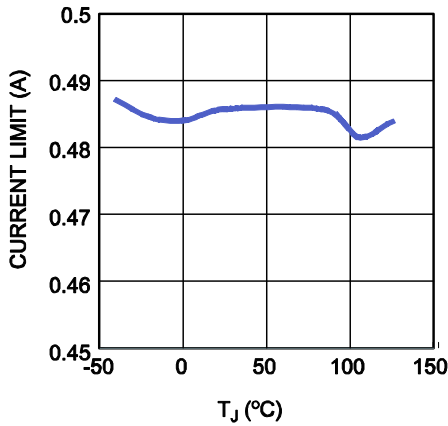
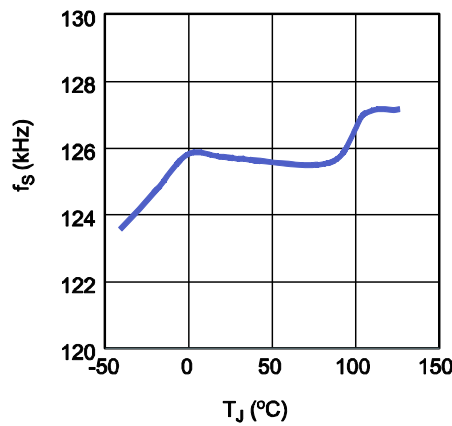
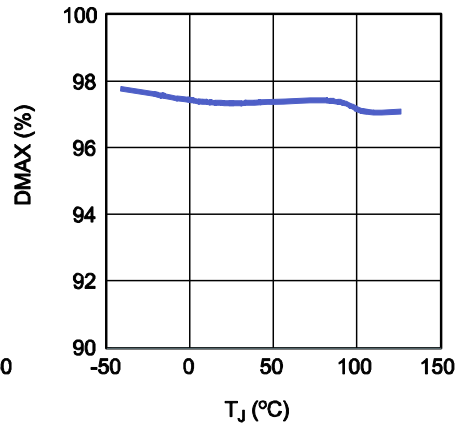
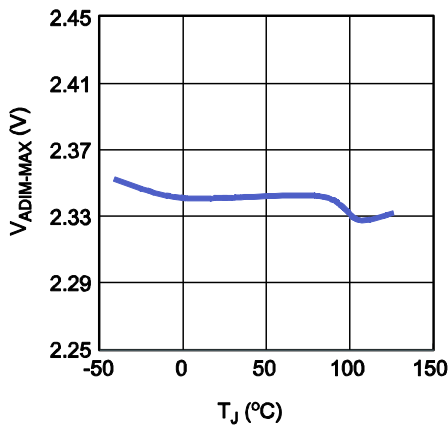
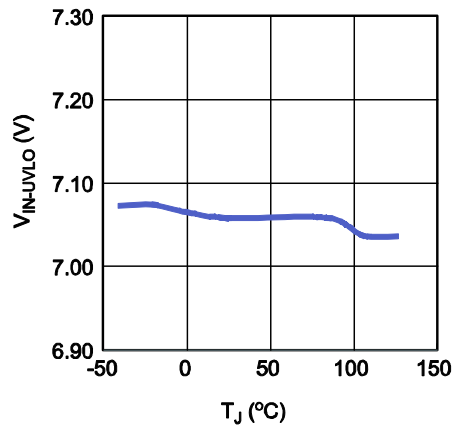
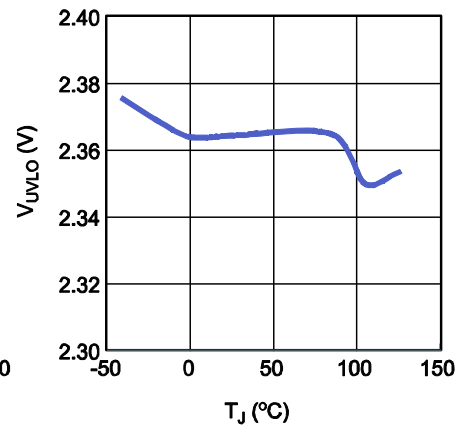
Quiescent Current vs. T_J

FB Voltage vs. T_J

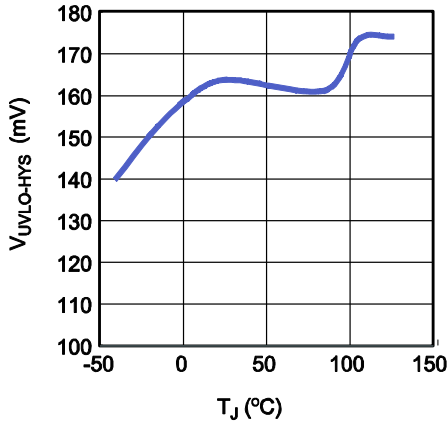
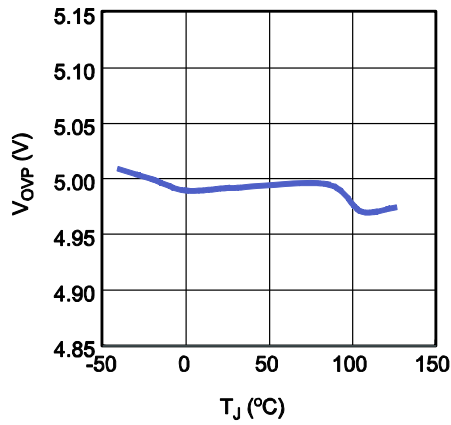
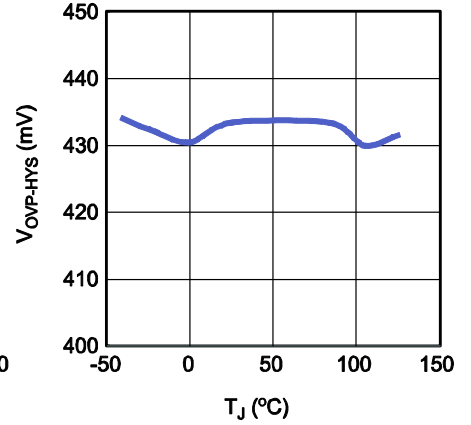
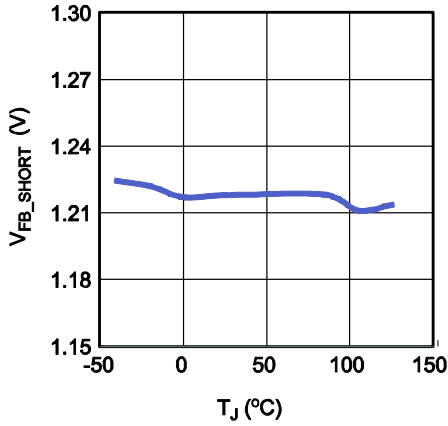
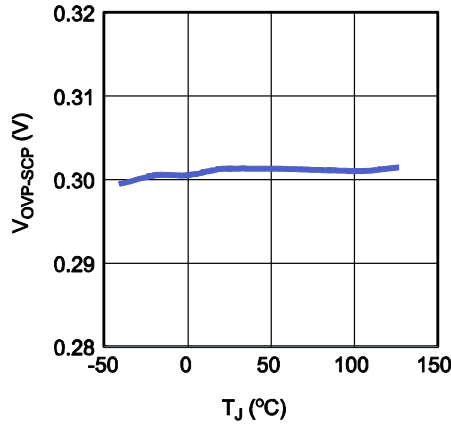
Reference Voltage vs. T_J

Current Limit Threshold vs. T_J

Switch Frequency vs. T_J
 R_T=499kΩ

Maximum Duty vs. T_J
 R_T=499kΩ

Analog Dimming High Threshold vs. T_J

VIN UVLO Rising Threshld vs. T_J

UVLO Rising Threshold vs. T_J

TYPICAL PERFORMANCE CHARACTERISTICS

VIN=24V, Otherwise noticed.

UVLO Hysteresis vs. T_J

OVP Rising Threshold vs. T_J

OVP Hysteresis vs. T_J

FB Short Protection Threshold vs. T_J

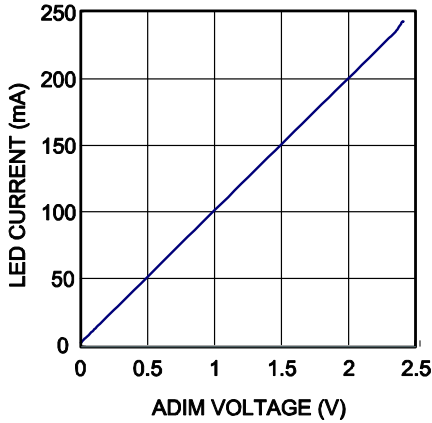
SCP Threshold vs. T_J

TYPICAL PERFORMANCE CHARACTERISTICS

P_{VIN} (bus voltage)=36V, V_{IN} (IC supply)=12V, V_{LED} =150V, I_{LED} =240mA, f_s =100kHz, L =330 μ H. Otherwise noticed.

DC-input Analog Dimming Curve



Pulse-Input Analog Dimming

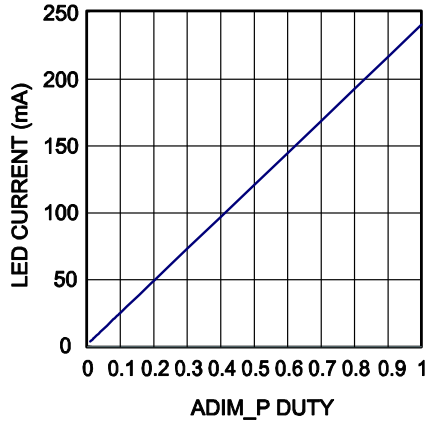

PWM Dimming Curve

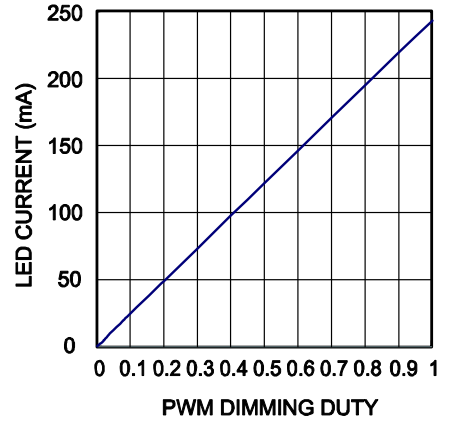

Efficiency vs. Input Voltage

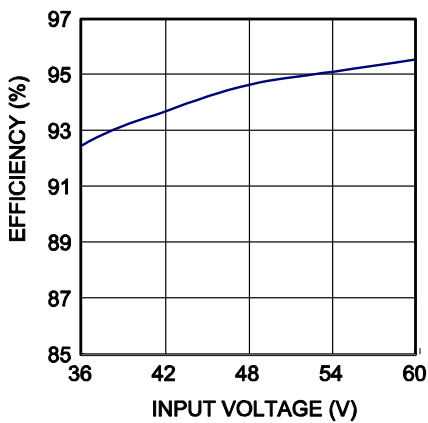

Efficiency vs. LED Voltage

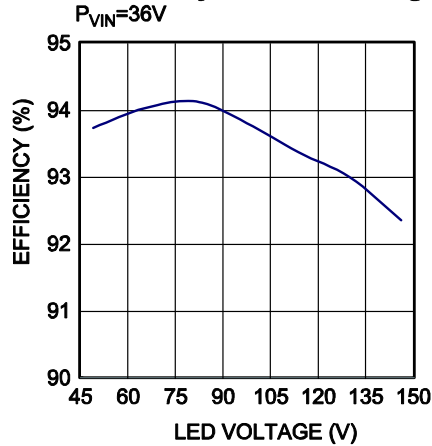

TYPICAL PERFORMANCE CHARACTERISTICS

P_{VIN} (bus voltage)=36V, V_{IN} (IC supply)=12V, V_{LED} =150V, I_{LED} =240mA, f_s =118kHz, L =330 μ H. Otherwise noticed.

Steady State

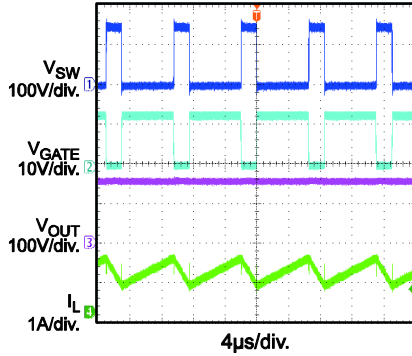

EN On

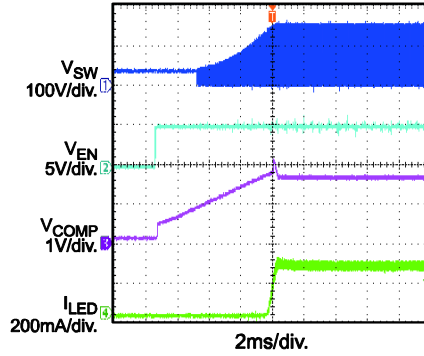

EN Off

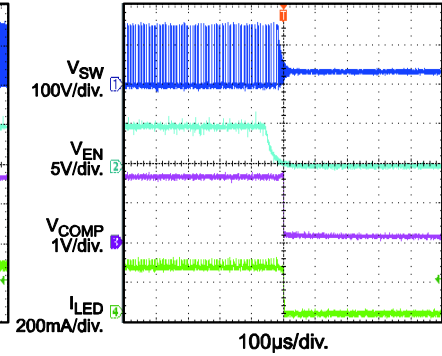

PWM Dimming
 f_{PWM} =200Hz

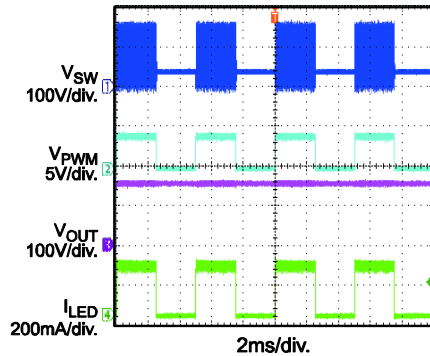

DC input Analog Dimming

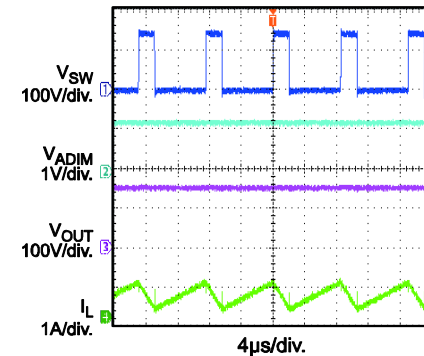

Pulse-input Analog Dimming

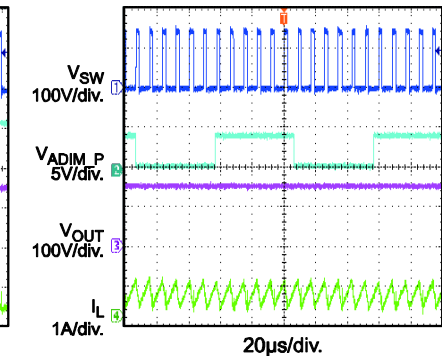

OVP

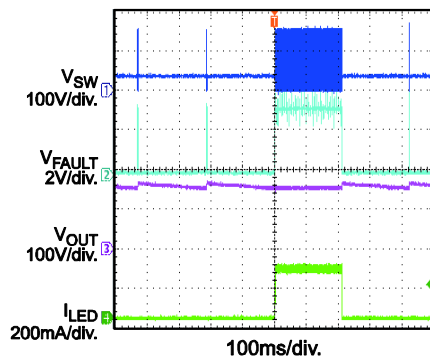

SLP

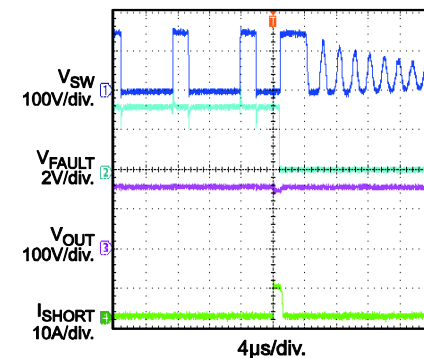

Short LED- to GND

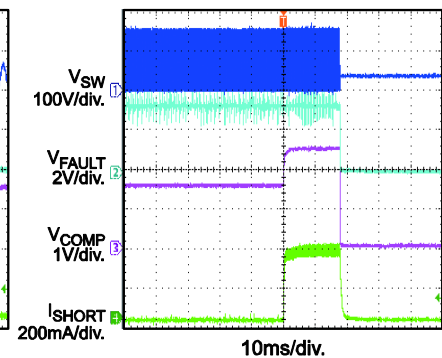

TYPICAL PERFORMANCE CHARACTERISTICS

P_{VIN} (bus voltage)=36V, V_{IN} (IC supply)=12V, V_{LED} =150V, I_{LED} =240mA, f_s =100kHz, L =330 μ H. Otherwise noticed.

Short Inductor

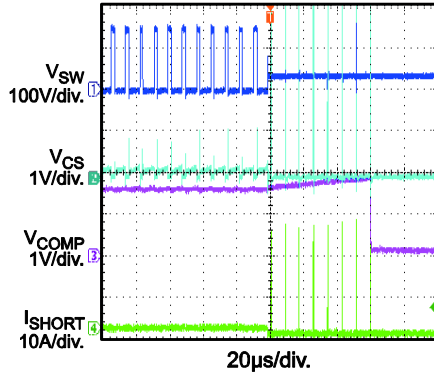

Short Diode

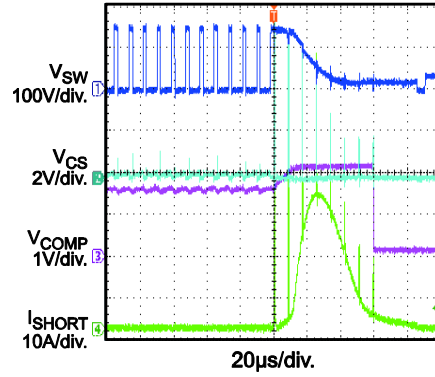

Short to GND

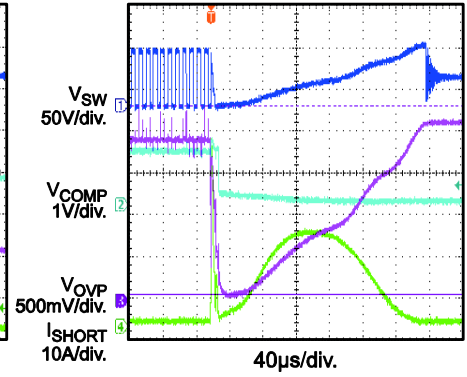

PIN FUNCTIONS

Pin #	Name	Pin Function
1	VIN	Input Supply Pin, 8-26V. It is the input of internal linear regulator. Must be locally bypassed.
2	FAULT	Fault Indication Output Pin, open drain. FAULT is high-Z during normal operation, and pulled to GND when fault is triggered.
3	GATE	External MOSFET Gate Driver Pin.
4	UVLO	Input Voltage Bus UVLO Pin. A voltage higher than UVLO threshold (2.37V) to enable IC.
5	GND	Ground.
6	CS	Switch Current Sense Input Pin. It is used to sense the current of the external power FET. It integrates a built-in blanking time to avoid switching noise interruption.
7	RT	Switching frequency set Pin. A resistor connected between this pin and GND sets the frequency.
8	REF	Reference Output Pin. 5V reference voltage with $\pm 1\%$ accuracy. Must be locally bypassed.
9	PWM	PWM Dimming Input Pin. Apply a PWM signal on this pin for brightness control. The GATE and DIMO are disabled when PWM signal is low. The GATE and DIMO are enabled when PWM signal is high.
10	DIMO	External Dimming MOS Driving Signal Pin. This pin is pulled down to GND when the PWM signal is Low, or the protection is triggered.
11	ADIM_P	Pulse signal Input Analog Dimming Input Pin. Apply a high-frequency pulse signal on this pin while doing pulse signal input analog dimming.
12	ADIM	Analog Dimming Input Pin. Apply a DC voltage from 0 to 2.34V to adjust the amplitude of LED current from minimum to full scale to implement the DC analog dimming function. Place a capacitor on this pin while doing pulse signal input analog dimming. Keep the voltage of this pin higher than 2.4V when analog dimming is not required.
13	COMP	Compensation Pin. This pin is used to compensate the regulation control loop. Connect a capacitor or a series RC network from COMP to GND. COMP pin is also used for soft start. At IC start up, the internal error sourcing/sinking capacitor is 1/4 times of normal current capacity until the output current reaches 80% of setting current.
14	FB	Feedback Input Pin. 600mV internal feedback voltage. Connect a current sense resistor from FB to GND. The FB voltage is higher than 1.22V for 1us, the short load protection is triggered, and IC latch off.
15	OVP	Over Voltage Protection Input Pin. Connect a resistor divider from output to this pin to program the OVP threshold. When the voltage of this pin reaches 5V, the MP4013 triggers over voltage protection.
16	EN/SYNC	Enable/Switching frequency Synchronization Pin. A high level to enable the IC. Apply a high frequency (>30kHz) pulse signal on this pin, the switching frequency can be synchronized.

OPERATION

MP4013 drives external MOSFET with current mode architecture to regulate the LED current, which is measured through an external current sense resistor.

MP4013 employs a special circuit for regulating the internal power supply, which covers a wide input voltage from 8V to 26V. MP4013 has a 5V reference with $\pm 1\%$ accuracy, which is used as the reference of external circuit.

The switching frequency of MP4013 can be programmed through the resistor between RT pin and GND to meet variable specifications.

The slope compensation is integrated to avoid sub harmonic resonant when duty cycle is greater than 0.5. The cycle-by-cycle current limit can be programmed by the sense resistor on CS pin.

MP4013 implements both DC input analog dimming and pulse signal input analog dimming.

MP4013 integrates Under-Voltage Lockout, Over Voltage Protection, Over Current Protection, Short LED protection, Short Circuit Protection, Short Inductor/diode Protection and OTP.

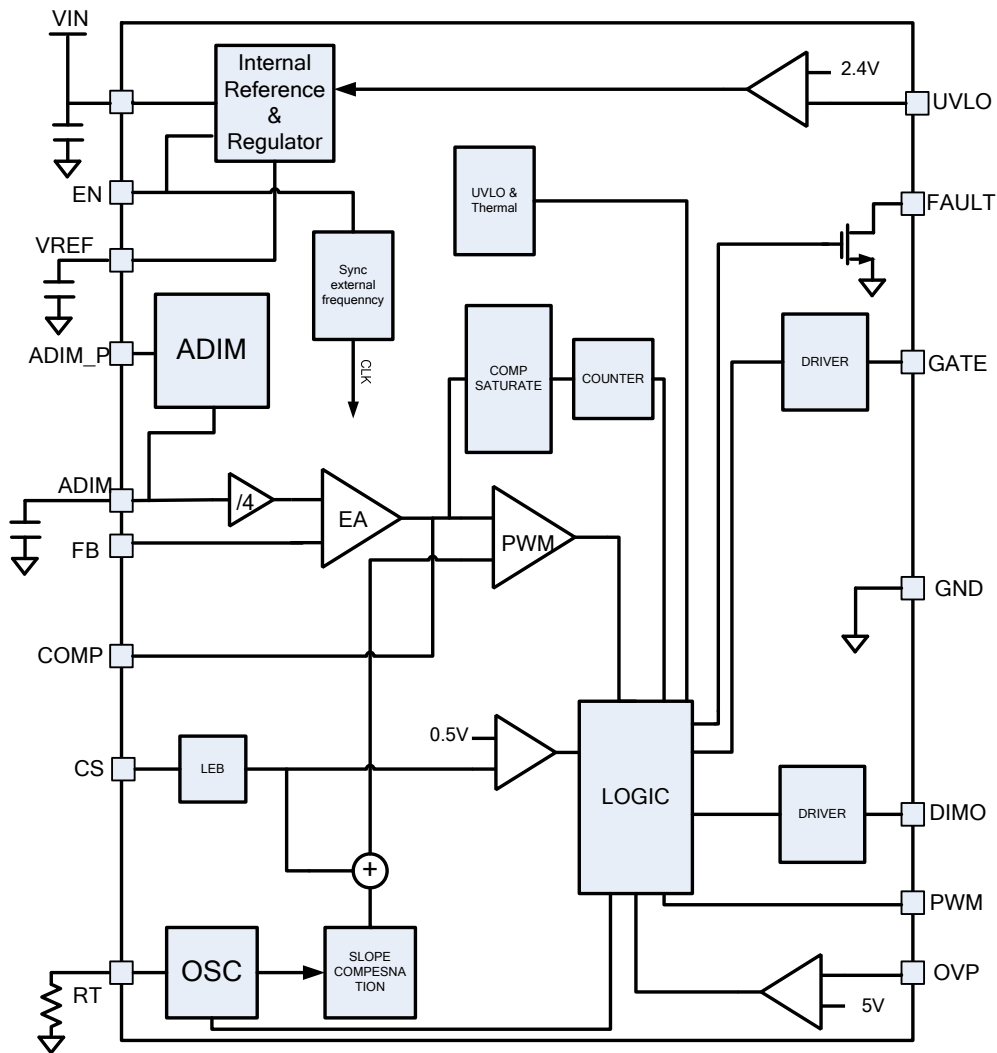

Figure 1: Functional Block of MP4013

Soft Start

MP4013 implements soft start by limiting the current capability of the internal error amplifier when startup. The COMP is firstly jump to its clamp voltage (~0.3V), and then the sourcing/sinking current of the internal error amplifier is limited to charge up external COMP capacitor when the output current is lower than 0.8 of the setting value to achieve the soft start.

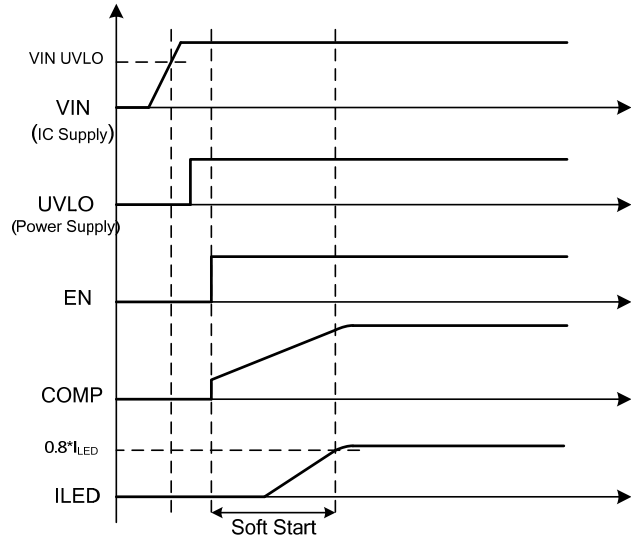

Figure 2: Soft Start Process

Analog Dimming

MP4013 implements DC input analog dimming and pulse signal input analog dimming.

For DC input analog dimming, apply a DC voltage from 0-2.34V on ADIM pin to linearly adjust internal LED current reference voltage from minimum to the maximum value.

For pulse signal input analog dimming, place a capacitor on the ADIM pin and apply a pulse signal (>10 kHz recommended) on ADIM_P pin. This external pulse signal is adjusted internally and forms an internal pulse signal with the same duty and internal reference amplitude. Through an R-C filter, the average voltage of this internal pulse signal is gotten on ADIM pin. Adjust the duty cycle of the pulse signal on ADIM_P to adjust the voltage on ADIM pin and realize the pulse signal input analog dimming.

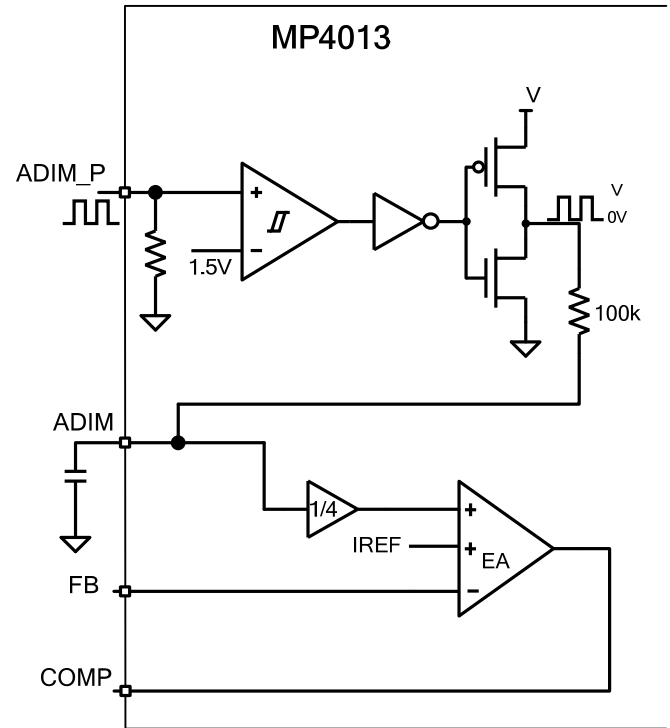

Figure 3: Analog Dimming Functional Block

PWM Dimming

PWM dimming can be achieved by applying a PWM signal on PWM pin. When the PWM signal is high, the GATE and DIMO outputs are enabled, and the output of the internal error amplifier is connected to the external compensation network. So the LED current is regulated accurately. When the PWM signal goes low, the GATE signal is disabled, and the DIMO pin is pulled down to GND to turn off the external dimming MOSFET. Meanwhile, the output of the internal EA is disconnected from the compensation network. Thus, the COMP voltage will be held by the external capacitor. And the dimming MOSFET can prevent the output voltage from being discharged, which helps to achieve the high-speed and deep-ratio PWM dimming with better linear dimming performance.

To avoid the LED flicker in small ratio PWM dimming such as 0.1% PWM dimming duty, the oscillator is synchronized by the PWM dimming signal.

Protection

MP4013 includes Under-Voltage Lockout, Over Voltage Protection, Short Load Protection, Short Circuit Protection, Over Current Protection and Short Inductor/diode Protection. If the fault conditions are detected, the Gate, DIMO, COMP and Fault pins are pulled down.

A Under Voltage Lockout

MP4013 integrates VIN UVLO. The internal circuit does not work until the VIN voltage reaches 7.1V. The hysteresis of VIN UVLO is 395mV.

B. Over Voltage Protection

The Over Voltage Protection is detected by the voltage of OVP pin. When the OVP voltage rise to its high threshold, the over voltage protection is triggered. The GATE, DIMO, COMP and Fault pin are pulled down. After the OVP voltage decreases to its low threshold, the IC tries to recover.

C. Short Load Protection

In short load condition, a large short current will be detected by FB sense resistor. If the FB sensed voltage is higher than 1.22V for 1us, the Short Load Protection is triggered, IC latch off, and FAULT pin pulls to low.

D. Short Circuit Protection

When short circuit at normal operation, the output voltage is pulled low and no current is sensed on FB pin. If the conditions $OVP < 300mV$, $FB < 0.3 \times I_{REF}$, $COMP > 1V$ are satisfied, the protection is triggered and IC latch off.

Fig 5 shows another circuit for the short circuit protection. It uses a PMOS for PWM dimming and also for short circuit protection. When LED+ is shorted to GND, the MP4013 disables the output of DIMO, and the PMOS is disconnected.

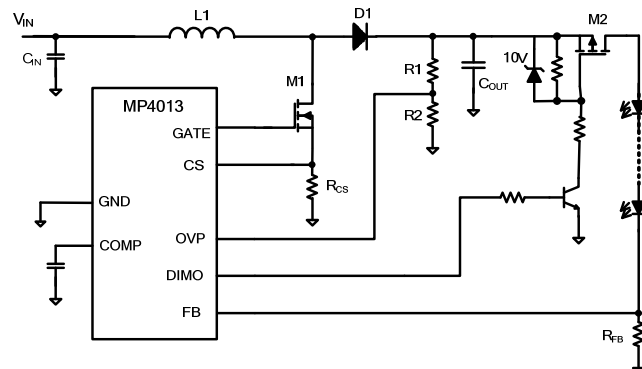

Figure 4: Short Circuit Protection Scheme

E. Over Current Protection (Short Inductor/ Diode Protection)

MP4013 implements cycle-by-cycle current limit function for protection. In normal operation caused by over load and lower input voltage, the over current protection can be recoverable.

In some unexpected cases, like inductor or diode short cases, when the voltage of CS pin which is detected by external CS sense resistor hits latch off current limit value within mini-on time (around 300ns) for 7 consecutive cycles, the Over Current Protection is triggered, IC latch off.

F. LED- to GND Short Protection

In LED- to GND short condition, FB pin sense no current that makes the COMP charge to its saturated value. When COMP keeps saturated for 2048 switching cycles and FB is below 30% of internal IREF, protection is triggered, IC latches off.

APPLICATION INFORMATION

LED Current Setting

The LED current is set by LED current sense resistor (R_{FB}).

$$R_{FB} = \frac{600\text{mV}}{I_{LED}}$$

Switching Frequency Setting

The switching frequency is set by an external frequency resistor on RT pin.

$$R_T(\text{k}\Omega) = \frac{6.8 \times 10^4}{f_s(\text{kHz})} - 15.6$$

Set switching frequency to 100 kHz, a 664kOhm resistor is needed.

Selecting Inductor

Select the inductor to make the circuit work in CCM (Continuous Conduction Mode).

$$L = \frac{V_{IN} \times (V_O - V_{IN})}{V_O \times \Delta I_L \times f_s}$$

Where, ΔI_L is the peak-to-peak current of inductor current. Design the ΔI_L 30% to 60% of inductor average current.

$$I_{L_AVG} = \frac{V_O \times I_{LED}}{V_{IN}}$$

Make sure the inductor saturated current is greater than the inductor peak current.

$$I_{L_PK} = I_{L_AVG} + \frac{1}{2} \Delta I_L$$

Current Sense Resistor Setting

The cycle-by cycle current limit and slope compensation are both integrated. The current limit value can be programmed by the external CS resistor which connects from CS pin to GND. The maximum value of CS sense resistor can be set as follow:

$$R_{CS_max}(\Omega) = \frac{0.435 - 0.27 \times D}{I_{L_pk}}$$

The D is duty cycle of GATE signal, in CCM,

$$D = 1 - \frac{V_{IN}}{V_O}$$

The I_{L_PK} is the peak current of inductor. The slope compensation is integrated to avoid sub-

harmonic resonant when duty is larger than 0.5 in CCM. The following must be satisfied.

$$R_{CS}(\Omega) \leq 5.4 \times \frac{L(\mu\text{H}) \times f_s(\text{kHz})}{V_L(\text{V})} \times 10^{-4}$$

Over Voltage Protection Setting

Choose a voltage divider (R_1 , R_2 in typical application) to set the over voltage protection threshold:

$$V_{OVP} = 5V \times \frac{R_1 + R_2}{R_2}$$

Normally set the OVP point 10%-20% higher than normal operation output voltage.

Bus Voltage UVLO Setting

Choose a voltage divider (R_3 , R_4 in typical application) to set the Input Bus Voltage UVLO point

$$V_{UVLO} = 2.37V \times \frac{R_3 + R_4}{R_3}$$

Normally, set the Bus voltage UVLO point about 10%-20% lower than minimum input bus voltage.

Selecting MOSFET and Diode

There are 2 MOSFET for MP4013 applications. One is for boost converter, the power MOSFET; and the other is for PWM dimming, the dimming MOS.

Choose the power MOS with voltage rating at least 20% higher than OVP voltage to ensure the safety in all condition. The RMS current of the MOSFET can be calculated as follow.

$$I_{RMS} = \sqrt{D \times (I_{L_AVG}^2 + \frac{1}{12} \Delta I_L^2)}$$

Choose the dimming MOS with the voltage rating 20% higher than OVP voltage for 20% safety margin, and the current rating is about 3-5 of LED current.

Choose the diode with voltage rating greater than OVP point, at least 20% higher than OVP point, and the current rating greater than LED current.

Selecting Input Capacitor

The input capacitor reduces the surge current drawn from the input supply and switching noise from the device. Use ceramic capacitor with X7R dielectrics with low ESR and small temperature coefficients.

Select a capacitor to limit the input voltage ripple ΔV_{IN} to less than 5% to 10% of its DC value.

$$C_{IN} \geq \frac{\Delta I_L}{8 \times \Delta V_{IN} \times f_s}$$

Selecting Output Capacitor

The output capacitor limits the output voltage ripple ΔV_O (normally less than 1% to 5% of its DC value), and ensure feedback loop stability.

$$C_{OUT} \geq \frac{I_{LED} \times (V_O - V_{IN})}{\Delta V_O \times f_s \times V_O}$$

Compensation Network Setting

The MP4013 implements peak-current-mode control to regulate the LED current through a compensation network on COMP pin. Usually a RCC network is adopted for most applications, as showing in Figure 5.

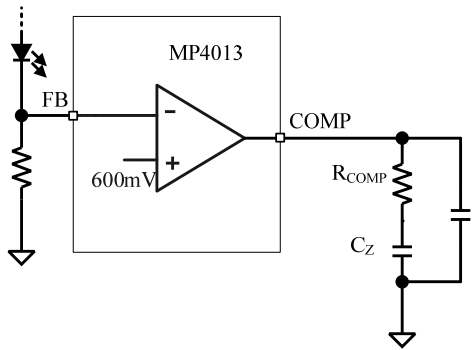

Figure 5: Compensation Network

The transfer function of the compensation network is (assume $C_Z \gg C_P$):

$$EA(s) \approx \frac{G_{EA} \times R_{FB}}{R_{FB} + R_{LED_AC}} \times \frac{1}{s \times C_Z} \times \frac{1 + s \times C_Z \times R_{COMP}}{1 + s \times C_P \times R_{COMP}}$$

Where, G_{EA} is the transconductance of internal error amplifier. $G_{EA}=370\mu A/V$. R_{LED_AC} is the dynamic resistor of LED load, which can be gotten from

$$R_{LED_AC} = \frac{\Delta V_{LED}}{\Delta I_{LED}}$$

The zero of compensation network is

$$f_{z_EA} = \frac{1}{2\pi \times C_Z \times R_{COMP}}$$

The pole of this compensation network is

$$f_{p_EA} = \frac{1}{2\pi \times C_P \times R_{COMP}}$$

The power stage of boost converter is

$$f_{p_PS} = \frac{1}{2\pi \times \left(\frac{V_O}{I_{LED}} \parallel (R_{LED_AC} + R_{FB})\right) \times C_{OUT}}$$

Where, V_O is output voltage, I_{LED} is LED current, C_{OUT} is output capacitance. The right-half-plane (RHP) zero of boost converter stage is:

$$f_{RHP_Z} = \frac{(1-D)^2 \times \frac{V_O}{I_{LED}}}{2\pi \times L}$$

Choose the cross frequency f_c below 1/3 of f_{RHP_Z} to get the R_{COMP} value as follow.

$$R_{COMP} = \frac{R_{LED_AC} + R_{FB}}{R_{FB}} \times \frac{f_c \times C_{OUT} \times 2\pi}{G_{EA} \times (1-D) \times G_{CS}}$$

Where, G_{CS} is conductance of CS circuit.

The zero of the compensation network is to compensate the power-stage pole.

$$C_Z = \frac{1}{2\pi \times f_{PS_P} \times R_{COMP}}$$

The pole of the compensation network is to compensate the RHP zero.

$$C_P = \frac{1}{2\pi \times f_{RHP_Z} \times R_{COMP}}$$

Gate Drive Design

A 10-20 Ω gate resistor is recommended as following figure.

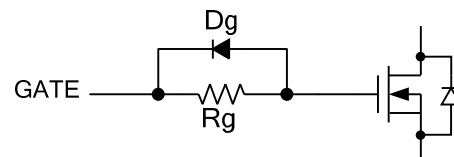
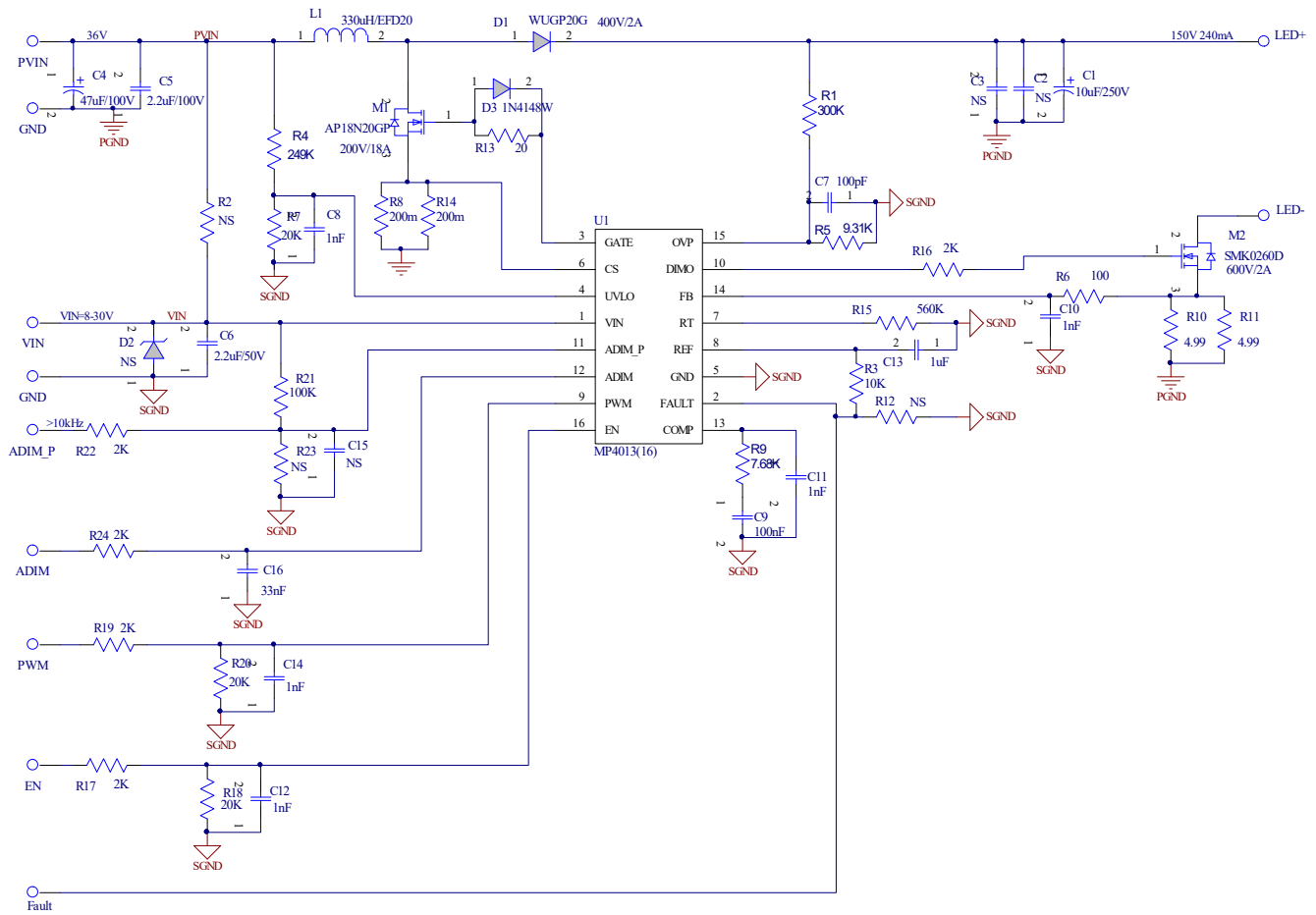
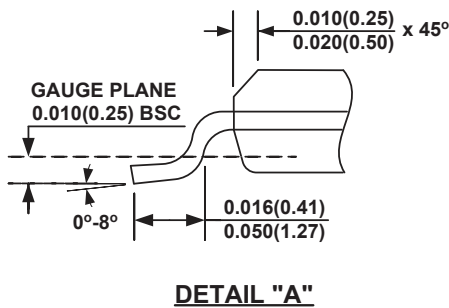
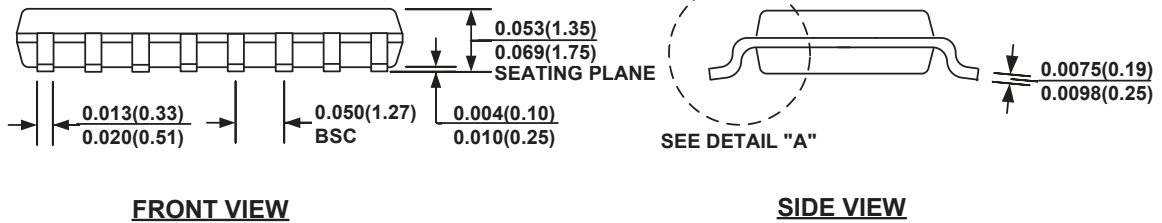
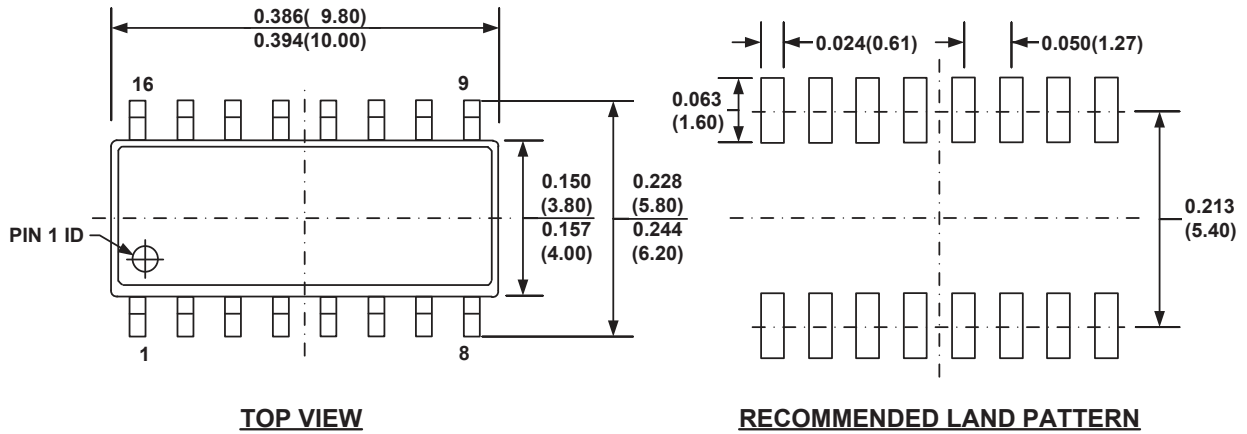

Figure 6: Gate Drive w/ Resistor

TYPICAL APPLICATION CIRCUIT



PACKAGE INFORMATION
SOIC-16

NOTE:

- 1) CONTROL DIMENSION IS IN INCHES. DIMENSION IN BRACKET IS IN MILLIMETERS.
- 2) PACKAGE LENGTH DOES NOT INCLUDE MOLD FLASH, PROTRUSIONS OR GATE BURRS.
- 3) PACKAGE WIDTH DOES NOT INCLUDE INTERLEAD FLASH OR PROTRUSIONS.
- 4) LEAD COPLANARITY (BOTTOM OF LEADS AFTER FORMING) SHALL BE 0.004" INCHES MAX.
- 5) DRAWING CONFORMS TO JEDEC MS-012, VARIATION AC.
- 6) DRAWING IS NOT TO SCALE.

NOTICE: The information in this document is subject to change without notice. Please contact MPS for current specifications. Users should warrant and guarantee that third party Intellectual Property rights are not infringed upon when integrating MPS products into any application. MPS will not assume any legal responsibility for any said applications.