

## DESCRIPTION

The MP103 provides an easy and low cost ACDC solution for less than 1W applications. It is an off-line linear regulator that delivers good efficiency while generating little EMI noise. It provides an easy solution to step down the AC line voltage to a regulated DC voltage. This off-line linear regulator replaces the conventional switching regulator, not needing a transformer or an inductor. Due to its simplicity, it offers an overall low BOM cost.

MP103 delivers nearly two times the output power than the MP100 or MP100L by charging its VB capacitor with an external bipolar transistor. MP103 maximizes efficiency by minimizing the voltage drop between VB and VOUT, while only charging VB when VIN is less than approximately 32V. The MP103 enables the overall system to meet standby power requirements.

MP103 offers rich protections, such as Thermal Shutdown (TSD), Over Temperature Protection (OTP), VB Over Voltage Protection (OVP), VB Short to GND Protection, Over Load Protection (OLP), Short Circuit Protection (SCP), MP103 is available in the SOIC8E package.

## FEATURES

- Universal AC Input (85Vac-305Vac)
- Inductor-less
- Less than 100mW standby power
- Excellent EMI Performance
- Lower BOM Cost
- Smart Control to Maximizes Efficiency
- Adjustable Output Voltage from 1.5V to 15V
- Good Line and Load Regulation
- Drives External BJT
- Short Circuit Protection
- External Programmable Over Temperature Protection (OTP)

## APPLICATIONS

- Wall switches and dimmers
- AC/DC Power Supply for Wireless System, like ZigBee, Z-Wave
- Standby Power for General Off-Line Applications

All MPS parts are lead-free and adhere to the RoHS directive. For MPS green status, please visit MPS website under Products, Quality Assurance page.

"MPS" and "The Future of Analog IC Technology" are registered trademarks of Monolithic Power Systems, Inc.

## TYPICAL APPLICATION

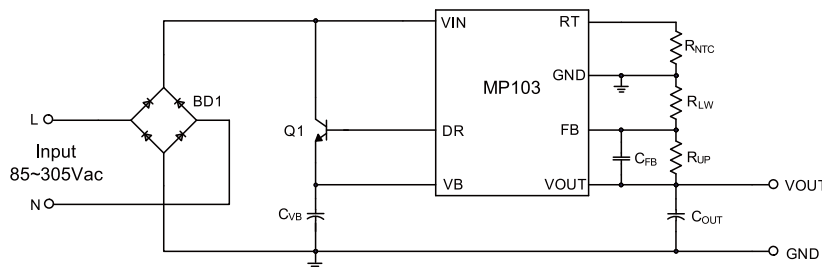

Output Power vs. Input Voltage

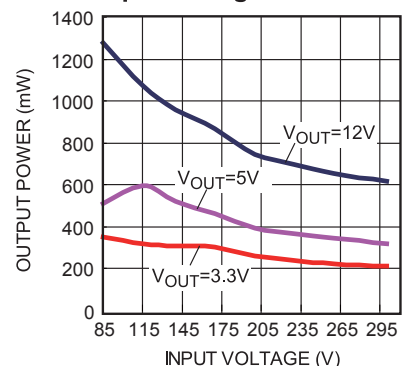

**ORDERING INFORMATION**

Part Number*	Package	Top Marking
MP103GN	SOIC8E	MP103

\* For Tape & Reel, add suffix –Z (e.g. MP103GN–Z);

**PACKAGE REFERENCE**

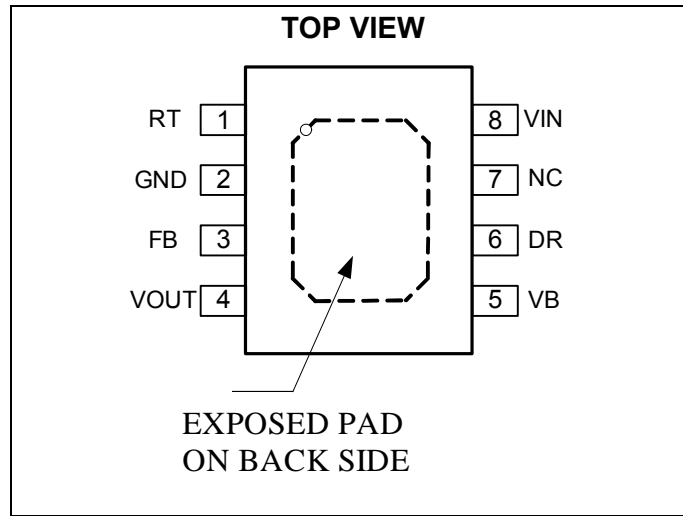

**ABSOLUTE MAXIMUM RATINGS** <sup>(1)</sup>

VIN .....	-0.7V to 700V
VOUT .....	-0.3V to 15V
VB.....	-0.3V to 35V
DR .....	-0.3V to 30V
FB.....	-0.3V to 6.5V
RT.....	-0.3V to 6.5V
Continuous Power Dissipation ( $T_A = +25^{\circ}\text{C}$ ) <sup>(2)</sup>	
SOIC8E .....	2.5W
Junction Temperature .....	150 °C
Lead Temperature .....	260 °C
Storage Temperature.....	-55 °C to +150 °C
ESD Capability Human Body Mode .....	2kV

**Recommended Operating Conditions** <sup>(3)</sup>

50/60Hz AC RMS Voltage .....	85V to 305V
VB.....	8V to 30V
Operating Junction Temp $T_J$ ....	-40°C to +150°C

Thermal Resistance <sup>(4)</sup>	$\theta_{JA}$	$\theta_{JC}$
SOIC8E	50.....	10 °C/W

**Notes:**

- 1) Exceeding these ratings may damage the device.
- 2) The maximum allowable power dissipation is a function of the maximum junction temperature  $T_J$  (MAX), the junction-to-ambient thermal resistance  $\theta_{JA}$ , and the ambient temperature  $T_A$ . The maximum allowable continuous power dissipation at any ambient temperature is calculated by  $P_D$  (MAX) =  $(T_J$  (MAX)- $T_A$ )/ $\theta_{JA}$ . Exceeding the maximum allowable power dissipation will cause excessive die temperature, and the regulator will go into thermal shutdown. Internal thermal shutdown circuitry protects the device from permanent damage.
- 3) The device is not guaranteed to function outside of its operating conditions.
- 4) Measured on JESD51-7, 4-layer PCB.

## ELECTRICAL CHARACTERISTICS

$T_A = -40^{\circ}\text{C}$  to  $+125^{\circ}\text{C}$ ,  $C_{FB}=100\text{pF}$ ,  $C_{OUT}=2.2\mu\text{F}$ ,  $C_{VB}=4.7\mu\text{F}$ , unless otherwise noted.

Parameter	Symbol	Condition	Min	Typ	Max	Units
<b>VIN Section</b>						
Input Voltage	VIN		650			V
Input Supply Current (Quiescent)	IIN <sub>QC</sub>	VIN= 90V & VB=0V, No load		48	85	μA
Input Voltage Slow Threshold	VIN <sub>THS</sub>	VIN Rising	30.5	32.75	36	V
Input Voltage Slow Threshold Hysteresis	VIN <sub>THS_HYS</sub>			3.2		V
Input Voltage Fast Threshold	VIN <sub>THF</sub>	VIN Rising	66	71	83	V
Input Voltage Fast Threshold Hysteresis	VIN <sub>THF_HYS</sub>			5.7		V
<b>VB Section</b>						
VB Peak Voltage Limit	VB <sub>PKLMT</sub>	VOUT=5V	13.0	13.75	14.5	V
		VOUT=12V	19.8	21.0	22.2	V
VB Peak Voltage Hysteresis	VB <sub>PKLMT_HYS</sub>	VOUT=5V		700		mV
		VOUT=12V		830		mV
VB Under Voltage Lock Out	VB <sub>UVLO</sub>		6.6	7.6	8.6	V
VB Output Enable Threshold	VB <sub>THOUT</sub>		13.5	15.25	17	V
VB Supply Current (Quiescent)	VB <sub>QC</sub>	VB=30V		0.74	1.65	mA
Active Bleeder ON	VB <sub>BLDON</sub>	VOUT=5V	11.0	12.25	13.5	V
		VOUT=12V	18.0	19.25	20.5	V
Active Bleeder ON Hysteresis	VB <sub>BLDON_HYS</sub>	VOUT=5V		600		mV
		VOUT=12V		700		mV
Active Bleeder Current	IB <sub>BLD</sub>	T <sub>A</sub> = -40°C to 25 °C	350	470		μA
		T <sub>A</sub> = 25°C to 85 °C		530		μA
		T <sub>A</sub> = 85 °C to 125 °C		683	850	μA
<b>DR Section</b>						
Driver Current	IDR	VB > VB <sub>THOUT</sub>	165	200	235	mA
Startup Driver Current	IDR <sub>STARTUP</sub>	VB < VB <sub>THOUT</sub>	14.8	19	28	mA
Base Current Rise Rate	IDR <sub>RISE</sub> <sup>(5)</sup>			2.7		mA/μs
Base Current Fall Rate	IDR <sub>FALL</sub> <sup>(5)</sup>			2.15		mA/μs
<b>VOUT Section</b>						
VOUT Regulated Voltage	VOUT		11.7	12.1	12.5	V
Output Current Capability <sup>(6)</sup>	IOUT	VAC=300rms, β=10, IDR=200mA		50		mA
Output Current Limit	IOUT <sub>LMT</sub>	VB=15V		170	230	mA
Line Regulation <sup>(7)</sup>		VB=13V to 30V, IOUT=100μA		0.04		%
Load Regulation <sup>(8)</sup>		VB=30V, IOUT=100μA to 40mA		0.14		%

**ELECTRICAL CHARACTERISTICS** <sup>(5)</sup> (continued)

 $T_A = -40^{\circ}\text{C}$  to  $+125^{\circ}\text{C}$ ,  $C_{FB}=100\text{pF}$ ,  $C_{OUT}=2.2\mu\text{F}$ ,  $C_{VB}=4.7\mu\text{F}$ , unless otherwise noted.

Parameter	Symbol	Condition	Min	Typ	Max	Units
Dropout Voltage <sup>(9)</sup>	$V_{DROP}$	$V_B=20\text{V}, I_{OUT}=40\text{mA}$		0.55		V
Ground Pin Current	$I_G$	$V_B=20\text{V}, I_{OUT}=40\text{mA}$		1.31		mA
PSRR <sup>(10)</sup>	PSRR	10~60kHz, $C_{IN}=1\mu\text{F}, C_{OUT}=4.7\mu\text{F}$		<60		dB
<b>FB Section</b>						
Reference Voltage	$V_{FBREF}$		1.204	1.235	1.266	V
<b>RT Section</b>						
Output Current of RT Pin	$I_{RT}$	$R_I=100\text{k}\Omega$ <sup>(11)</sup>	64	77	90	$\mu\text{A}$
RT Low Threshold Voltage	$V_{RT_{THL}}$		0.75		0.85	V
RT Threshold Voltage Hysteresis	$V_{RT_{TH\_HYS}}$			60		mV
RT Pin Open Voltage	$V_{RT_{OPEN}}$		5.3	5.8	6.3	V
<b>Thermal Shutdown</b>						
Thermal Shutdown Threshold	$T_{SD}$			160		$^{\circ}\text{C}$
Thermal Shutdown Threshold Hysteresis	$T_{SD\_HYS}$			20		$^{\circ}\text{C}$

**Notes:**

5) Took the linear region (Current) measure Time1 at 20% and Time2 at 80% to calculate the base current rise and fall rate.

6) Evaluate on EVB.

 7) Line Regulation =  $(V_{OUT} @ V_B=30\text{V}, 100\mu\text{A load} - V_{OUT} @ V_B=13\text{V}, 100\mu\text{A load}) / 12\text{V} * 100$ .

 8) Load Regulation =  $(V_{OUT} @ V_B=30\text{V}, 40\text{mA load} - V_{OUT} @ V_B=30\text{V}, 100\mu\text{A load}) / 12\text{V} * 100$ .

 9) The dropout voltage is defined as  $V_B - V_{OUT}$ .

10) Guarantee by design.

11) Or force 5V and 0.5V on RT, then measure RT current.

**TYPICAL CHARACTERISTICS**

**Input Supply Quiescent Current vs. Temperature**

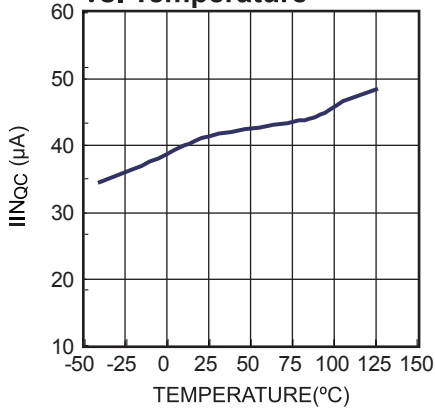

**Input Breakdown Voltage vs. Temperature**

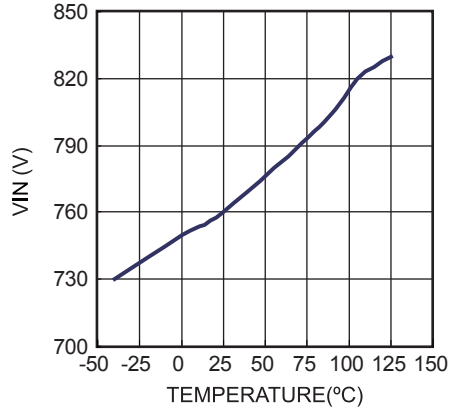

**Input Voltage Slow Threshold vs. Temperature**

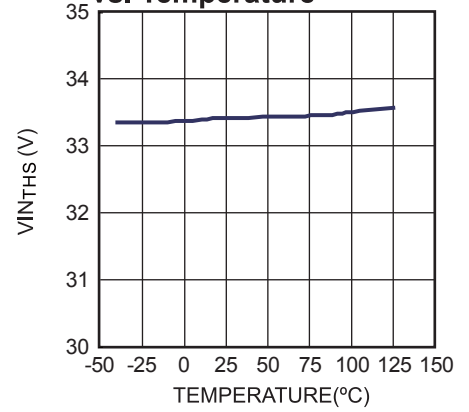

**Input Voltage Fast Threshold vs. Temperature**

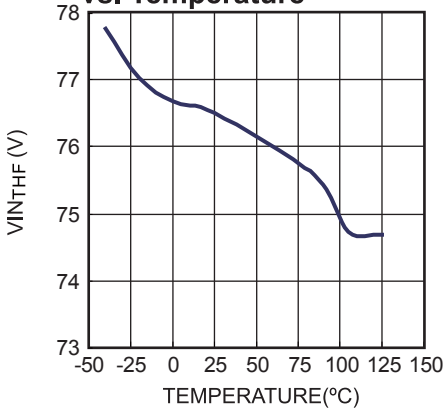

**Startup Driver Current vs. Temperature**

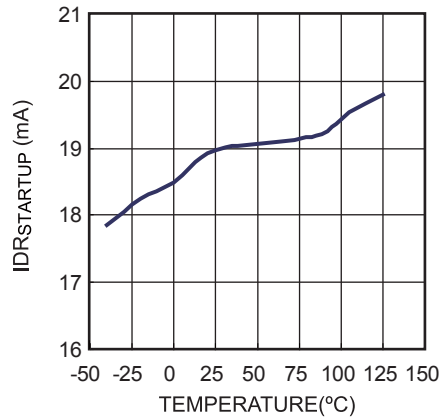

**Driver Current vs. Temperature**

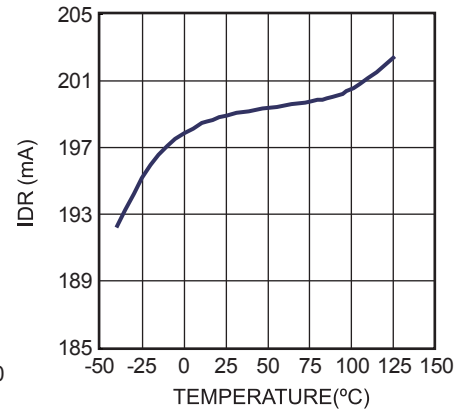

**Output Voltage vs. Temperature**

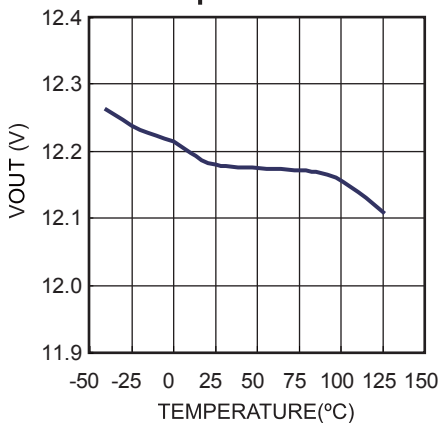

**Reference Voltage vs. Temperature**

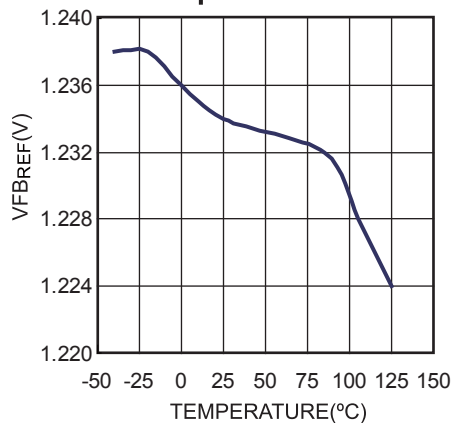

**Output Current Limit vs. Temperature**

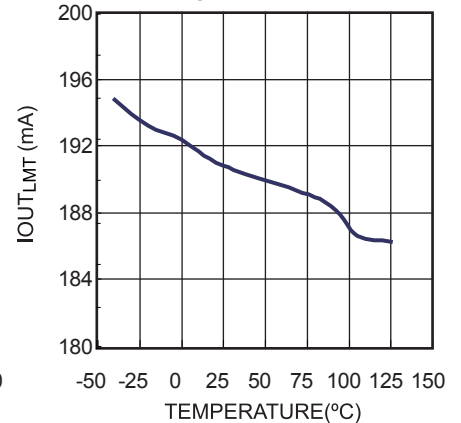

**TYPICAL CHARACTERISTICS (continued)**

**Ground Pin Current vs. Load Current**

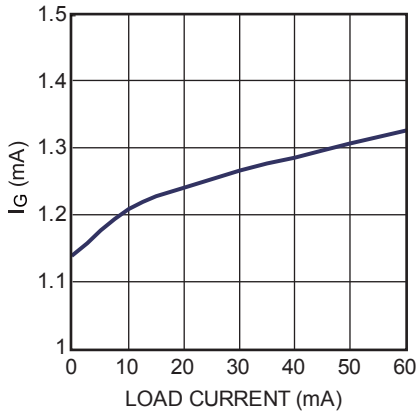

**RT Output Current vs. Temperature**

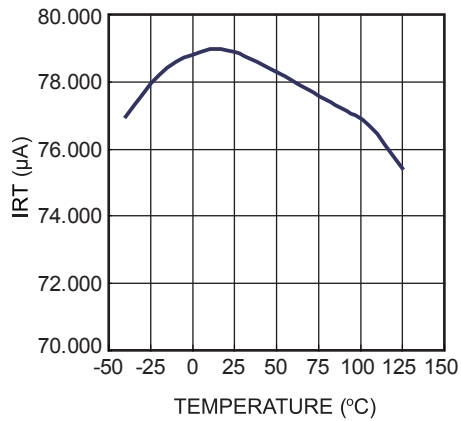

**RT Threshold Voltage vs. Temperature**

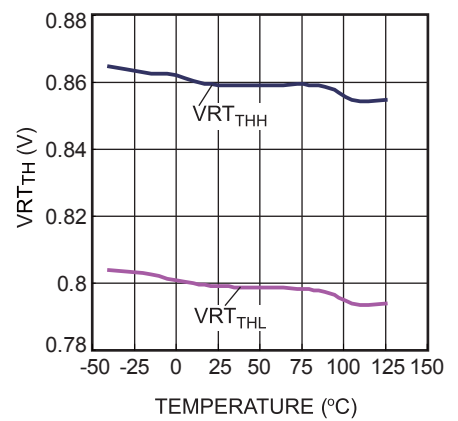

**Region of Stable C<sub>OUT</sub> ESR vs. Load Current**

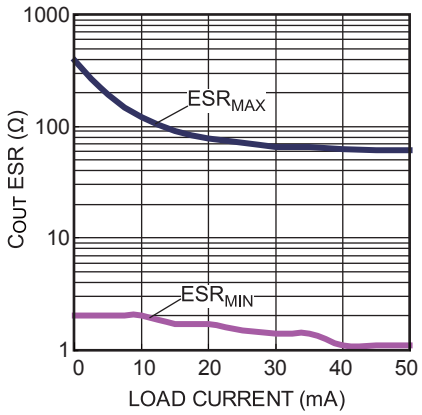

**PSRR**

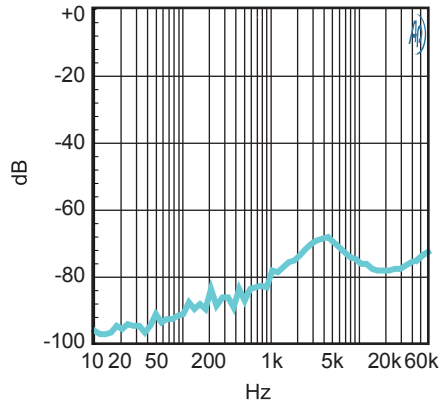

## TYPICAL PERFORMANCE CHARACTERISTICS

Performance waveforms are tested on the evaluation board of the Design Example section.

$V_{IN}=230V_{AC}$ ,  $V_{OUT}=5V$ ,  $I_{OUT}=60mA$ ,  $C_{VB}=470\mu F/25V$ ,  $T_A=+25^{\circ}C$ , unless otherwise noted.

**Input Power Start Up**

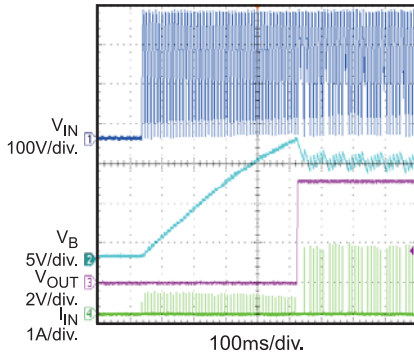

**Input Power Shut Down**

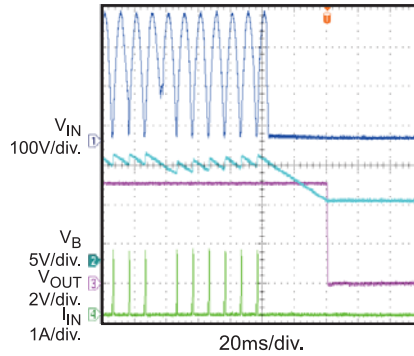

**Steady State**

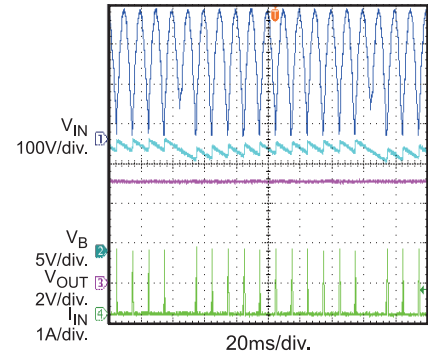

**Over Current Protection Entry**

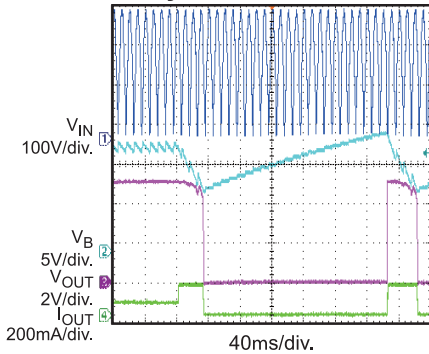

**Over Current Protection Recovery**

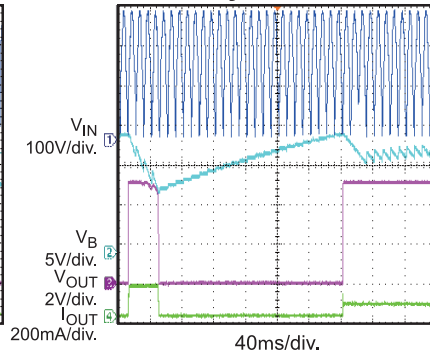

**Short Circuit Protection Entry**

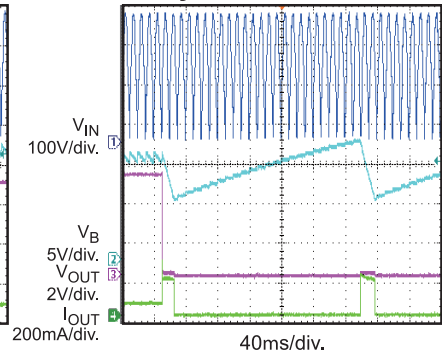

**Short Circuit Protection Recovery**

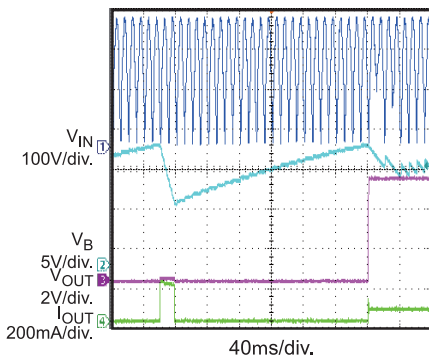

**VB Short to GND Protection Entry**

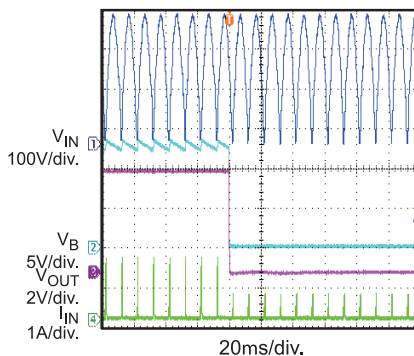

**VB Short to GND Protection Recovery**

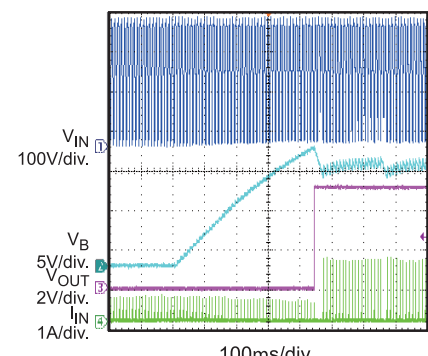

**TYPICAL PERFORMANCE CHARACTERISTICS** (continued)

Performance waveforms are tested on the evaluation board of the Design Example section.

$V_{IN}=230V_{AC}$ ,  $V_{OUT}=5V$ ,  $I_{OUT}=60mA$ ,  $C_{VB}=470\mu F/25V$ ,  $T_A=+25^{\circ}C$ , unless otherwise noted.

**Over Temperature Protection Entry**

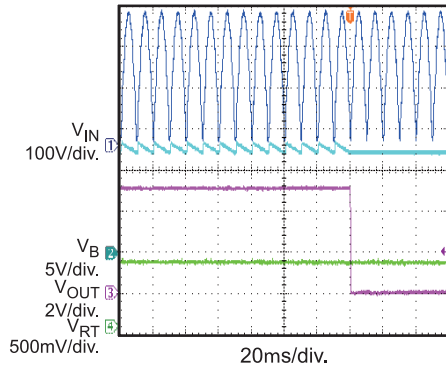

**Over Temperature Protection Recovery**

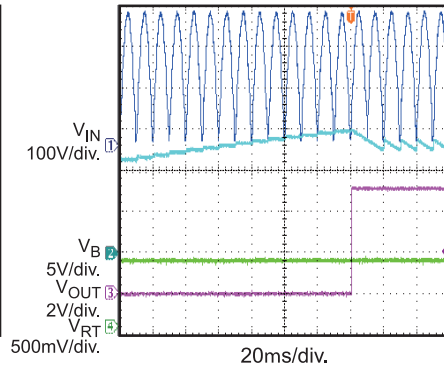

**Thermal Shutdown Protection Entry**

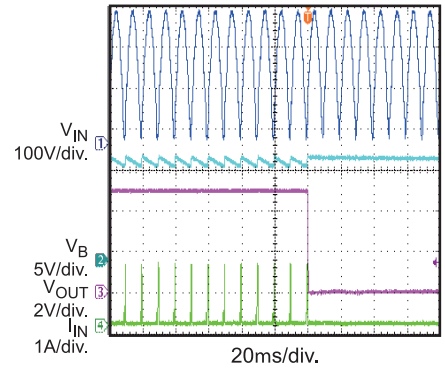

**Thermal Shutdown Protection Recovery**

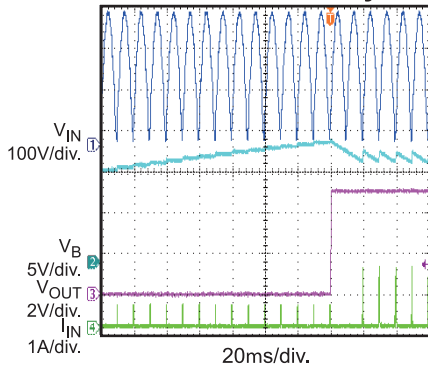

**Output Ripple**

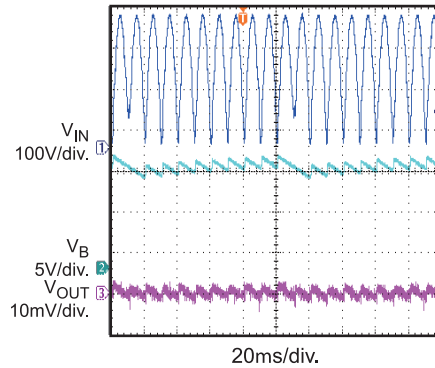

**Load Transient**

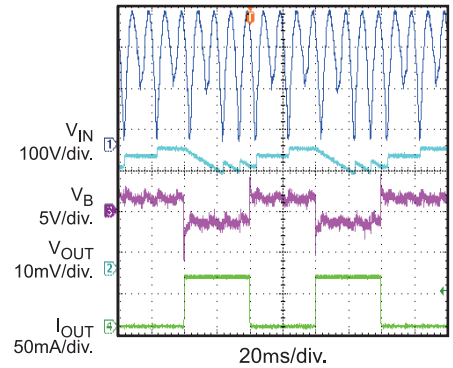



## PIN FUNCTIONS

Pin #	Name	Description
1	RT	Temperature sensing input pin. Connected through a NTC resistor to GND. Once the voltage of the RT pin drops below a fixed limit of 0.8V, DR output and LDO will be disabled. Let this pin float if external temperature sensing function is not used.
2	GND	Ground.
3	FB	Output voltage feedback. Connect to a capacitor to VOUT to improve low dropout stability. Internally voltage divider set the output to be 12V. Connect to the tap of a resistor divider to adjust the output voltage.
4	VOUT	Output Voltage.
5	VB	Connect a cap from this pin to GND to store the energy for the low drop-out stage.
6	DR	BJT driver pin. The driver is capable of providing 0.2A source current to drive external BJT.
7	NC	Not connected.
8	VIN	Voltage input supply. Providing energy when the voltage falls within the charging window.
Exposed Pad		Connect to a large copper surface connected to GND to enhance thermal dissipation.



## OPERATION

MP103 employs a smart inductor-less regulator design to supply a regulated DC voltage from an AC input. A unique (patent pending) charge algorithm transfers charge from the AC line when the line voltage is below 32V to the VB capacitor (C1 in the typical application diagram). The VB capacitor is used as the charge reservoir for an internal LDO to regulate VOUT. There are two distinct modes of normal operation; startup and steady state.

### Startup

At start up, all pins are at zero volts, and the AC line supplies power to VIN through the rectifier. An internal 19mA current source is enabled between VIN and DR. This current drives the base of an external bipolar transistor which charges the VB capacitor. This internal current source is only enabled when VIN is within its charging window, typically below 32V. This charging technique minimizes power loss during start up. During this start up condition,  $V_B < 15.25V$ , the output regulator is disabled. As long as  $V_B < 15.25V$ , DR provides 19mA during its charging window which limits the output current if VB is shorted. When  $V_B > 15.25V$ , the output regulator is enabled, and MP103 enters its steady state mode.

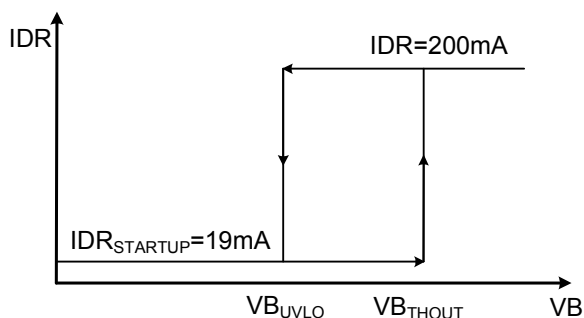

**Figure 2: Base Current vs. VB Voltage**

### Steady state

In steady state mode, DR current is increased to 200mA. Figure 2 depicts the relationship of the DR/base current to VB voltage. It is enabled during its charging window of  $V_{IN} < 32V$ . This technique adaptively replenishes the VB capacitor charge which supplies power

to the LDO. This enables good efficiency. An internal comparator will limit the VB voltage. These are the VB peak thresholds listed in the electrical table. This further improves efficiency by optimally limiting the drop out voltage depending on VOUT. If VB falls below 7.6V, the regulator will be disabled, turning off the power supply. The EMI performance is enhanced by turning on and off the current source at a controlled rate. The following sections describe in much more detail the steady state operation.

Figure 3 depicts the steady state waveforms for better understanding.

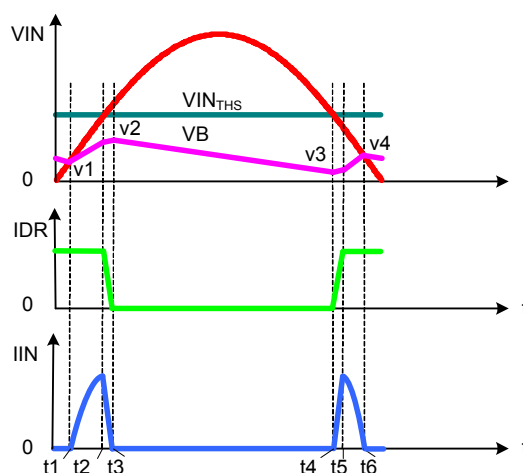

**Figure 3: Steady State Waveform**

[t1, t2]: At the time of t1, the voltage of VB and VIN is equal, then VIN is rising higher than VB, so there will be some charge current flowing into VB capacitor; At the time of t2, VIN reaches the slow turn-off threshold, the input current increased to its maximum value;

[t2, t3]: To benefit the EMI performance, MP103 will turn on and turn off the external BJT slowly with certain rate. At the time of t2, the driver reduces the driver current slowly to turn off the external BJT, at the time of t3, the external BJT is totally turned off;

[t3, t4]: During this period, the VIN is higher than the slow turn-off threshold, the driver is turned off and no current flowing into VB capacitor, the VB capacitor provides the power to LDO for output load, at the time of t4, the voltage of VB drops from v2 to v3;

[t4, t5]: At the time of t4, VIN falls to the slow turn-on threshold; the driver current begins to slowly rise to turn on the external BJT, at the time of t5, the external BJT is fully on;

[t5, t6]: As VIN falls, the charging current is decreased, and the VB voltage is increased by the charge current. At the time of t6, VIN falls to the value equal to VB voltage, there is no current flowing into VB capacitor;

[t6, t1]: During this period, although the driver is active, since VIN is lower than VB voltage, so there is no charging current, the VB capacitor provide the power for the output load and the voltage drop from v4 to v1 at the time of t1;

**Adaptive Active Charging Window**

To minimize the power loss of BJT and LDO, MP103 integrates an adaptive active charging window control, which maintain the maximum voltage difference between VB and VOUT stay at a constant level, thus the VB peak voltage is limited related to VOUT.

When VIN varies from high to low voltage into its charging window and the VB voltage is lower than VB<sub>PKLMT</sub> minus VB<sub>PKLMT\_HYS</sub>, then the driver will be turned on and VB capacitor will be charged up. If VB voltage is charged up to its peak limit VB<sub>PKLMT</sub> which is related with the output voltage, then the driver will be slowly turned off although VIN doesn't reach its slow turn-off threshold.

Figure 4 depicts the situation that VB reaches its peak limit when VIN is in its charging window.

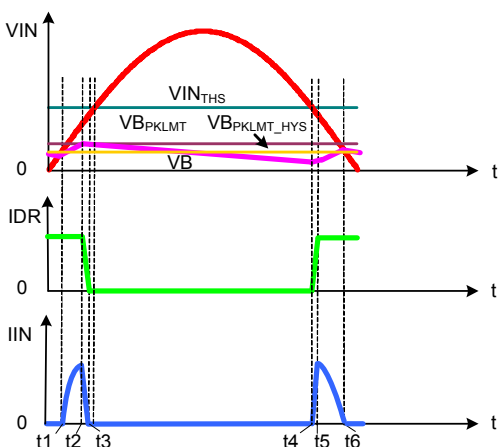

**Figure 4: Adaptive Active Charging Window**

**Active Bleeder Circuit**

Due to the parasitic capacitor of VIN to GND, the input voltage may not fall into its charging window during normal operation.

At start up, the active bleeder is always on to pull down the input voltage into its charging window to charge VB capacitor to its output enable threshold VB<sub>THOUT</sub> at which moment the LDO is enabled.

During steady state mode, to guarantee the output get enough energy from input ports, active bleeder circuit is enabled whenever the VB voltage falls below VB<sub>BLDON</sub>.

Besides, when the power supply is shut down, active bleeder circuit discharges the energy stored in parasitic capacitor to ensure the circuit can restart easily.

**Short Circuit Protection**

The output current is limited to 170mA (IOUT<sub>LMT</sub>) if the output is shorted to ground, which also decreases the VB voltage. When VB drops below 7.6V (VB<sub>UVLO</sub>), the LDO turns off. The input voltage then gradually charges VB up to 15.25V (VB<sub>THOUT</sub>) to enable the LDO. When LDO turns on, the output current drops the VB voltage to 7.6V again. This process will continue until the output short condition ceases.

**Over Load Protection**

The VB and VOUT voltages will drop simultaneously if the output current exceeds its normal value. When the VB voltage falls to 7.6V (VB<sub>UVLO</sub>), the second stage LDO shuts down immediately. Then the input voltage charges VB to 15.25V (VB<sub>THOUT</sub>) to enable the LDO. Due to the output current limit circuit, the maximum current is limited to 170mA (IOUT<sub>LMT</sub>) typically.

**VB Short to GND Protection**

When VB is shorted to GND, the driver current will be reduced to 19mA (IDR<sub>STARTUP</sub>) typically to decrease the power consumption of external BJT, thus the thermal damage of external BJT is prevented.

**Over Temperature Protection**

An NTC resistor in series with a regular resistor can be connected between RT and GND for

ambient temperature sensing and protection. The value of the NTC resistor becomes lower when the ambient temperature rises. With the fixed internal current 80uA flowing through the resistors, the voltage of RT pin becomes lower at high temperature. When VRT is lower than  $V_{RT\_THL}$  ( typically 0.8V ) , then internal OTP circuit will be triggered and the BJT driver and LDO will be shut down immediately. When VRT is higher than  $V_{RT\_THL}$  plus  $V_{RT\_TH\_HYS}$ , then MP103 will restart.

### **Thermal Shutdown Protection**

Accurate temperature protection prevents the chip from operating at exceedingly high temperatures. When the silicon die temperature exceeds 160°C, the whole chip shuts down. When the temperature falls below its lower threshold of 140 °C, the chip is enabled again.

## APPLICATION INFORMATION COMPONENT SELECTION

### Setting the Output Voltage

The output voltage is set to 12V by internal large feedback resistors. Typically, the internal upper and lower feedback resistor is 1.125MΩ and 125kΩ respectively. Adjust V<sub>OUT</sub> by choosing appropriate external feedback resistors. The recommended output voltage is between 1.5V and 15V. Defining the upper and lower feedback resistors as R<sub>UP</sub> and R<sub>LW</sub> respectively (refer to the picture in Typical Application section):

$$R_{UP} = R_{LW} \times \left( \frac{V_{OUT}}{1.235} - 1 \right)$$

For the external resistors to dominate over the internal resistors, select relatively small values of R<sub>UP</sub> and R<sub>LW</sub> compared to the internal resistors. However, to minimize the load consumption, avoid very small external resistors. For most applications, choose R<sub>LW</sub>=10.2kΩ. To accurately set the output voltage, select R<sub>UP</sub> that can counter the internal upper-feedback resistor value of 1.125MΩ typically. The table below lists typical resistor values for different output voltages.

**Table 1: Resistors Selecting vs. Output Voltage Setting**

V <sub>OUT</sub> (V)	R <sub>UP</sub> (kΩ)	R <sub>LW</sub> (kΩ)
1.5	2.21 (1%)	10.2 (1%)
3.3	16.9 (1%)	10.2 (1%)
5	30.9 (1%)	10.2 (1%)
15	121 (1%)	10.2 (1%)

### Selection of VB Capacitor

The bypass capacitor on the VB pin needs to be sufficiently large to support sufficient energy. Calculate the capacitance (in μF) based on the following equation:

$$C_{VB} = \frac{I_{OUT} \times \tau_s}{V_{ripple}}$$

Where, I<sub>OUT</sub> is the output current (mA); τ<sub>s</sub> is based on the type of input rectifier—for example, τ<sub>s</sub> is 20ms for a half-wave rectifier, and 10ms for a full-bridge rectifier, V<sub>ripple</sub> is the voltage ripple on

the VB capacitor—normally the ripple is limited to 2V to 3V. For best results, use a small ceramic capacitor and a large aluminum capacitor in parallel.

### Output Power Capability

The following factors influence the MP103's maximum output power: the input rectifier (full bridge or half-wave); the VB capacitor connected between VB and GND; the DC current gain and collector current of external BJT; the output voltage and the temperature-rise requirement of key components, which is relevant to different application environments.

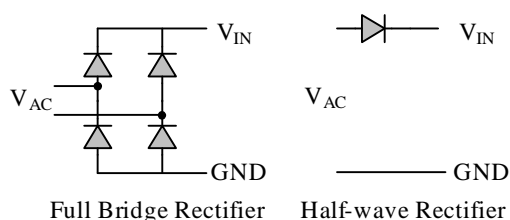
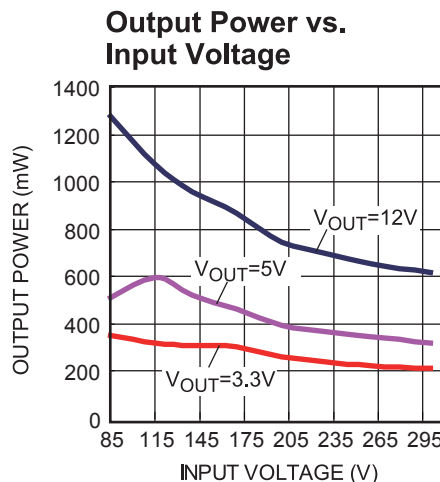

Figure 5 depicts the relationship between the maximum output power and the V<sub>IN</sub> voltage when the output voltage is 12V, 5V and 3.3V respectively. The plots account for the full bridge rectifiers, the temperature rise of MP103 is less than 60 °C on the test board in 25 °C room temperature test.



**Figure 5: Output Power vs. Input Voltage**

## EMI

To meet the relevant conducted emissions standard, slowly rise and fall the driver current is adopted to turn on and turn off the external BJT. Using this control method, a smaller X cap connected between the input ports will pass EMI with enough margins.

Besides, a capacitor connected between DR and VB will further slow down the switching process of external BJT for better EMI performance. The larger value this capacitor used, the slower switching process and better EMI performance will be got, however, the more power losses will be introduced by this capacitor and the longer startup process will be, so it is a compromise to select the value of the capacitor connected. Generally, with a 100nF X cap connected to pass EMI, a 2.2uF ceramic capacitor for 12V output and 4.7uF ceramic capacitor for 5V output is a good candidate to get good compromise.

## Surge

From its working principle, MP103 is working just when VIN falls into its charging window, so when surges happen at this moment, then a lot of energy will be absorbed by BJT and MP103 due to the slow turn off process. To protect them from damage, a fast turn off threshold (typically it is 71V) of VIN is set specially to shut down driver current quickly.

Since there is no bulk capacitor to absorb AC line transients, MOV should be used to protect the IC to survive the surge test. Besides the value of fuse resistor will also affect the surge result, the larger value used, the better to facilitate to pass the surge test, but the more power consumption will be caused, in the meanwhile, the larger value of fuse resistor used, the easier to trigger its fast turn off threshold, so 10~20 Ω fuse resistor is recommended in real application.

To pass 1kV surge test, 750V external BJT is recommended considering some margin, MP103 can pass 1kV surge test with an appropriate MOV such as TVR10431 connected between the line input ports.

Besides, the thermal pad must be connected to the GND for better surge performance.

## PCB Layout Guide

PCB layout is very important to achieve good regulation, ripple rejection, transient response and thermal performance. It is highly recommended to duplicate EVB layout for optimum performance. If change is necessary, please follow these guidelines and take figure 6 for reference.

- 1) Keep the trace from positive output rectifier to VIN as short and wide as possible.
- 2) Minimize the loop area formed by positive output of rectifier, emitter of external BJT and GND.
- 3) Minimize the loop area formed by VIN, collector of BJT, emitter of BJT.
- 4) Ensure all feedback connections are short and direct. Place the feedback resistors and compensation components as close to the chip as possible.
- 5) Place the NTC resistor as close to external BJT as possible for temperature detection and effective protection.
- 6) Output capacitor should be put close to the output terminal.
- 7) Connect the exposed pad with GND to a large copper area to improve thermal performance and long-term reliability.

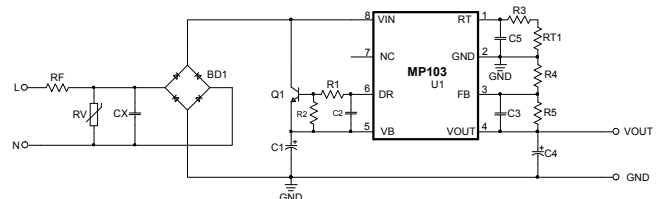

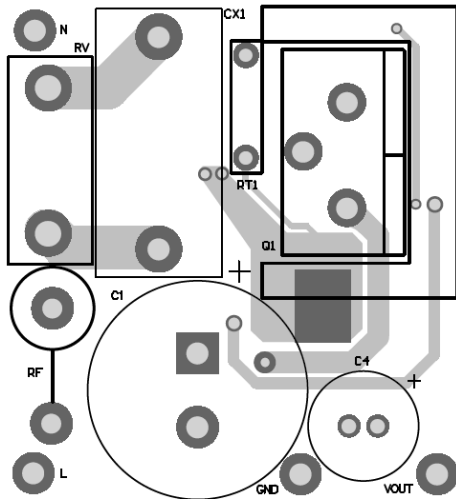

**Top Layer**

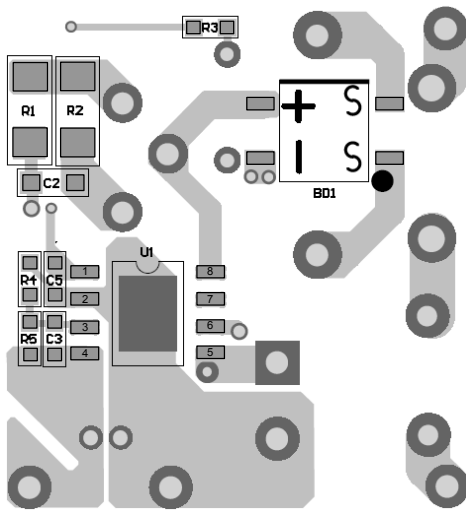

**Bottom Layer**

**Figure 6: PCB Layout**

**Design Example**

Below is a design example following the application guidelines for the specifications:

**Table 2: Design Example**

$V_{IN}$	85Vac to 265Vac
$V_{OUT}$	5V
$I_{OUT}$	60mA

The detailed application schematic is shown in Figure 7. The typical performance and circuit waveforms have been shown in the Typical Performance Characteristics section. For more device application, please refer to the related Evaluation Board Datasheets.



**TYPICAL APPLICATION CIRCUITS**

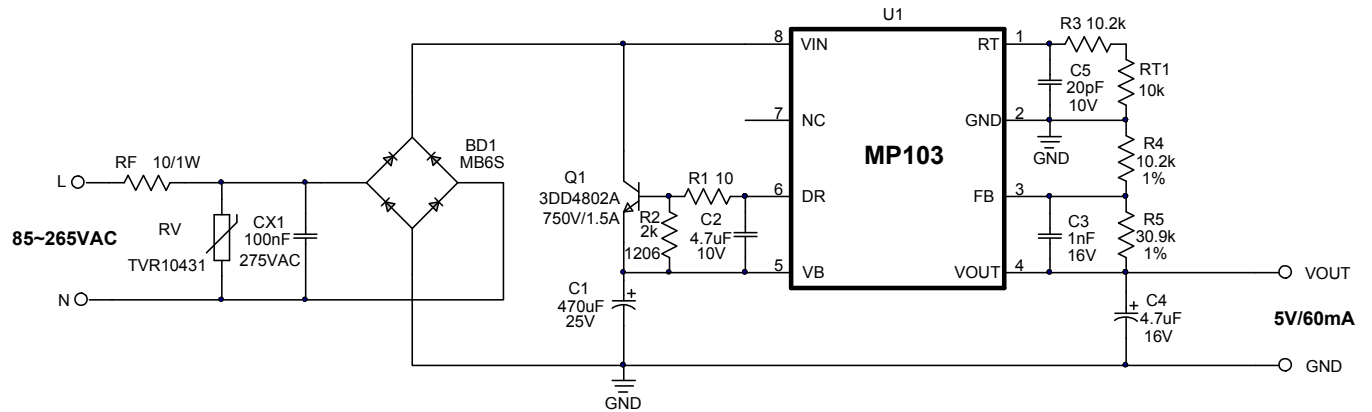

**Figure 7: Typical Application**

**FLOW CHART** <sup>(12)</sup>

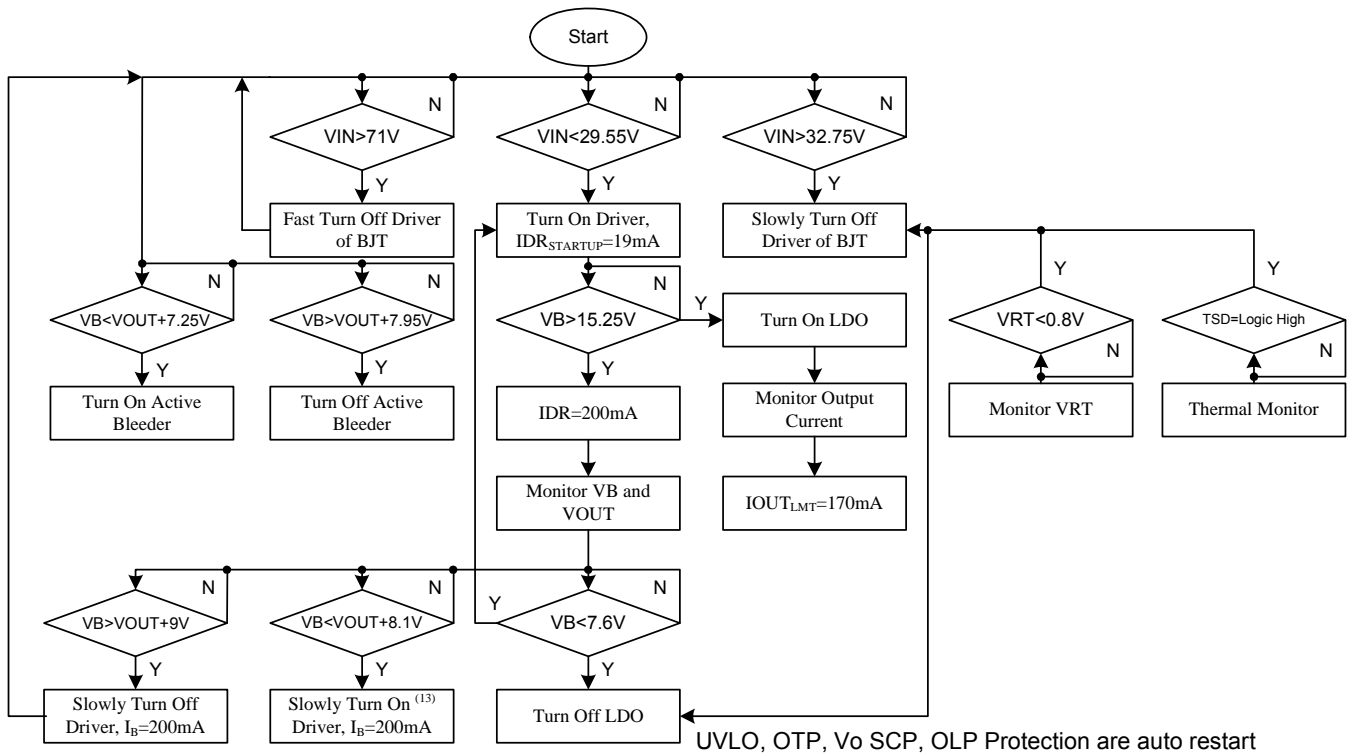

**Notes:**

12) The parameters in the flow chart refer to the 12V output voltage.

13) The 'slowly turn on' only happens when VIN is from high voltage to low voltage through VIN slow turn on threshold while VB is lower than its turn on threshold.

## EVOLUTION OF THE SIGNALS IN THE PRESENCE OF FAULTS

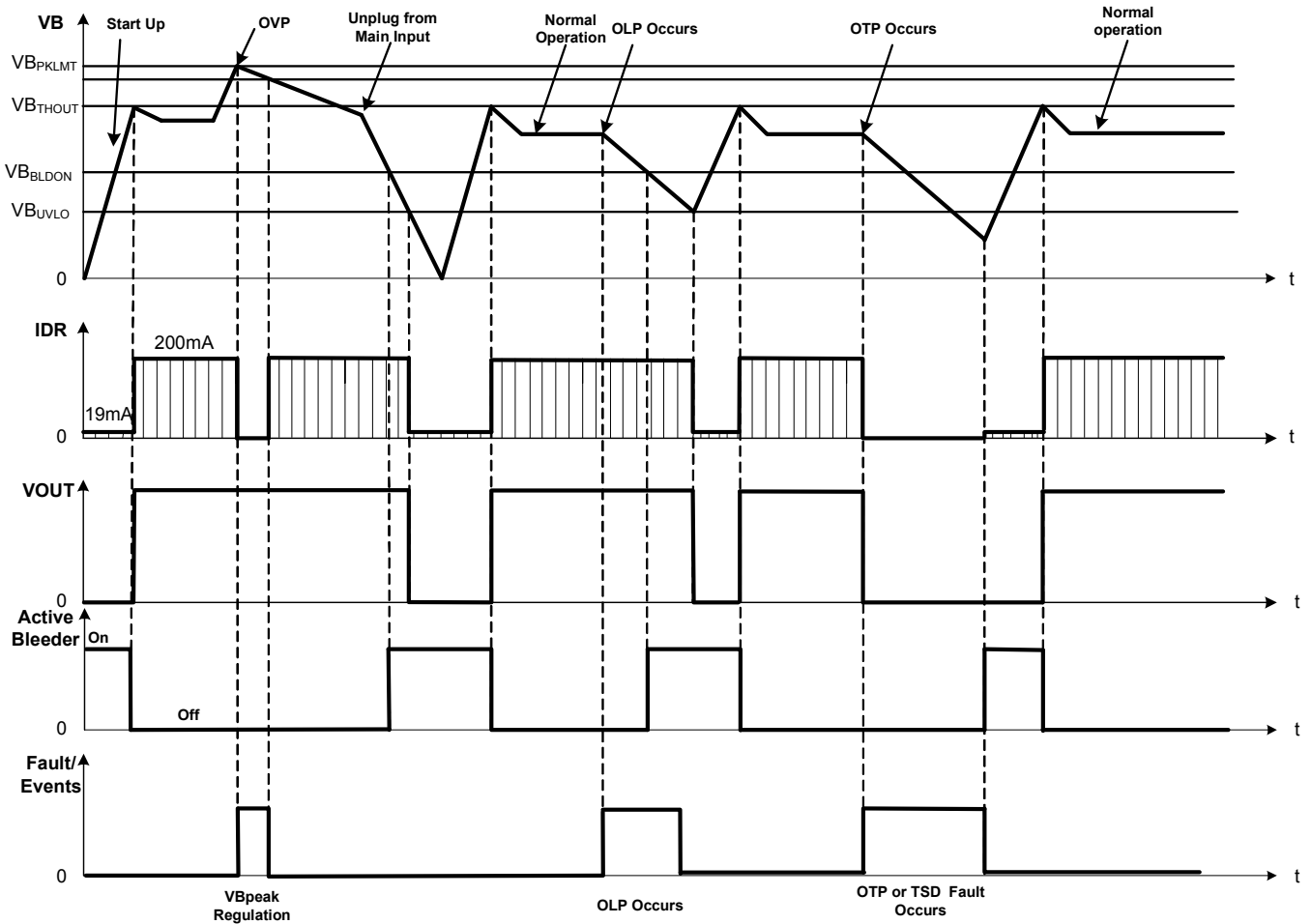

**PACKAGE INFORMATION**

**SOIC8E**

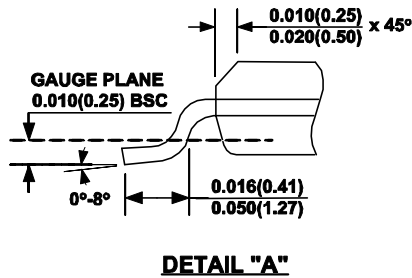
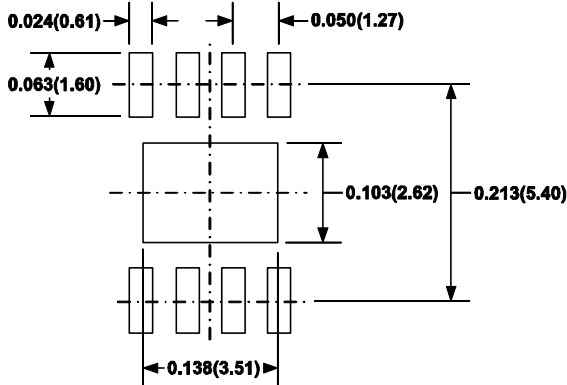
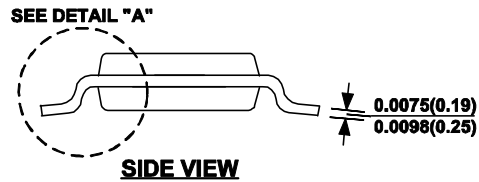
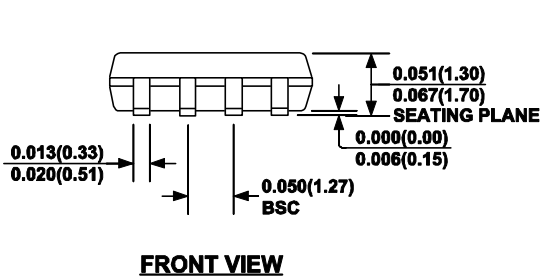
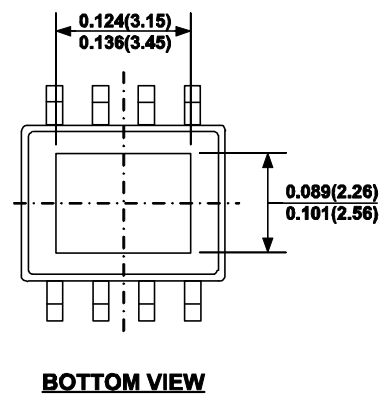
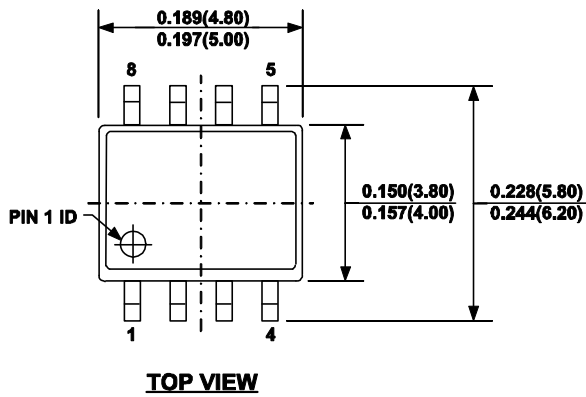

**NOTE:**

- 1) CONTROL DIMENSION IS IN INCHES. DIMENSION IN BRACKET IS IN MILLIMETERS.
- 2) PACKAGE LENGTH DOES NOT INCLUDE MOLD FLASH, PROTRUSIONS OR GATE BURRS.
- 3) PACKAGE WIDTH DOES NOT INCLUDE INTERLEAD FLASH OR PROTRUSIONS.
- 4) LEAD COPLANARITY (BOTTOM OF LEADS AFTER FORMING) SHALL BE 0.004" INCHES MAX.
- 5) DRAWING CONFORMS TO JEDEC MS-012, VARIATION BA.
- 6) DRAWING IS NOT TO SCALE.

**NOTICE:** The information in this document is subject to change without notice. Users should warrant and guarantee that third party Intellectual Property rights are not infringed upon when integrating MPS products into any application. MPS will not assume any legal responsibility for any said applications.