

DESCRIPTION

The EVQ4590-S-00A Evaluation Board is designed to demonstrate the capabilities of MPQ4590. The MPQ4590 is a primary-side constant voltage regulator providing accurate constant voltage (CV) regulation without Opto-coupler. It supports Buck, Buck-Boost, Boost and Flyback topologies.

The EVQ4590-S-00A Evaluation Board is designed as Buck application. EVQ4590-S-00A typically drives a 3.6W with a 12V/300mA load from 120V to 600V.

The EVQ4590-S-00A has an excellent efficiency and meets IEC61000-4-5 surge immunity and EN55022 conducted EMI requirements. MPQ4590 features various protections, including thermal shutdown (TSD), VCC under-voltage lockout (UVLO), over-load protection (OLP), short-circuit protection (SCP), and open loop protection.

MPQ4590GS is available in SOIC8 package.

ELECTRICAL SPECIFICATION

Parameter	Symbol	Value	Units
Input Voltage	V_{IN}	120 to 600	VDC
Output Voltage	V_{OUT}	12	V
Output Current	I_{OUT}	0.3	A
Output Power	P_{OUT}	3.6	W
Efficiency (full load)	η	>75	%

FEATURES

- Primary-Side non-isolated Constant Voltage (CV) Control
- Integrated 600V13.5 Ω MOSFET
- < 100mW No-load power consumption
- Up to 3.6W output power
- Peak-Current Control with Peak Current Compression
- Low Vcc operating current
- Limited Maximum Frequency
- Frequency Foldback
- Multiple Protections: SCP, OCP, OTP, and VCC UVLO
- Low Cost and Simple External circuit
- Internal high-voltage current source

APPLICATIONS

- Automotive PTC heater
- Electric or Hybrid car
- Industrial Controls
- Standby Power

All MPS parts are lead-free, halogen free, and adhere to the RoHS directive. For MPS green status, please visit MPS website under Quality Assurance. "MPS" and "The Future of Analog IC Technology" are Registered Trademarks of Monolithic Power Systems, Inc.



Warning: Although this board is designed to satisfy safety requirements, the engineering prototype has not been agency approved. Therefore, all testing should be performed using an isolation transformer to provide the AC input to the prototype board.

EVQ4590-S-00A EVALUATION BOARD



(L x W x H) 68mm x 28mm x 17mm

Board Number	MPS IC Number
EVQ4590-S-00A	MPQ4590GS

PCB LAYOUT (SINGLE-SIDED)

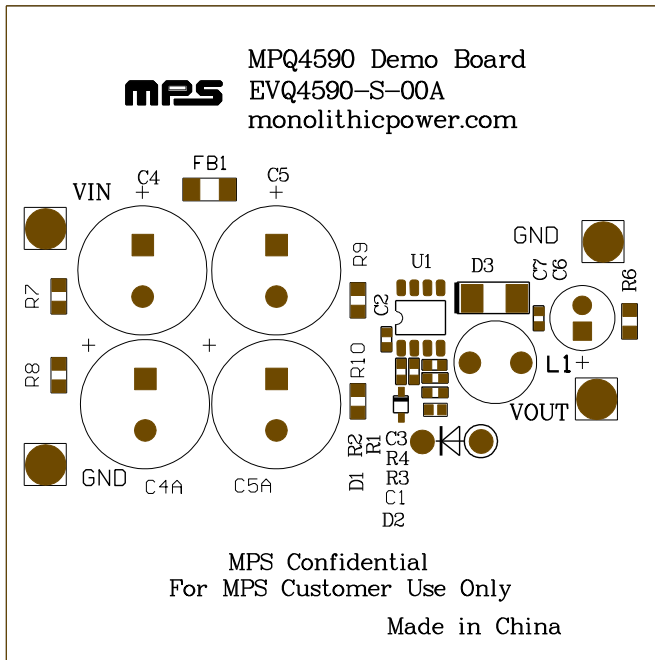

Figure 2—Top Silk Layer

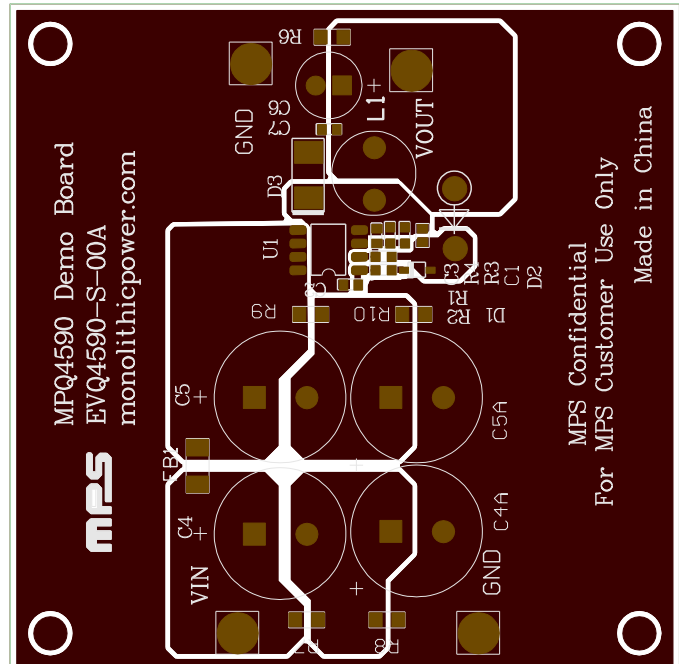

Figure 3—Top Layer

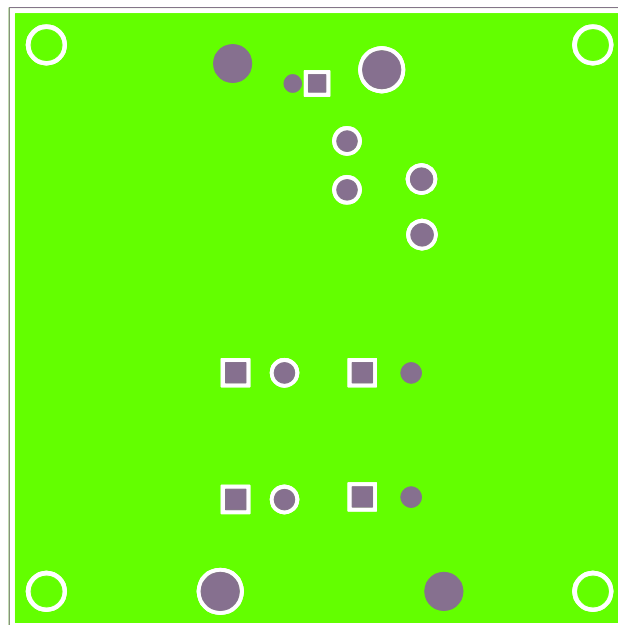

Figure 4—Bottom Layer

EVQ4590-S-00A BILL OF MATERIALS

Qty	Ref	Value	Description	Package	Manufacture	Manufacture_PN
1	C1	220nF	Ceramic Capacitor;25V;X7R;0603;	0603	WURTH Elektronik	885012206073
1	C2	2.2µF	Ceramic Capacitor;10V;X7R;0603;	0603	WURTH Elektronik	885012206027
1	C3	470pF	Ceramic Capacitor;50V;X7R;0603;	0603	WURTH Elektronik	885012206081
1	C6	100µF/25V	Electrolytic Capacitor;100µF; 25V;	2.5 x 6.3mm	WURTH Elektronik	860040473003
4	C4, C4A, C5, C5A	22µF/400V	Electrolytic Capacitor;22µF; 400V;	5x12.5x20	WURTH Elektronik	860021378013
1	C7	4.7uF	Ceramic Capacitor;4.7µF; 25V	0603	muRata	GRM188R61E475KE11D
1	D1	1N4148WS	Diode;75V;0.15A;	SOD-323	Diodes	1N4148WS-7-F
5	D2	1N4007	Diode;1000V;1A	DO-41	Diodes	1N4007
1	D3	STTH1R06A	Diode;600V;1A	SMA	ST	STTH1R06A
1	FB1	FB	FB 40mΩ; 3A	1206	WURTH Elektronik	742792111
1	L2	1.2mH	Inductor; 1.2mH; 2.6Ω; 400mA	Through Hold	WURTH Elektronik	768772122
1	R1	19.1K	Film Resistor;1%;	0603	Yageo	RC0603FR-0719K1L
1	R2	24K	Film Resistor;1%;	0603	Yageo	RC0603FR-0724KL
1	R3	NS	Film Resistor;5%	0603		
1	R4	4.99K	Film Resistor;1%;	0603	Yageo	RC0603FR-074K99L
1	R6	2K	Film Resistor;1%	0805	Yageo	RC0805FR-072KL
4	R7, R8, R9, R10	470K	Film Resistor;5%	0805	Vishay Dale	RCS0805470KJNEA
1	U1	MPQ4590	Primary side regulator	SOIC8	MPS	MPQ4590
2	VIN, GND		1.0			
2	Vout, GND		1.0			

CIRCUIT DESCRIPTION

The EVQ4590-S-00A is configured in a buck regulator topology, it uses primary-side-control which can mostly simplify the schematic and get a cost effective BOM. It can also achieve accurate constant voltage and acceptable cross regulation.

C4, FB1 and C5 compose π filter to guarantee the conducted EMI meet standard EN55022. C2 and C3 are also used for energy storage and protecting against line surge.

R2, C2, and D1 are used as VCC power supply. Though MPQ4590 is equipped with an internal high voltage current source, using this circuit can achieve better efficiency.

C1 is the sample-hold capacitor, used for reflecting output voltage. R1 and R4 are resistor divider for detecting output voltage by sampling voltage on C1.

D5 is the freewheeling diode. For universal voltage applications, use a diode with a 600V reverse block voltage. Ultra-fast recovery diode is recommended for better efficiency.

C6 and C7 are output capacitors for 12V output. C6 should be low ESR electrolytic capacitor for better output ripple. C7 is ceramic capacitor to reduce high frequency voltage ripple. R6 is dummy load to lower the output voltage of 12V rail at no load condition.

EVB TEST RESULTS

Performance waveforms are tested on the evaluation board.

$V_{IN}=120-350V$, $V_{OUT}=12V$, $I_{OUT}=0.3A$ CC Mode Load, $T_A=22\text{ }^\circ\text{C}$

Efficiency

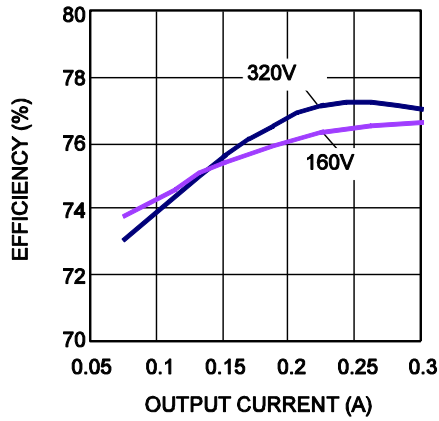

No Load Consumption

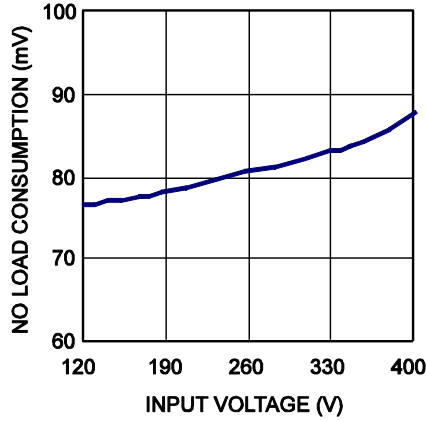

Steady State

$V_{IN}=160V$, Full Load

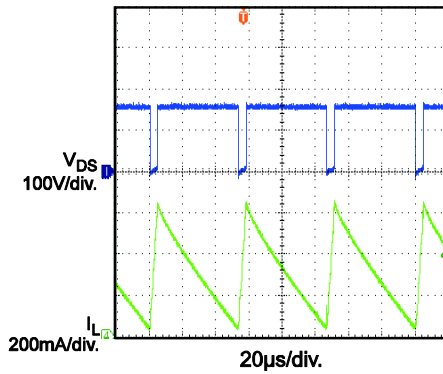

Steady State

$V_{IN}=320V$, Full Load

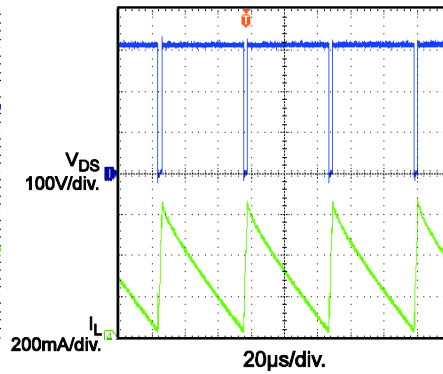

Output Ripple

$V_{IN}=160V$, No Load

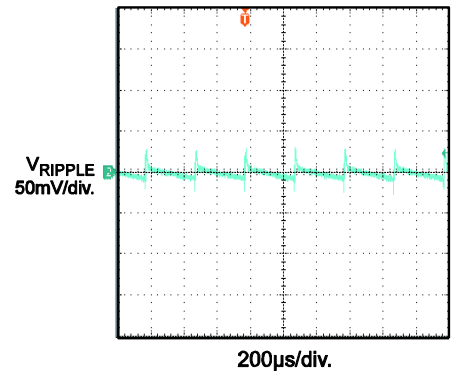

Output Ripple

$V_{IN}=160V$, Full Load

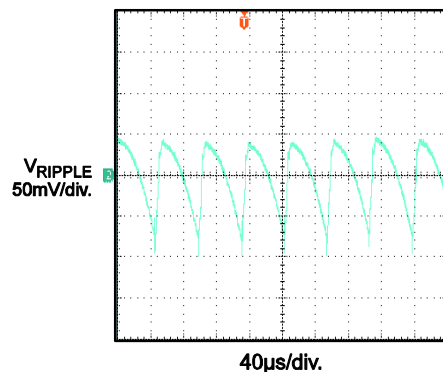

Output Ripple

$V_{IN}=320V$, No Load

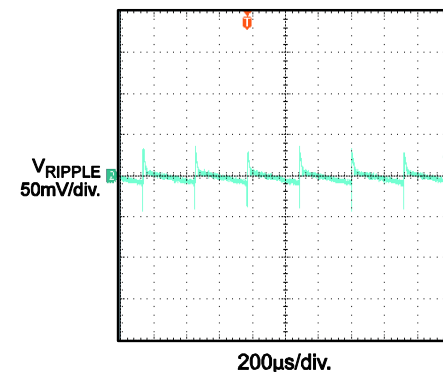

Output Ripple

$V_{IN}=320V$, Full Load

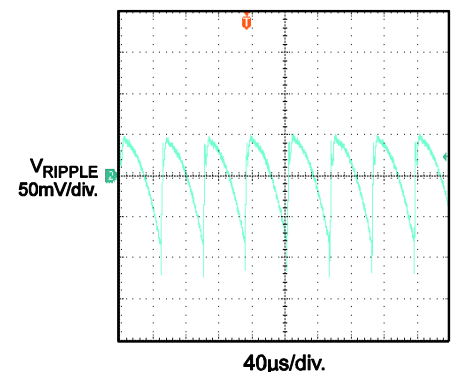

EVB TEST RESULTS (continued)

Performance waveforms are tested on the evaluation board.

$V_{IN}=120-350V$, $V_{OUT}=12V$, $I_{OUT}=0.3A$, CC Mode Load, $T_A=22\text{ }^\circ\text{C}$

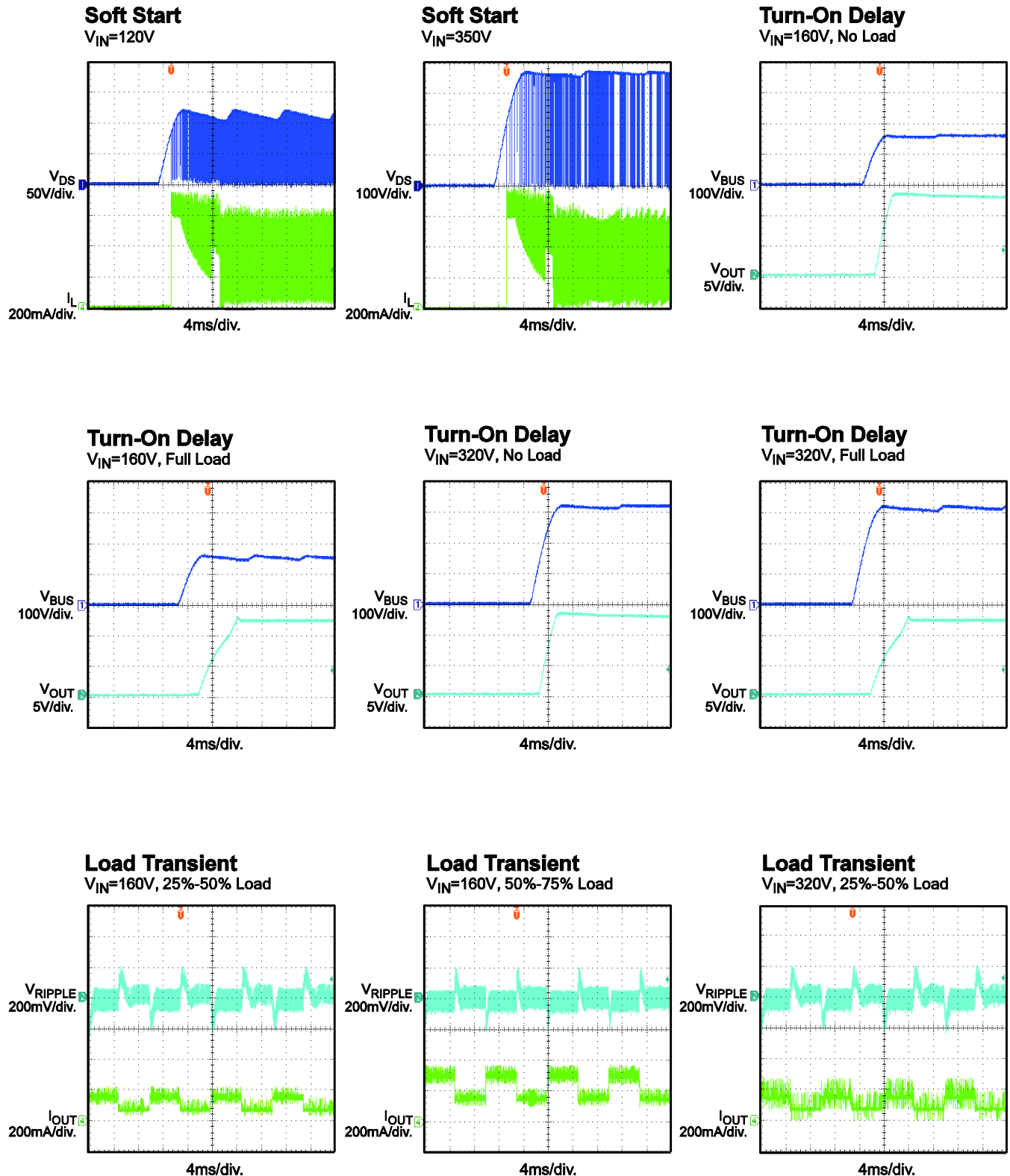

EVB TEST RESULTS *(continued)*

Performance waveforms are tested on the evaluation board.

$V_{IN}=120-350V$, $V_{OUT}=12V$, $I_{OUT}=0.3A$, CC Mode Load, $T_A=22\text{ }^\circ\text{C}$

Load Transient

$V_{IN}=320V$, 50%-75% Load

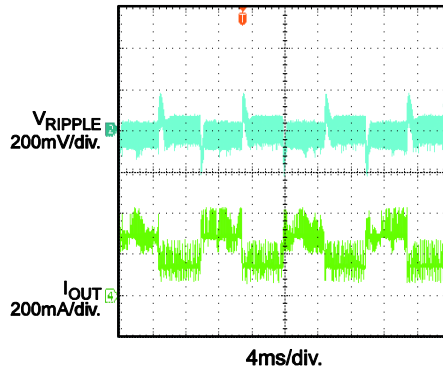

OTP

$V_{IN}=320V$

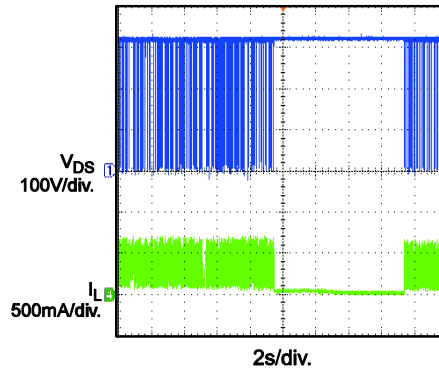

SCP

$V_{IN}=320V$

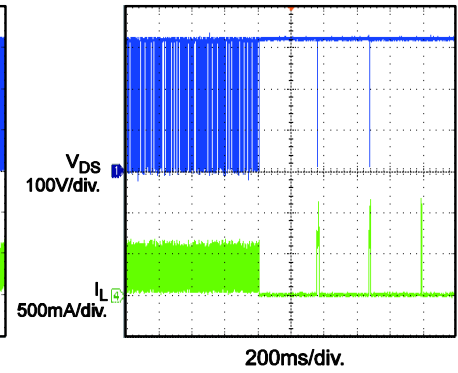

Open Loop Protection

$V_{IN}=320V$, No Load

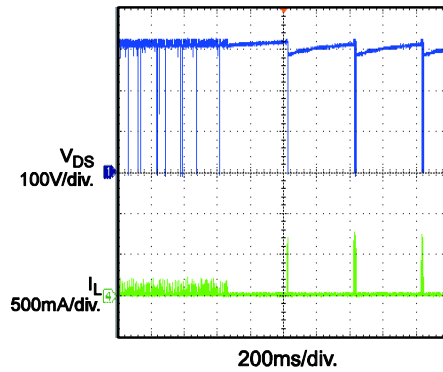

Open Loop Protection

$V_{IN}=320V$, Full Load

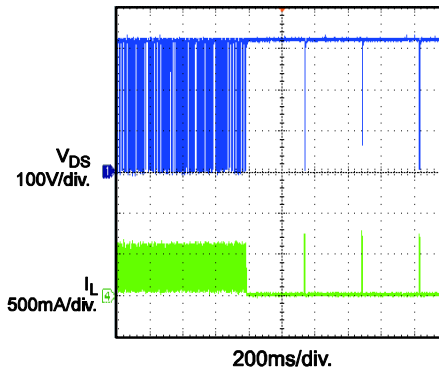

EVB TEST RESULTS *(continued)*

Performance waveforms are tested on the evaluation board.

$V_{IN}=120-350V$, $V_{OUT}=12V$, $I_{OUT}=0.3A$, CC Mode Load, $T_A=22\text{ }^{\circ}C$

Conducted EMI

Two-Wire Input, $V_{IN}=320V$, L Line

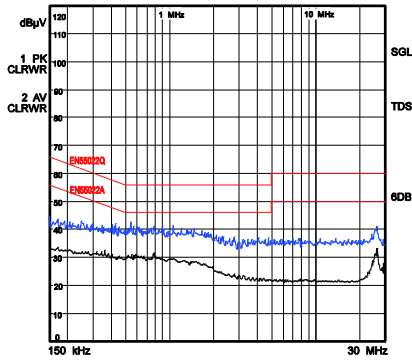

Conducted EMI

Two-Wire Input, $V_{IN}=320V$, N Line

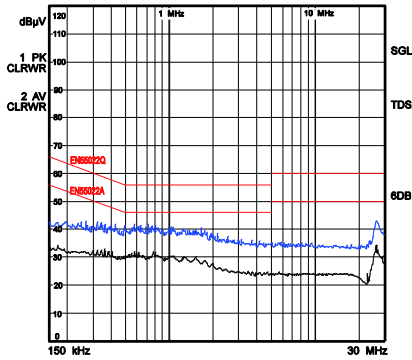

Conducted EMI

Two-Wire Input, $V_{IN}=320V$, L Line

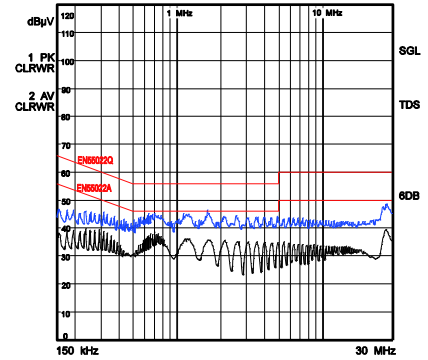

Conducted EMI

Two-Wire Input, $V_{IN}=320V$, N Line

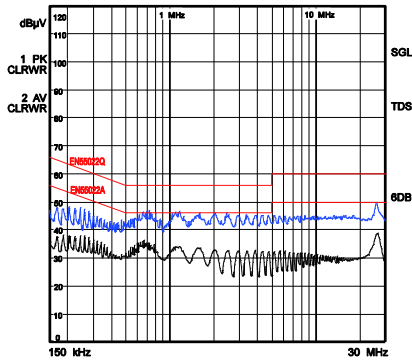

QUICK START GUIDE

1. Preset Power Supply to $120V \leq V_{IN} \leq 600V$.
2. Turn Power Supply off.
3. Connect the positive of the power supply output to the VIN pin and the negative terminal of the power supply to the GND pin.
4. Connect Different Load to Corresponding Outputs :
 - a. Positive (+): 12V OUT
 - b. Negative (-): GND
5. Turn Power Supply on after making connections.

NOTICE: The information in this document is subject to change without notice. Please contact MPS for current specifications. Users should warrant and guarantee that third party Intellectual Property rights are not infringed upon when integrating MPS products into any application. MPS will not assume any legal responsibility for any said applications.