

### DESCRIPTION

The EVQ2489-Q-00A is an evaluation board for the MPQ2489DQ, a step-down converter designed in continuous current mode for driving the high brightness light emitting diodes (LEDs) from wide input voltage 8V-36V. If higher input voltage (up to 60V) is required, use B190 instead of B140 in D1-D5.

The MPQ2489 employs hysteretic control architecture to regulate a high accuracy LED current, which is measured through an external high-side current sensing resistor. Moreover, this control scheme provides optimized circuit stabilization and very quick response time without the loop compensation. Its low 200mV average feedback voltage reduces power loss and improves the converter efficiency.

The MPQ2489 implements PWM and Analog Dimming with DIM pin. The MPQ2489 includes under-voltage lockout function, thermal overload protection preventing damage in the event of an output overload.

### ELECTRICAL SPECIFICATIONS

Parameter	Symbol	Value	Units
Input Voltage	$V_{IN}$	9 –24	V
Output Voltage	$V_{out}$	< $V_{in}$ -3V	
LED Current	$I_{LED}$	500	mA

### FEATURES

- Internal 65V MOSFET
- Wide 8V to 60V Input Range
- High Efficiency (Up to 94%)
- Hysteretic Control
- PWM & Analog Dimming
- 1000:1 PWM Dimming Resolution
- UVLO, Thermal Shutdown

### APPLICATIONS

- Low Voltage Halogen Replacement
- Low Voltage General Illumination
- Automotive/Decorative LED Lighting
- Signs/Emergency Lighting
- LED Backlighting

All MPS parts are lead-free, halogen free, and adhere to the RoHS directive. For MPS green status, please visit MPS website under Quality Assurance.

"MPS" and "The Future of Analog IC Technology" are Registered Trademarks of Monolithic Power Systems, Inc.

## EVQ2489-Q-00A EVALUATION BOARD



<b>(5x 4.6 x 0.8) cm xcm x cm</b>	
<b>Board Number</b>	<b>MPS IC Number</b>
EVQ2489-Q-00A	MPQ2489DQ

## EVALUATION BOARD SCHEMATIC

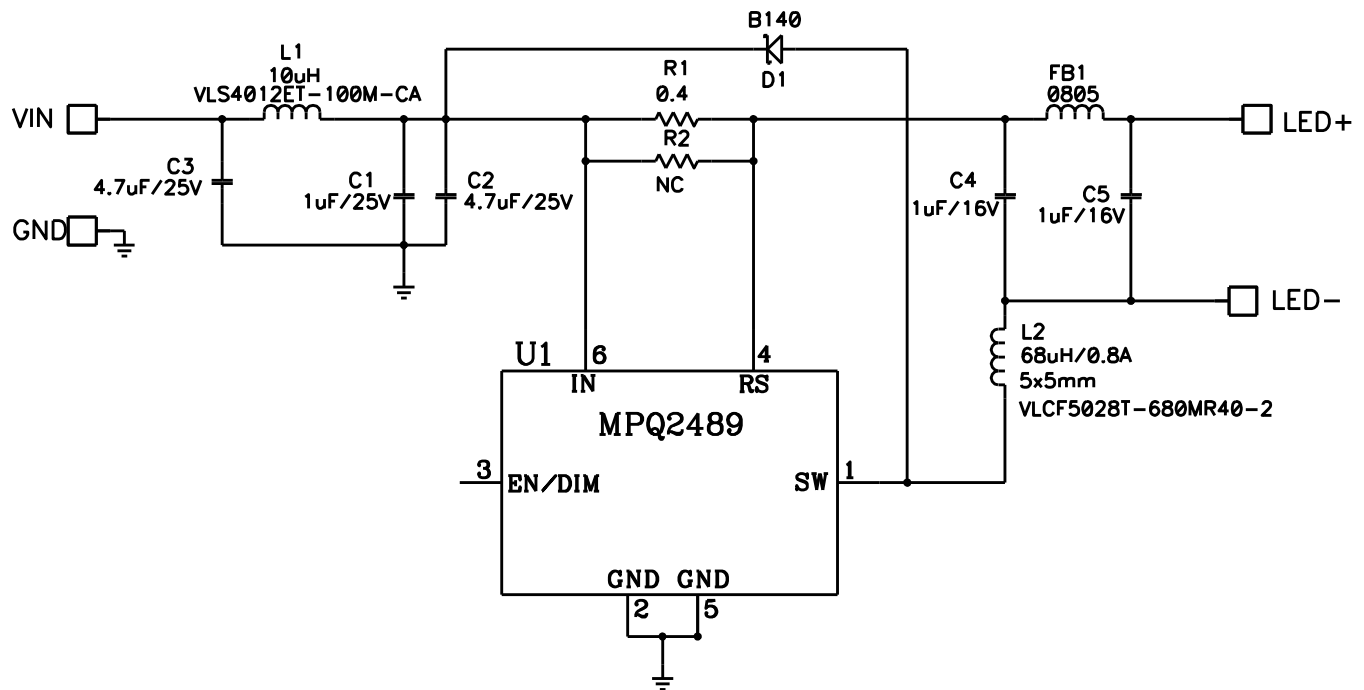

## EVQ2489-Q-00A BILL OF MATERIALS

Qty	Ref	Value	Description	Package	Manufacturer	Part Number
1	C1	1µF	Ceramic Capacitor,25V,X5R	0603	muRata	GRM188R61E105KA12D
2	C2, C3	4.7µF	Ceramic Capacitor,25V,X5R	0805	muRata	GRM21BR61E475KA12L
2	C4, C5	1µF	Ceramic Capacitor,16V,X5R	0603	muRata	GRM188R61C105KA93D
1	D1	B140	Diode Schottky	SMA	Diodes Inc.	B140
1	L1	10µH	Inductor 10µH	SMD	TDK	VLS4012ET-100M-CA
1	L2	68µH	Inductor 68µH 5x5mm	SMD	TDK	VLCF5028T-680MR40-2
1	FB1	FB	FB 3A/0.05Ω	0805	Wuth	742 792 023
1	R1	0.4Ω	1/3W Film Res., 1%	0805	Cyntec	RLT1220-F-R400-FNH
1	R2	NC		0805		
1	U1	MPQ2489DQ	MPS WLED Driver	QFN6	MPS	MPQ2489DQ

## EVB TEST RESULTS

Performance waveforms are tested on the evaluation board.

$V_{IN} = 30V$ , 3 LEDs in series,  $I_{OUT} = 550mA$ , unless otherwise noted.

**$I_Q$  Current vs.  $T_J$**

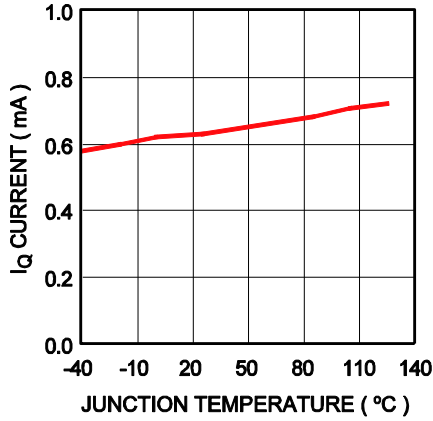

**$V_{RS}$  Reference vs.  $T_J$**

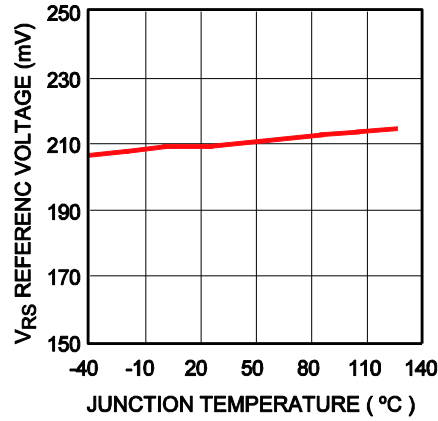

**Reference Voltage vs.  $T_J$**

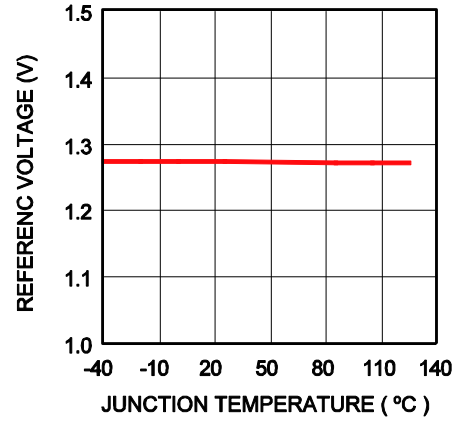

**PWM. Dimming Curve**

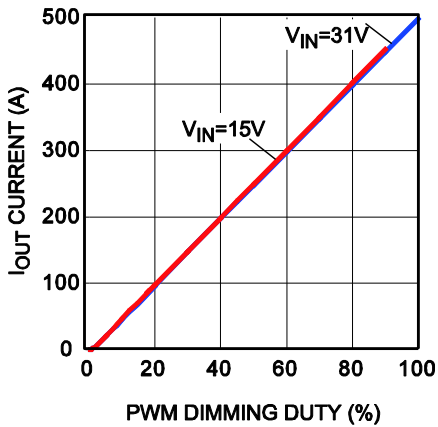

**$F_{SW}$  vs.  $T_J$**

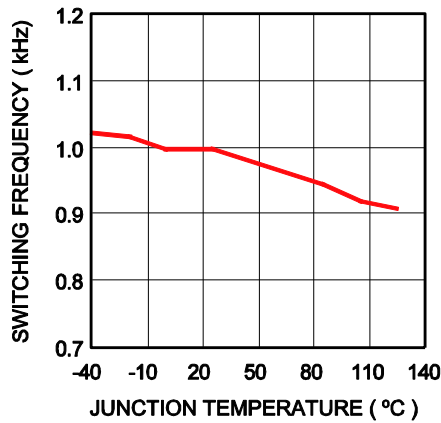

**$I_{OUT}$  Line Regulation**

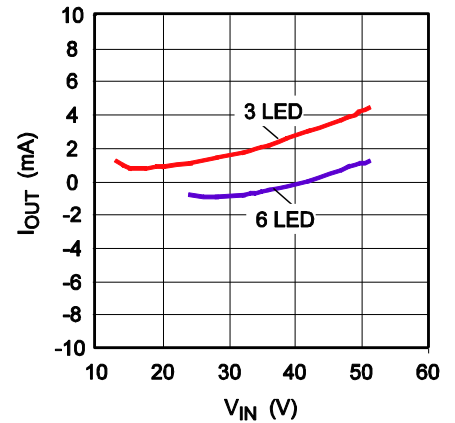

**Efficiency vs. Input Voltage**

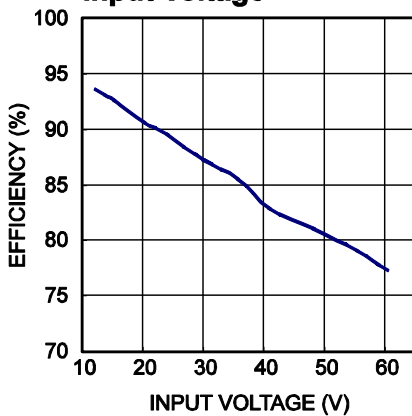

**Analog Dimming Curve**

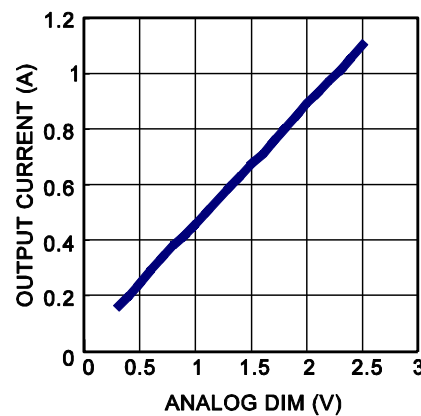

**$I_{LED}$  vs.  $R_{set}$**

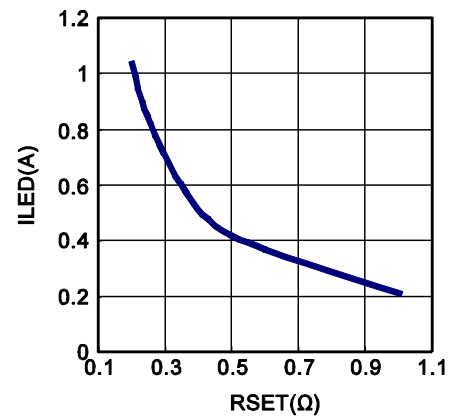

## EVB TEST RESULTS *(continued)*

Performance waveforms are tested on the evaluation board.

$V_{IN} = 30V$ , 3 LEDs in series,  $I_{OUT} = 550mA$ , unless otherwise noted.

### Steady State

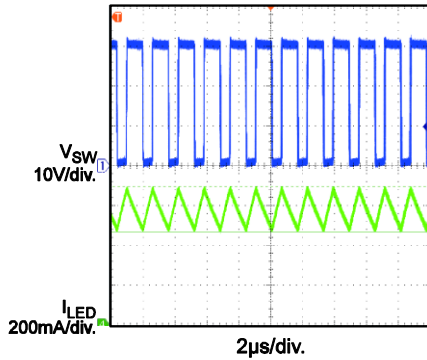

### Vin Startup

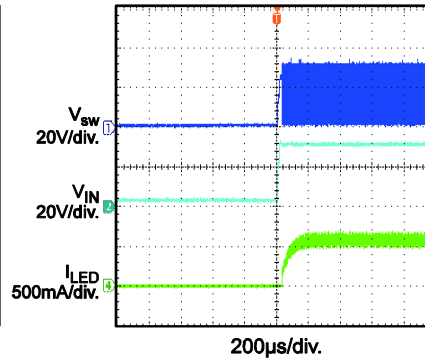

### Ven Startup

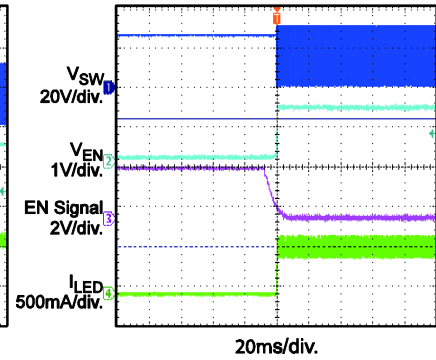

### PWM Dimming

$f_{PWM} = 200Hz$ ,  $D_{PWM} = 50\%$

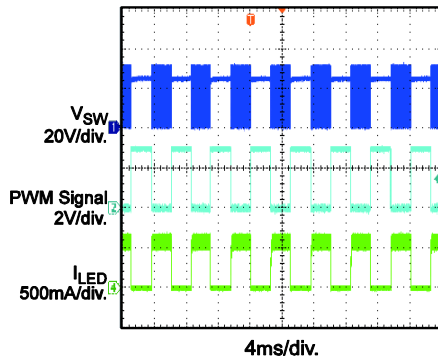

### Open LED Protection

Open LEDs at working

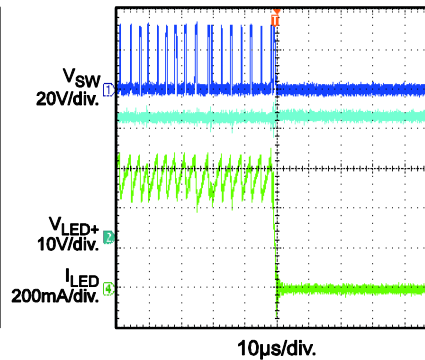

### Short LED Protection

Short LEDs at working

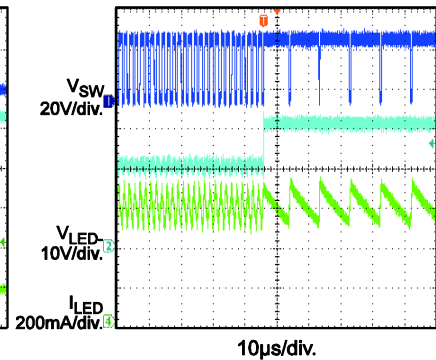

### Analog Dimming

$V_{ADIM} = 1.28V$ ,  $I_{OUT} = 527mA$ ,  $V_{IN} = 51V$

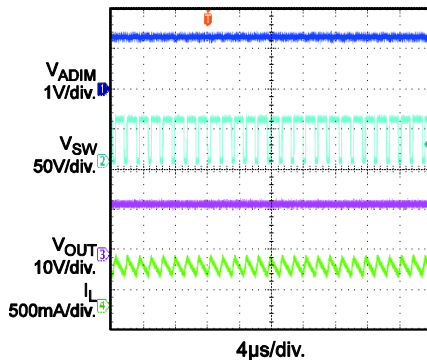

### Conduction EMI Performance

$V_{IN} = 12V$ ,  $I_{LED} = 0.5A$ , 2 LED

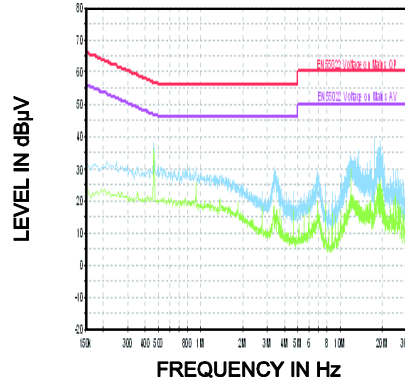

### Radiation EMI Performance

$V_{IN} = 12V$ ,  $I_{LED} = 0.5A$ , 2 LED

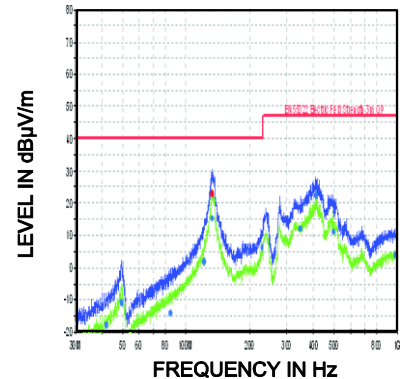

PRINTED CIRCUIT BOARD LAYOUT

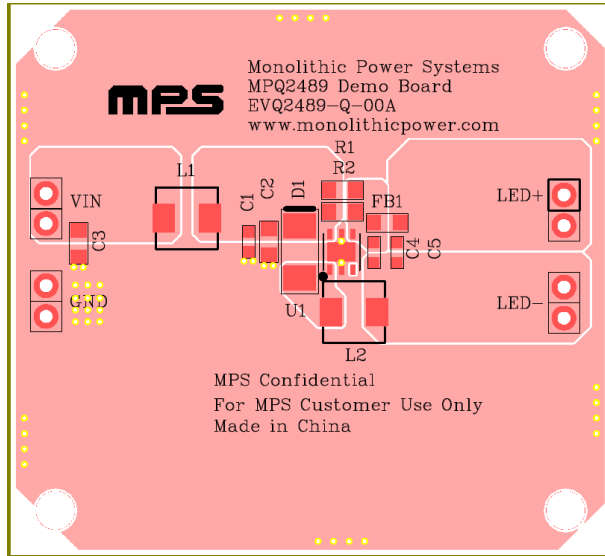

Figure 1—Top and Top Silk Layer

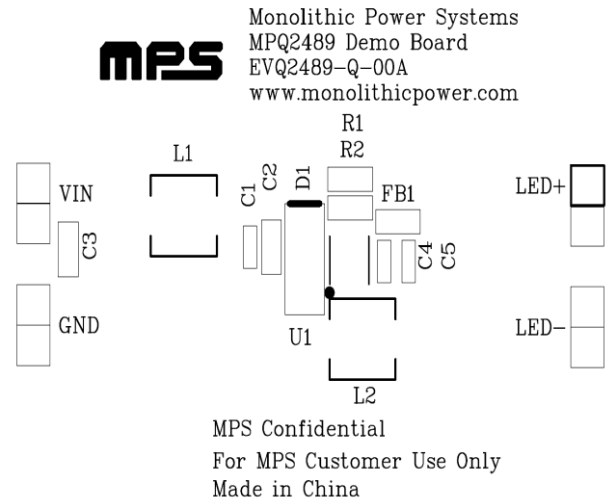

Figure 2—Top Silk Layer

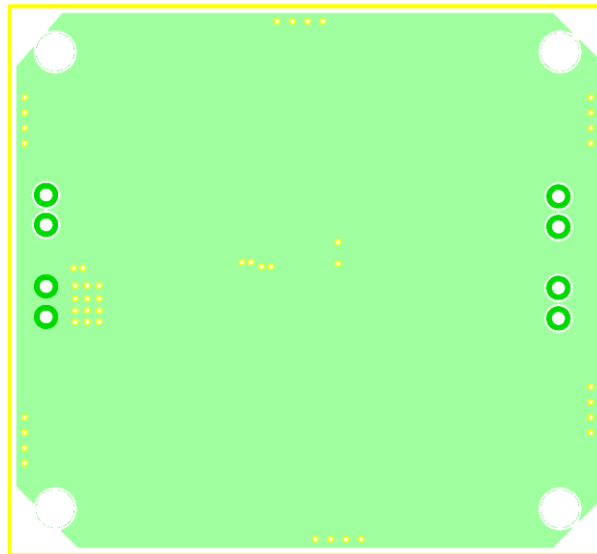

Figure 3—Bottom Layer

## QUICK START GUIDE

1. Connect the positive and negative terminals of the load to the LED+ and LED- pins on the EV board, respectively.
2. Preset the power supply output to 12V (for 2LED) and turn off the power supply.
3. Connect the positive terminal of the power supply output to the VIN pin and the negative terminal of the power supply output to the GND pin.
4. Turn on the power supply. The EVQ2489 will automatically start up.
5. The LED current is adjustable by set current sense resistor R1//R2.as below formula,

$$R1//R2=200mV/I_{LED}$$

**NOTICE:** The information in this document is subject to change without notice. Users should warrant and guarantee that third party Intellectual Property rights are not infringed upon when integrating MPS products into any application. MPS will not assume any legal responsibility for any said applications.