

DESCRIPTION

The EVM3509-QV-00A is an evaluation board for MPM3515, a synchronous rectified, step-down Mini-Module regulator with built-in power MOSFETS, inductor and two capacitors.

The Evaluation Board can deliver a 0.9A continuous output current with excellent load and line regulation over a wide input supply range.

Full protection features include over-current protection and thermal shut down.

The MPM3509 is available in a space-saving QFN-17 (3mmx5mmx1.6mm) package.

ELECTRICAL SPECIFICATION

Parameter	Symbol	Value	Units
Input Voltage	V _{IN}	4 -36	V
Output Voltage	V _{OUT}	3.3	V
Output Current	I _{OUT}	0.9	A

FEATURES

- Complete Switch Mode Power Supply
- 4V-to-36V Wide Operating Input Range
- 0.9A Continuous Load Current
- Low R_{DS(ON)} Internal Power MOSFETS
- Fixed 2.2MHz Switching Frequency
- 450kHz-2.2MHz Frequency Sync
- Forced CCM mode
- Power Good Indicator
- OCP Protection with Valley Current Detection and Hiccup
- Thermal Shutdown
- Output Adjustable from 0.8V
- Available in QFN-17 (3mmx5mmx1.6mm) Package
- Available in AEC-Q100 Grade 1

APPLICATIONS

- Industrial Controls
- Automotive
- Medical and Imaging Equipment
- Telecom Applications
- Distributed Power Systems

All MPS parts are lead-free, halogen free, and adhere to the RoHS directive. For MPS green status, please visit MPS website under Quality Assurance. "MPS" and "The Future of Analog IC Technology" are Registered Trademarks of Monolithic Power Systems, Inc.

EVM3509-QV-00A EVALUTION BOARD



(L x W x H) 6.35cm x 6.35cm x 0.3cm

Board Number	MPS IC Number
EVM3509-QV-00A	MPM3509GQV

Efficiency vs. Load Current

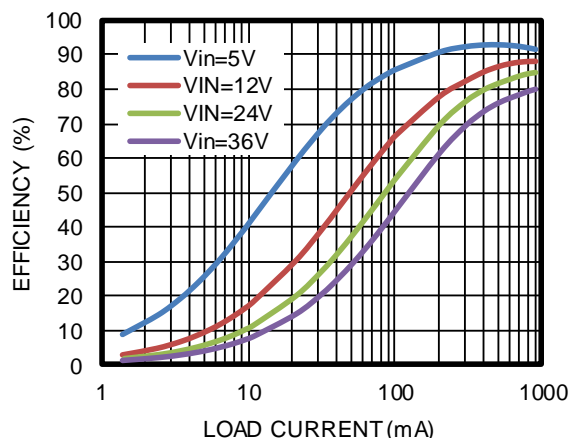

EVALUATION BOARD SCHEMATIC

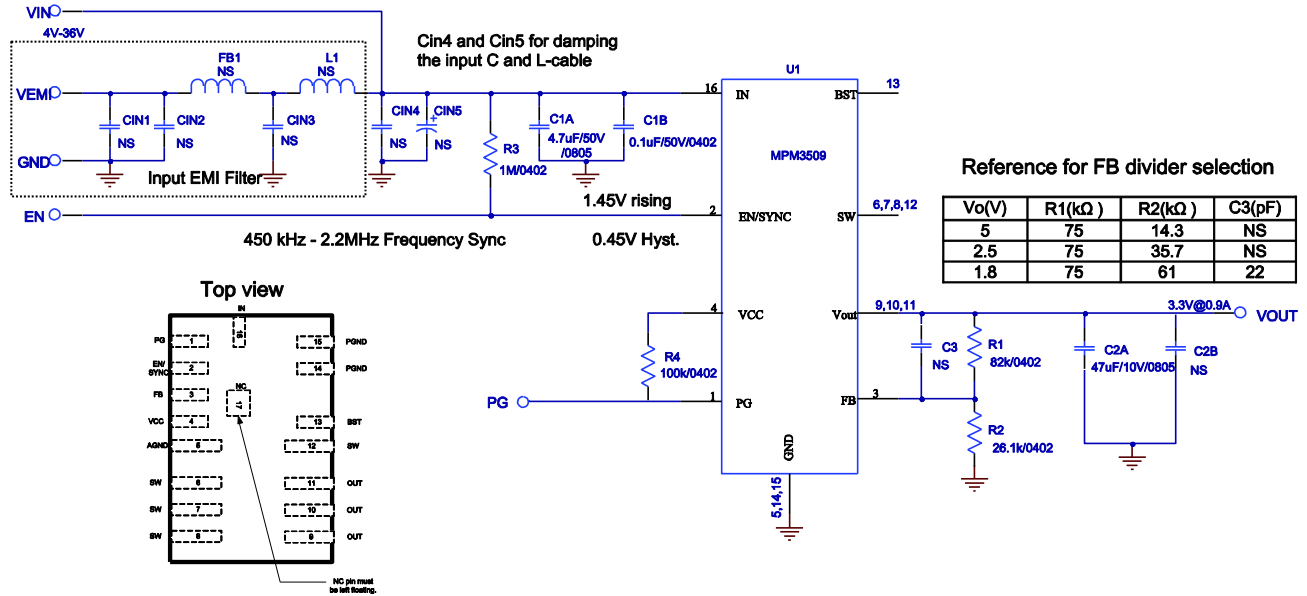

EVM3509-QV-00A BILL OF MATERIALS

Qty	RefDes	Value	Description	Package	Manufacturer	Manufacturer_P/N
1	C1A	4.7μF	Ceramic Cap., 50V, X7R	0805	muRata	GRM21BC71H475KE1
1	C1B	0.1μF	Ceramic Cap., 50V, X7R	0402	TDK	C1005X7R1C104K
1	C2A	47μF	Ceramic Cap., 10V, X5R	0805	muRata	GRM21BR61A476ME15L
7	C2B, CIN1, CIN2, CIN3, CIN4, CIN5, C3	NS				
1	R1	82k	Film Res., 1%	0402	Yageo	RC0402FR-0782KL
1	R2	26.1k	Film Res., 1%	0402	Yageo	RC0402FR-0726K1L
1	R3	1M	Film Res., 5%	0402	Yageo	RC0402JR-071ML
1	R4	100k	Film Res., 1%	0402	Yageo	RC0402FR-07100KL
1	FB1	NS				
1	L1	NS				
1	U1		module		MPS	MPM3509GQV

EVB TEST RESULTS

Performance waveforms are tested on the evaluation board.

$V_{IN} = 12V$, $V_{OUT} = 3.3V$, $T_A = 25^\circ C$, unless otherwise noted.

Steady State

$I_{OUT}=0A$

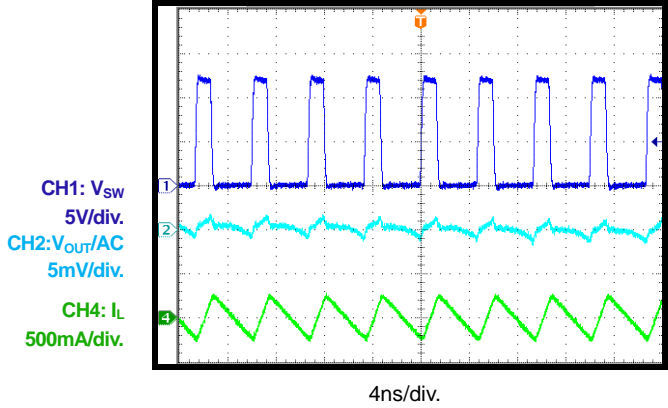

Steady State

$I_{OUT}=0.9A$

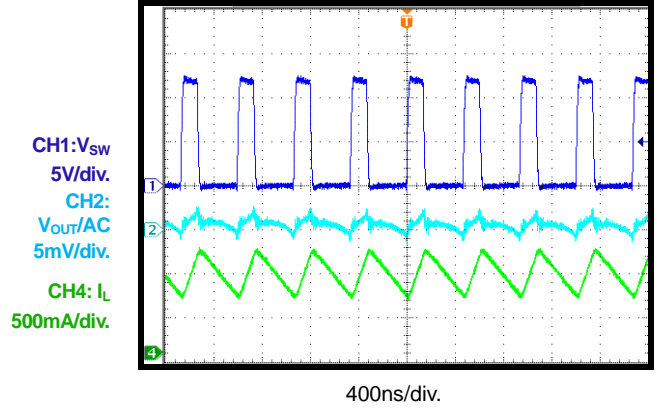

Power On

$I_{OUT}=0A$

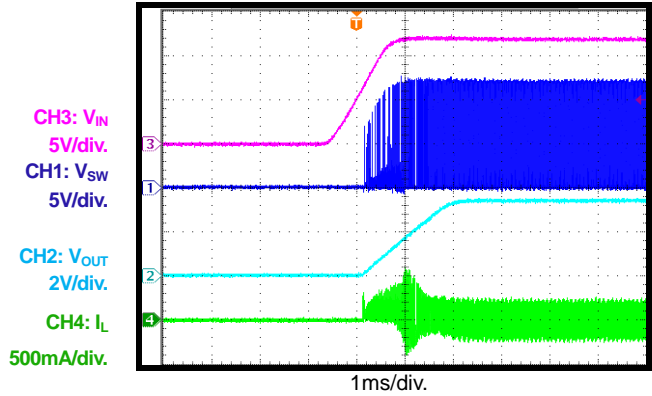

Power On

$I_{OUT}=0.9A$

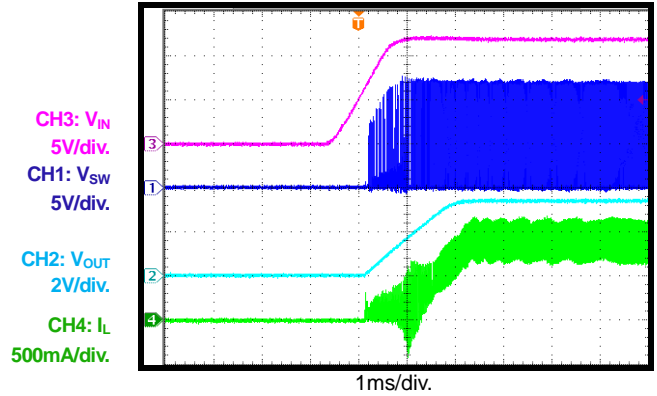

Power Off

$I_{OUT}=0A$

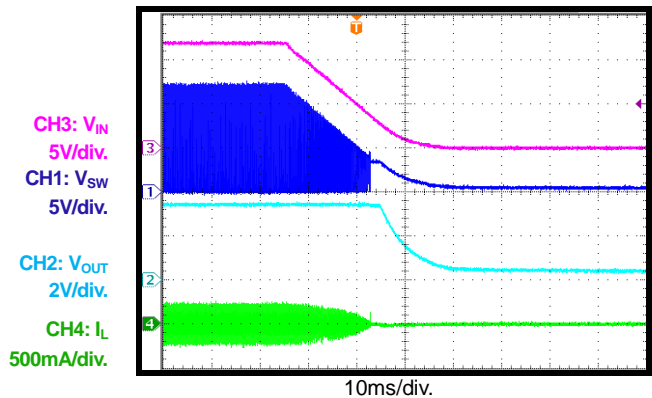

Power Off

$I_{OUT}=0.9A$

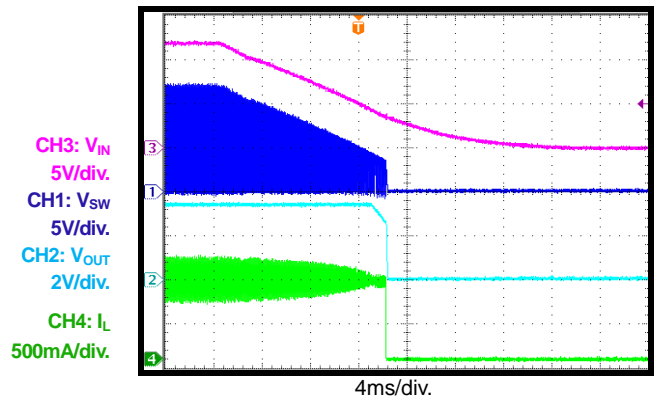

EVB TEST RESULTS

Performance waveforms are tested on the evaluation board.

$V_{IN} = 12V$, $V_{OUT} = 3.3V$, $T_A = 25^{\circ}C$, unless otherwise noted.

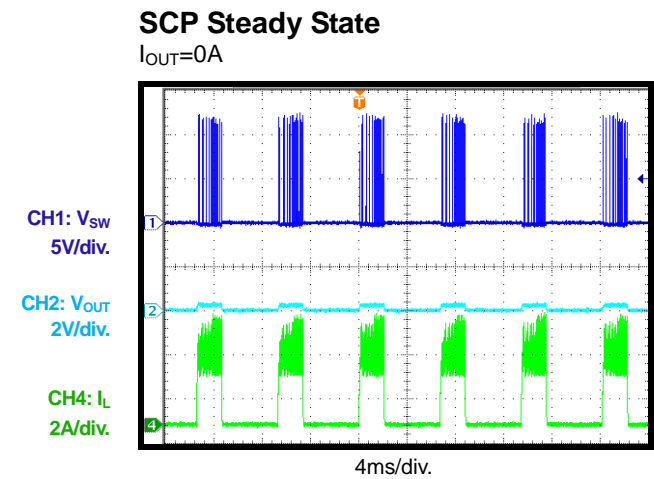
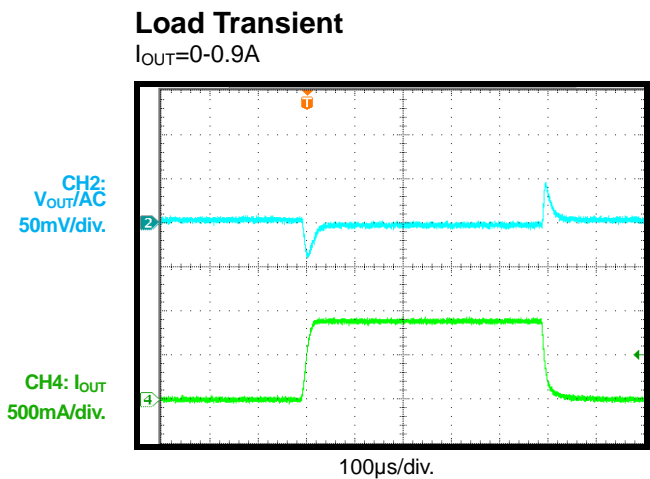
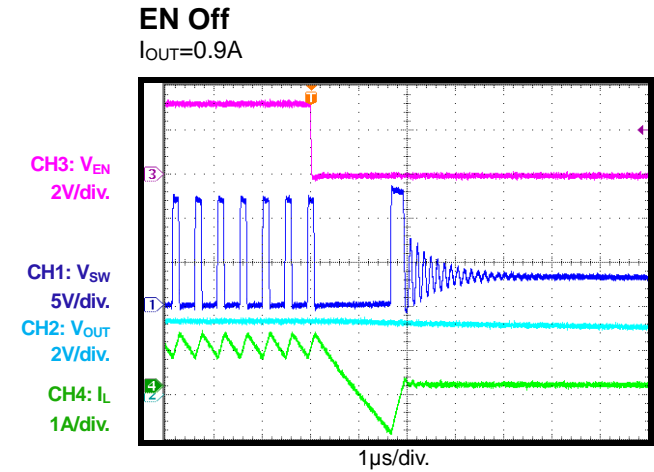
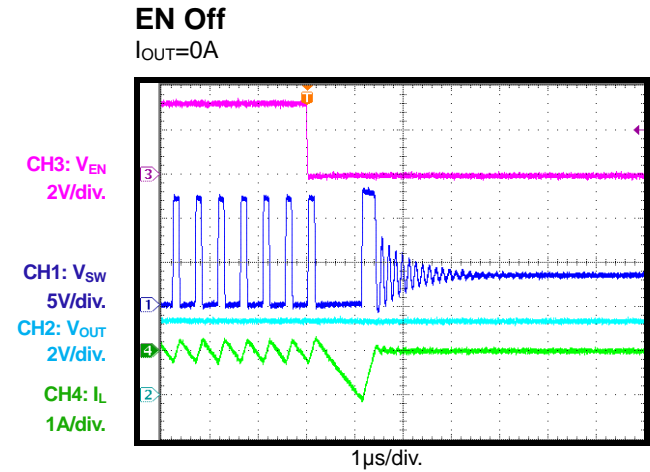
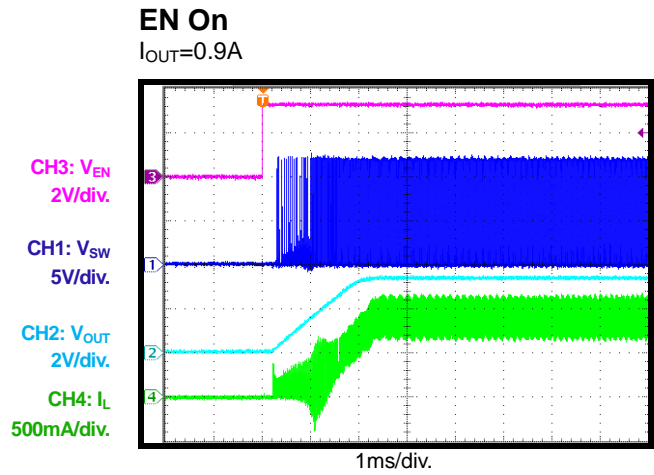
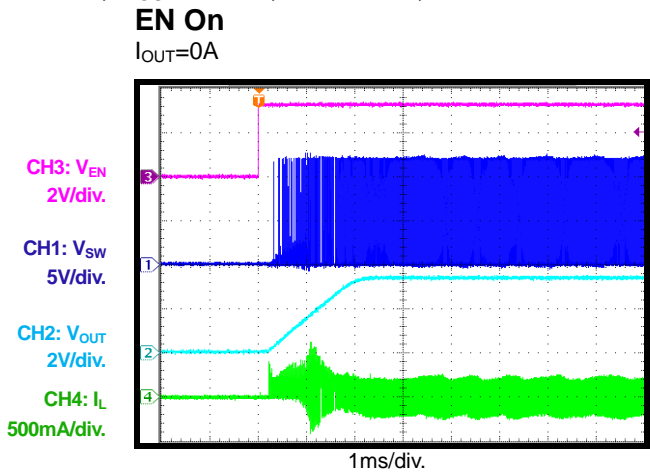

EVB TEST RESULTS

Performance waveforms are tested on the evaluation board.

$V_{IN} = 12V$, $V_{OUT} = 3.3V$, $T_A = 25^\circ C$, unless otherwise noted.

SCP Entry

$I_{OUT}=0A$

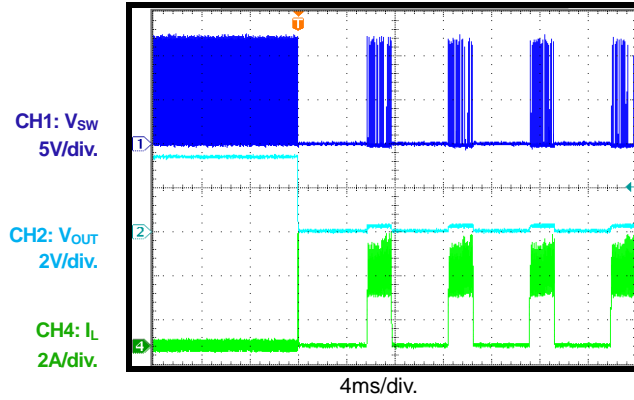

SCP Entry

$I_{OUT}=0.9A$

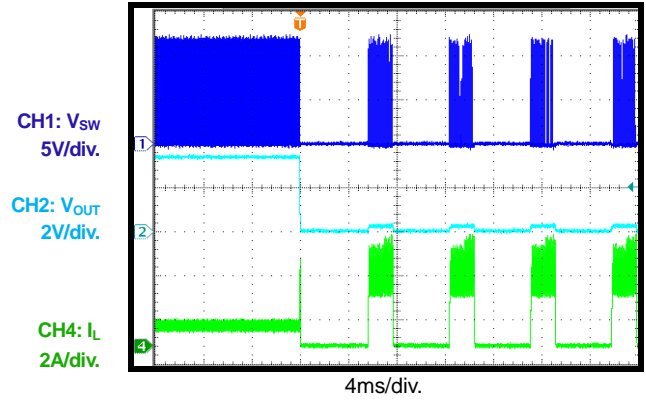

SCP Recovery

$I_{OUT}=0A$

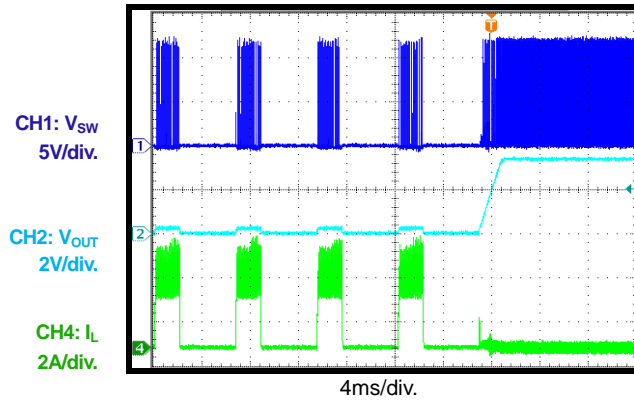

SCP Recovery

$I_{OUT}=0.9A$

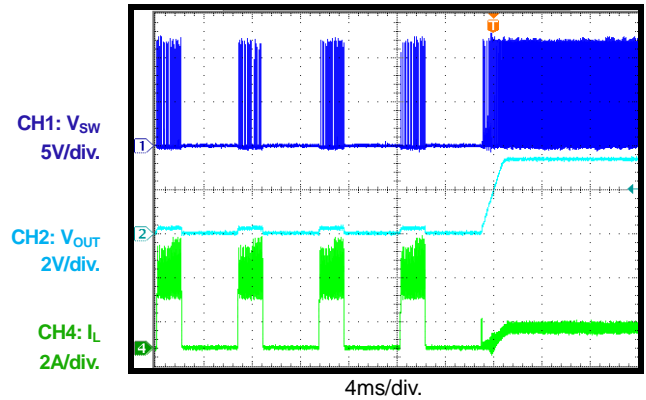

PRINTED CIRCUIT BOARD LAYOUT

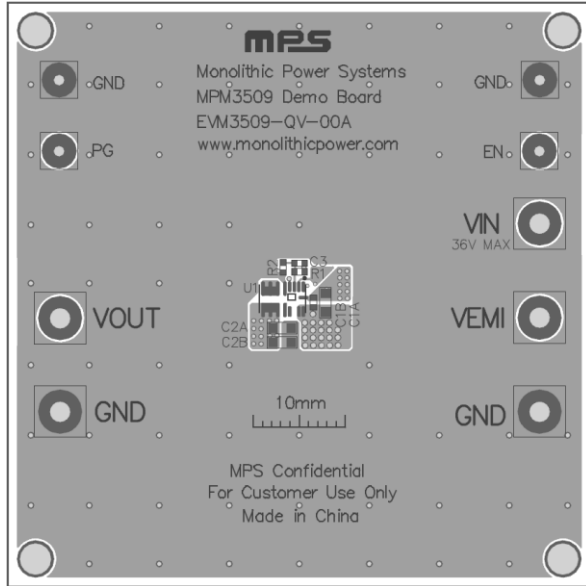

Figure 1-Top Silk Layer & Top layer

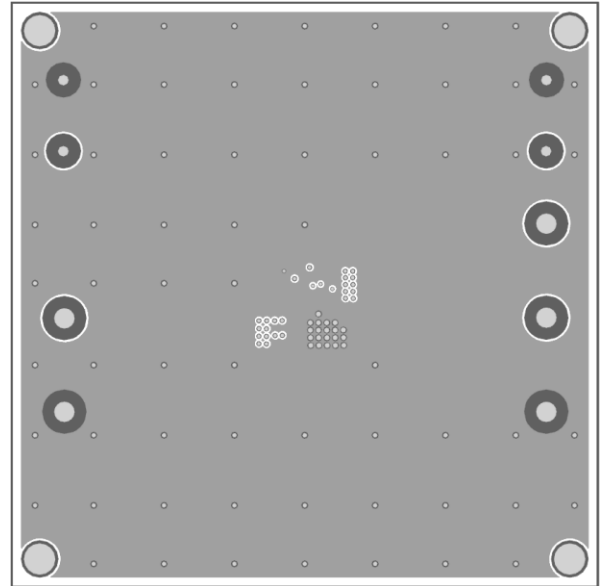

Figure 2-IN1 Layer

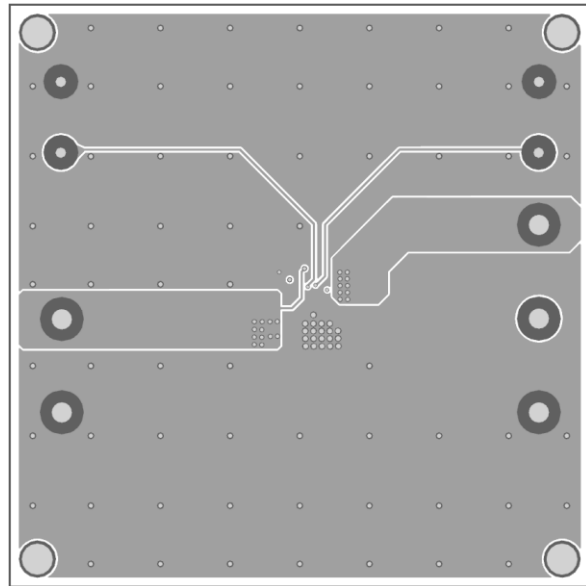

Figure 3-IN2 Layer

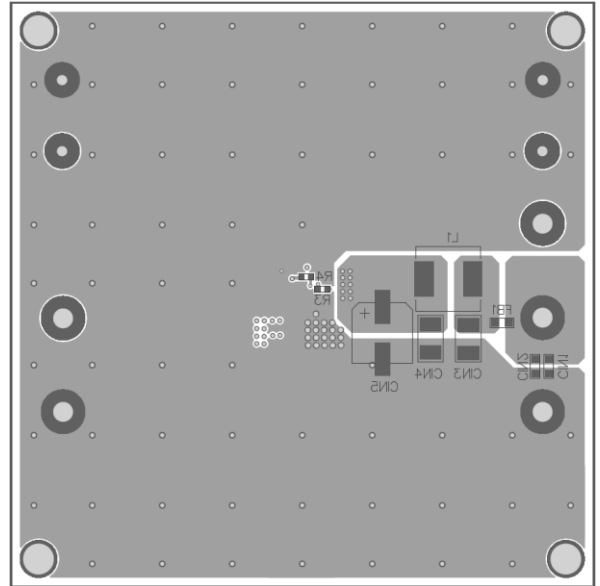

Figure 4-Bottom Silk Layer & Bottom Layer

QUICK START GUIDE

1. Connect the positive and negative terminals of the load to the VOUT and GND pins, respectively. Set load current between 0-0.9A. Be aware that electronic loads represent a negative impedance to the regulator and if set to a too high current will trigger over-current-protection or short-current-protection.
2. Preset the power supply output between 4V and 36V, and then turn off the power supply. If longer cables are used between the source and the EVB (>0.5m total), a damping capacitor should be installed at the input terminals, especially when $V_{IN} \geq 24V$.
3. Connect the positive and negative terminals of the power supply output to the VIN and GND pins, respectively.
4. Turn the power supply on. The board will automatically start up. The default V_{OUT} is 3.3V.
5. To get better EMI performance, add the EMI components at bottom layer of the board and connect the input power supply between VEMI and GND.
6. To use EN turning on/off MPM3509, remove R3 first. Then give a voltage between EN and GND higher than 1.45V to turn on, lower than 1V to turn off. To use the SYNC function, connect an external clock with a range of 450 kHz to 2.2MHz to synchronize the internal clock rising edge to the external clock rising edge.

APPLICATION INFORMATION

Setting the Output Voltage

The external resistor divider sets the output voltage. The feedback resistor R1 sets the feedback loop bandwidth with the internal compensation capacitor C3. Choose R1 to be around 75kΩ when $V_{OUT} \geq 1V$. R2 can then be calculated with Equation (1):

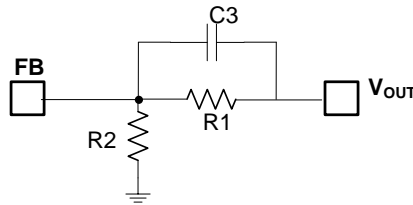

$$R2 = \frac{R1}{\frac{V_{OUT}}{0.807V} - 1} \quad (1)$$

NOTICE: The information in this document is subject to change without notice. Users should warrant and guarantee that third party Intellectual Property rights are not infringed upon when integrating MPS products into any application. MPS will not assume any legal responsibility for any said applications.