

DESCRIPTION

The EV8864-Q-00A is used for demonstrating the performance of MPS's MP8864. MP8864 is a highly integrated and high frequency synchronous step-down switcher with I²C control interface. It is optimized to support up to 4A load current over an input supply range from 4.5V to 21V with excellent load and line regulation.

Current-Mode operation provides fast transient response and eases loop stabilization. The output voltage level can be controlled, on-the fly through a 3.4Mbps I²C serial interface. Voltage range can be adjusted from 0.6V to 1.87V in 10mV steps. Voltage slew rate, switching frequency and power savings mode are also selectable through the I²C interface. Fully protection features includes over current protection, over voltage protection and over temperature protection.

MP8864 is available in QFN15 (3mmx3mm) package.

ELECTRICAL SPECIFICATION

Parameter	Symbol	Value	Units
Input Voltage	V _{IN}	4.5– 21	V
Output Voltage	V _{OUT}	1.2	V
Output Current	I _{OUT}	4	A

FEATURES

- Wide 4.5V-to-21V Operation Input Range
- 50mΩ/23mΩ Low R_{DS(ON)} Internal Power MOSFETs
- 1% V_{OUT} Accuracy
- I²C Programmable Output Range from 0.6V to 1.87V in 10mV Steps with Slew Rate Control
- I²C Selectable Switching Frequency. Default 600kHz Switching Frequency.
- Programmable Default Output Voltage
- Power Saving Mode, OTP and OCP Via I²C
- Power Good Indication
- 1 bit I²C Address Set pin
- OCP Protection and Hiccup
- External Soft Start
- Available in QFN3x3 Package

APPLICATIONS

- Flat-Panel Television and Monitors
- Digital Set-Top Boxes
- Distributed Power Systems

All MPS parts are lead-free, halogen free, and adhere to the RoHS directive. For MPS green status, please visit MPS website under Quality Assurance.

"MPS" and "The Future of Analog IC Technology" are Registered Trademarks of Monolithic Power Systems, Inc.

EV8864-Q-00A EVALUATION BOARD



Board Number	MPS IC Number
EV8864-Q-00A	MP8864GQ

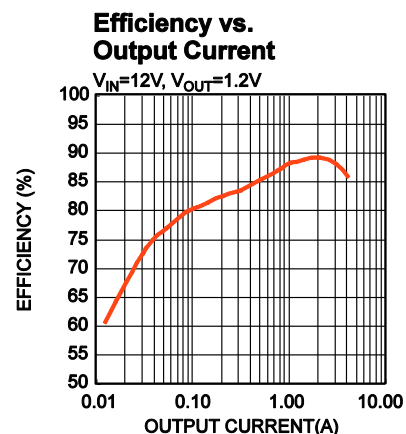

EVALUATION BOARD SCHEMATIC

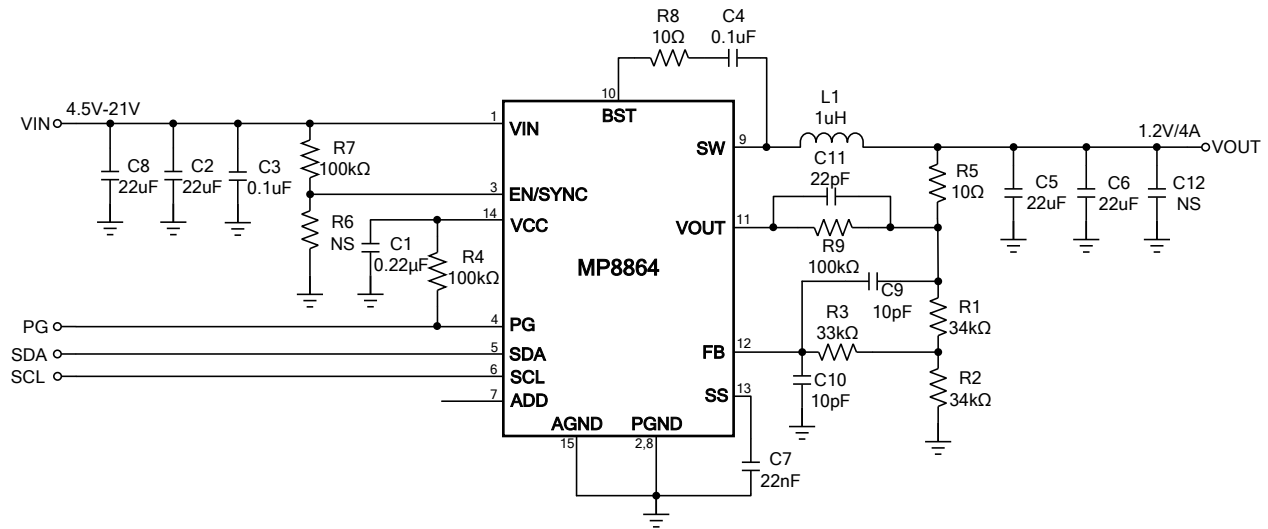

EV8864-Q-00A BILL OF MATERIALS

Qty	RefDes	Value	Description	Package	Manufacturer	Manufacturer P/N
1	C1	0.22μF	Ceramic Cap., 16V, X7R	0603	muRata	GRM188R71C224KA01D
2	C2,C8	22μF	Ceramic Cap., 25V, X5R	1206	muRata	GRM31CR61E226KE15L
2	C3,C4	0.1μF	Ceramic Cap., 25V, X7R	0603	muRata	GRM188R71E104KA01D
2	C5,C6	22μF	Ceramic Cap., 10V, X7R	1206	muRata	GRM31CR71A226KE15L
1	C7	22nF	Ceramic Cap., 50V, X7R	0603	muRata	GRM188R71H223KA01D
2	C9,C10	10pF	Ceramic Cap., 50V, C0G	0603	muRata	GRM1885C1H100JA01D
1	C11	22pF	Ceramic Cap., 50V, C0G	0603	muRata	GRM1885C1H220JA01D
0	C12	NS				
1	R1	34k	Thick Film Res., 1%	0603	Yageo	9C06031A3402FKHFT
1	R2	34k	Thick Film Res., 1%	0603	Yageo	9C06031A3402FKHFT
1	R3	33k	Thick Film Res., 1%	0603	Yageo	9C06031A3302FKHFT
3	R4,R7,R9	100k	Thick Film Res., 1%	0603	Yageo	9C06031A1003FKHFT
2	R5,R8	10Ω	Thick Film Res., 5%	0603	Yageo	9C06031A10R0JLHFT
0	R6	NS				
1	L1	1μH	Inductor, DCR=4.6mΩ, Is=19A	6.9x6.9x3.8mm	Wurth	744311100
1	U1	MP8864GQ	Synchronous Step-Down Convert	QFN3*3	MPS	MP8864GQ

EVB TEST RESULTS

Performance waveforms are tested on the evaluation board.

$V_{IN} = 12V$, $V_{OUT} = 1.2V$, $L = 1\mu H$, $T_A = 25^\circ C$, unless otherwise noted.

Efficiency vs. Output Current

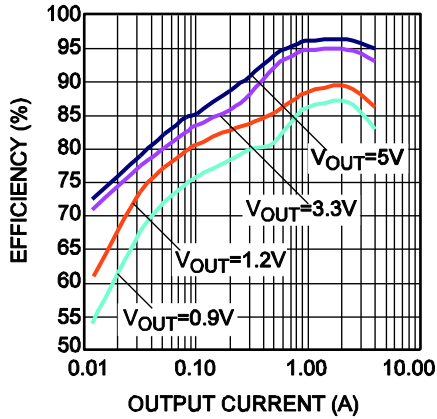

Case Temperature Rise vs. Output Current

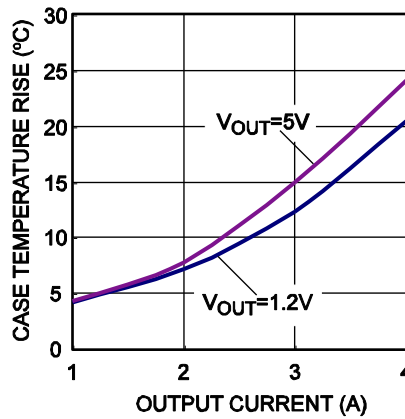

Load Regulation

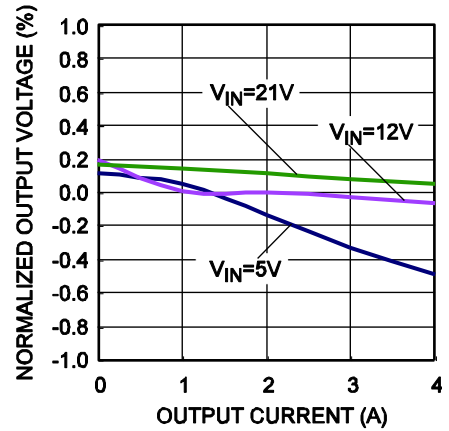

Line Regulation
 $V_{IN} = 5V-21V$

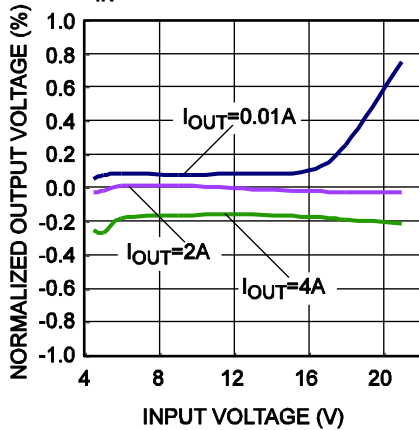

EVB TEST RESULTS *(continued)*

Performance waveforms are tested on the evaluation board.

$V_{IN} = 12V$, $V_{OUT} = 1.2V$, $L = 1\mu H$, $T_A = 25^\circ C$, unless otherwise noted.

Short Entry

$I_{OUT} = 0A$

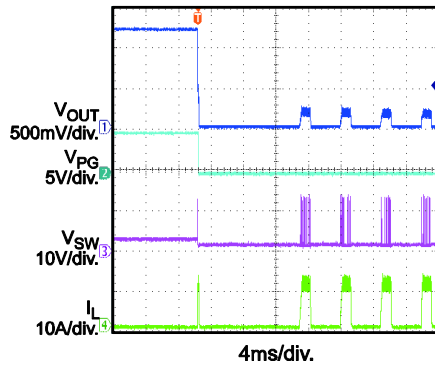

Short Recovery

$I_{OUT} = 0A$

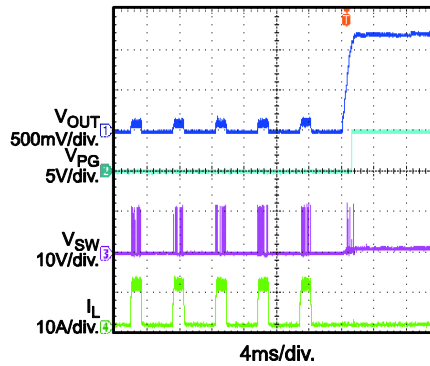

Start-Up through Enable

$I_{OUT} = 0A$

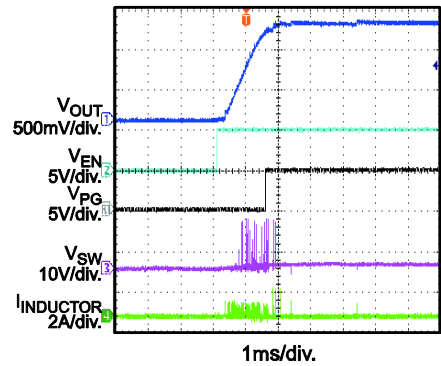

Start-Up through Enable

$I_{OUT} = 4A$

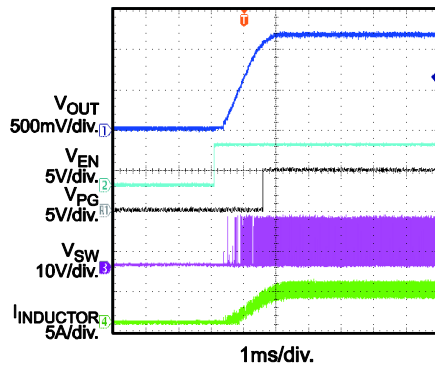

Shutdown through Enable

$I_{OUT} = 0A$

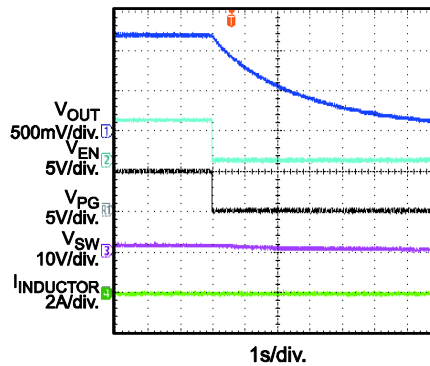

Shutdown through Enable

$I_{OUT} = 4A$

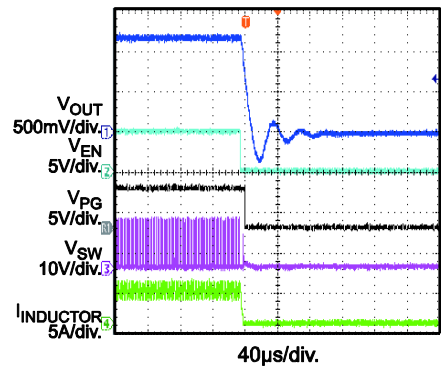

Start-Up through Input Voltage

$I_{OUT} = 0A$

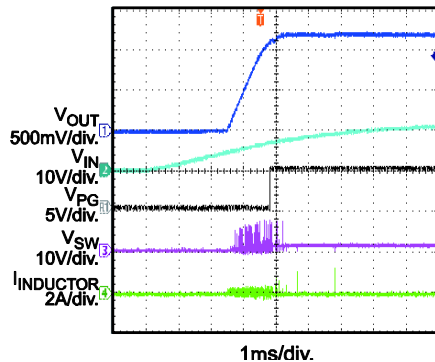

Start-Up through Input Voltage

$I_{OUT} = 4A$

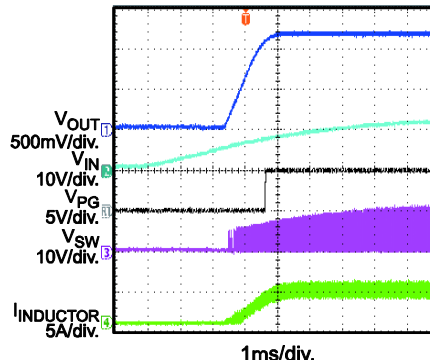

Shutdown through Input Voltage

$I_{OUT} = 0A$

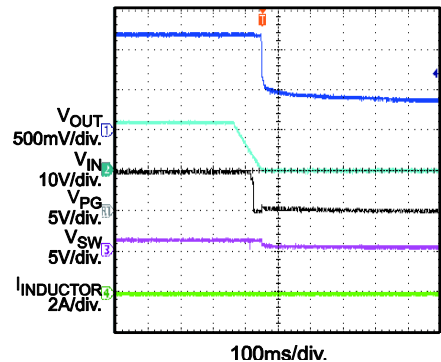

EVB TEST RESULTS *(continued)*

Performance waveforms are tested on the evaluation board.

V_{IN} = 12V, V_{OUT} = 1.2V, L = 1μH, T_A = 25°C, unless otherwise noted.

Shutdown through Input Voltage

I_{OUT} = 4A

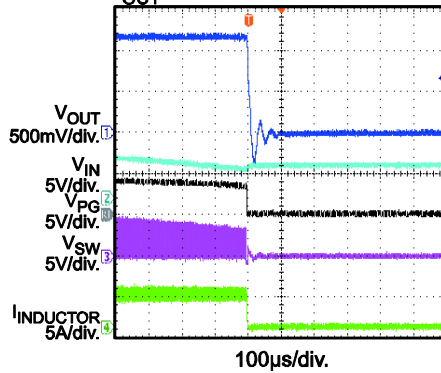

Input/Output Ripple

I_{OUT} = 4A

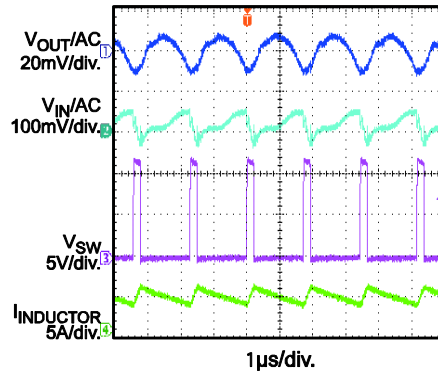

Input/Output Ripple

I_{OUT} = 0A

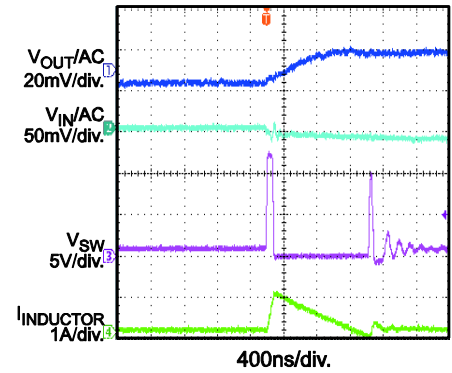

Load Transient Response

I_{OUT} = 2A to 4A

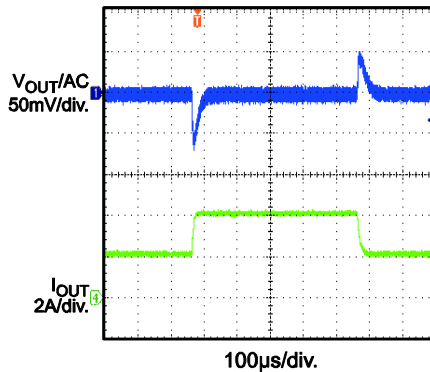

I²C Control Slew Rate

Slew rate=16mV/μs, I_{OUT} = 0A, from 0.9V to 1.2V

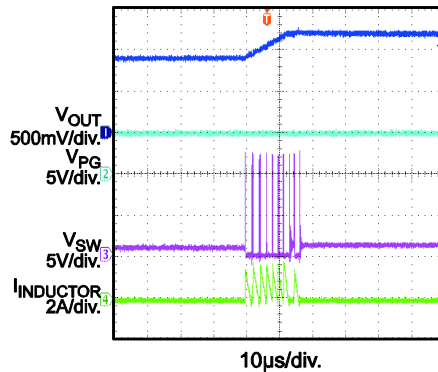

I²C Control Slew Rate

Slew rate=16mV/μs, I_{OUT} = 0A, from 1.2V to 0.9V

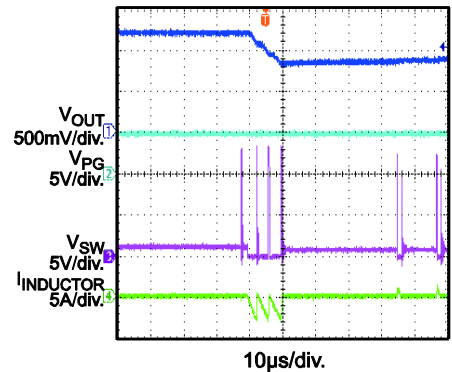

I²C Control Slew Rate

Slew rate=16mV/μs, I_{OUT} = 2A, from 0.9V to 1.2V

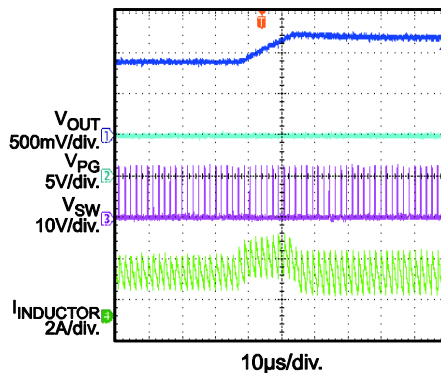

I²C Control Slew Rate

Slew rate=16mV/μs, I_{OUT} = 2A, from 1.2V to 0.9V

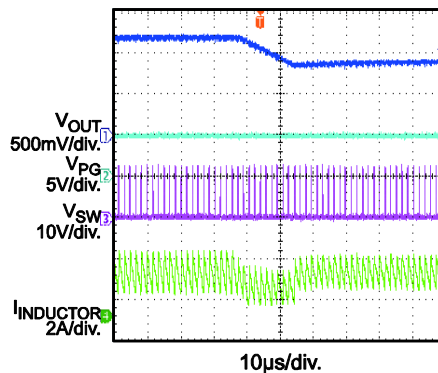

PRINTED CIRCUIT BOARD LAYER

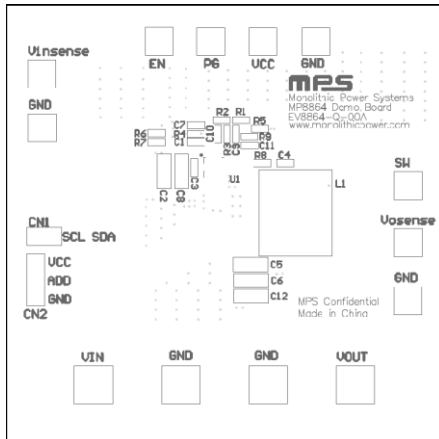

Figure 1: Top Silk Layer

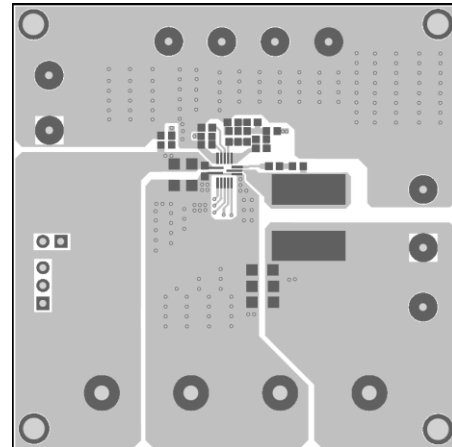

Figure 2: Top Layer

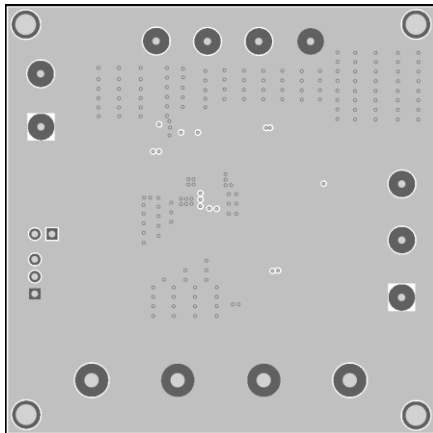

Figure 3: Inner 1 Layer

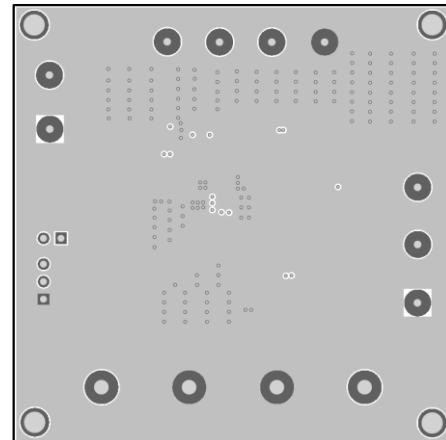

Figure 4: Inner 2 Layer

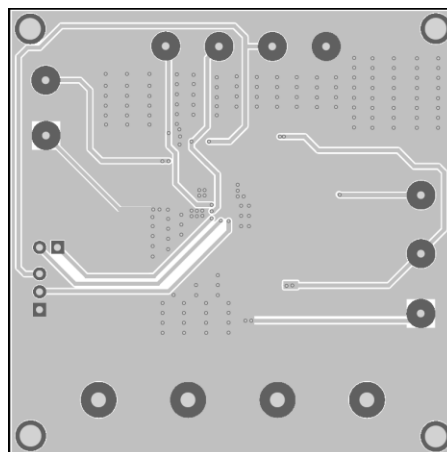

Figure 5: Bottom Layer

QUICK START GUIDE

1. Connect the positive and negative terminals of the load to the VOUT and GND pins, respectively.
2. Preset the power supply output between 4.5V and 21V, and then turn off the power supply.
3. Connect the positive and negative terminals of the power supply output to the VIN and GND pins, respectively.
4. Turn the power supply on. The board will automatically start up.
5. To use the Enable function, apply a digital input to the EN pin. Drive EN higher than 1.4V to turn on the regulator, or less than 1.25V to turn it off.
6. To program I2C function, connect SCL, SDA and GND to I2C start kit board. Connect I2C start kit board to computer and run MP8864 GUI software to program MP8864 I2C register.

NOTICE: The information in this document is subject to change without notice. Please contact MPS for current specifications. Users should warrant and guarantee that third party Intellectual Property rights are not infringed upon when integrating MPS products into any application. MPS will not assume any legal responsibility for any said applications.