

DESCRIPTION

The EV8712-L-00A is used for demonstrating the performance of MPS's MP8712. MP8712 is a highly integrated and high frequency synchronous step-down switch-mode converter. It offers a fully integrated solution to achieve a 12A continuous and 15A peak output current with excellent load and line regulation over a wide input supply range.

COT control operation provides fast transient response and eases loop stabilization. An open drain power good pin indicates that the output voltage is in the nominal range. Full protection features include over voltage, over-current protection and thermal shut down.

The MP8712 is available in QFN-14(3mmx4mm) package.

ELECTRICAL SPECIFICATION

Parameter	Symbol	Value	Units
Input Voltage	V _{IN}	3– 18	V
Output Voltage	V _{OUT}	1	V
Continuous Output Current	I _{OUT}	12	A
Peak Output Current	I _{OUT}	15	A

FEATURES

- Wide 3V-to-18V Operating Input Range
- 12A Continuous/15A Peak Output Current
- 1% Internal Reference Accuracy
- Output Adjustable from 0.6V
- 15mΩ/4.5mΩ High Side/Low Side R_{DS(ON)} for Internal Power MOSFETs
- 500kHz Switching Frequency
- External Soft Start
- Open Drain Power Good Indication
- Output Over Voltage Protection
- Hiccup OCP Protection
- Thermal Shutdown
- QFN-14(3mmx4mm) Package

APPLICATIONS

- Solid State Driver (SSD)
- Flat-Panel Television and Monitors
- Set-Top Boxes
- Distributed Power Systems

All MPS parts are lead-free, halogen free, and adhere to the RoHS directive. For MPS green status, please visit MPS website under Quality Assurance.

"MPS" and "The Future of Analog IC Technology" are Registered Trademarks of Monolithic Power Systems, Inc.

EV8712-L-00A EVALUATION BOARD

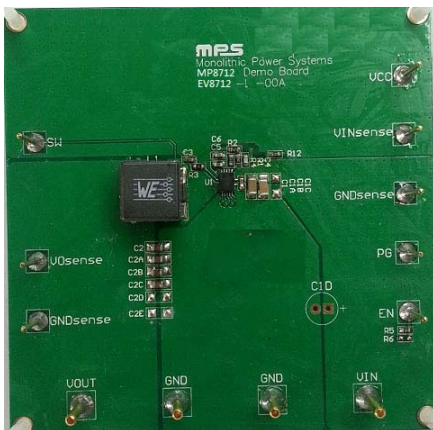

(4 layer PCB, 8.5cmx8.5cm)

Board Number	MPS IC Number
EV8712-L-00A	MP8712GL

Efficiency vs. Output Current
V_{OUT}=1V, L=1.5μH, DCR=2.1mΩ

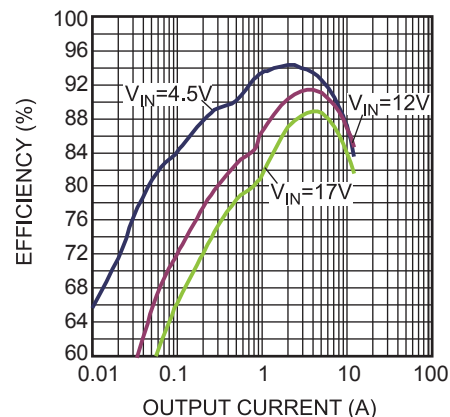

EVALUATION BOARD SCHEMATIC

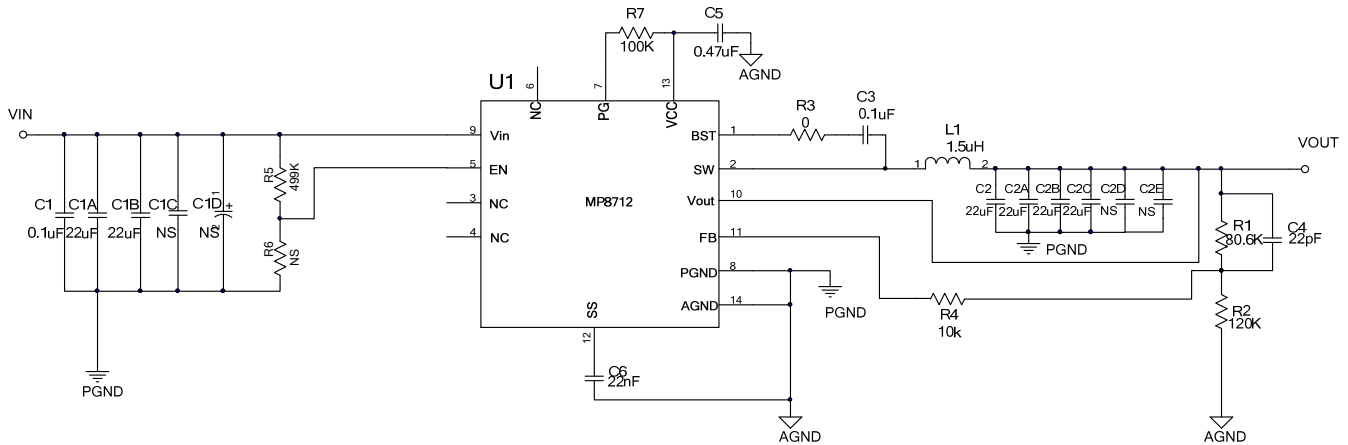

EV8712-L-00A BILL OF MATERIALS

Qty	Ref	Value	Description	Package	Manufacturer	Manufacturer P/N
1	R1	80.6k	Film Res,1%	0603	ROYAL	RC0603FR-0780K6L
1	R2	120k	Film Res,1%	0603	ROYAL	RL0603FR-07120KL
1	R3	0 Ω	Film Res,1%	0603	ROYAL	RC0603FR-070RL
1	R4	10k	Film Res,1%	0603	ROYAL	RL0603FR-0710KL
1	R5	499k	Film Res,1%	0603	ROYAL	RL0603FR-07499KL
0	R6	NS				
1	R7	100k	Film Res,1%	0603	ROYAL	RL0603FR-07100KL
2	C1, C3	0.1µF	Ceramic Cap, 25V, X7R	0603	muRata	GRM188R71E104KA01D
2	C1A,C1B,	22µF	Ceramic Cap,25V, X5R	1206	muRata	GRM31CR61E226KE15L
4	C2,C2A, C2B,C2C	22µF	Ceramic Cap , 25V, X5R	0805	muRata	GRM21BR61E226ME44L
0	C1C,C1D, C2D,C2E	NS				
1	C4	22pF	Ceramic Cap, 50V, X7R	0603	muRata	GRM1885C1H220JA01D
1	C5	0.47µF	Ceramic Cap,16V, X7R	0603	muRata	GRM188R71C474KA88D
1	C6	22nF	Ceramic Cap,16V, X7R	0603	muRata	GRM188R71C223KA01D
1	L1	1.5µH	Inductor, DCR=2.1mΩ	SMD	Würth	7443320150
1	U1	MP8712	Step-Down Converter	QFN14 (3*4)	MPS	MP8712GL

EVB TEST RESULTS

Performance waveforms are tested on the evaluation board.

$V_{IN} = 12V$, $V_{OUT} = 1V$, $L = 1.5\mu H$, $F_S = 500kHz$, $T_A = 25^\circ C$, unless otherwise noted.

Enabled Supply Current vs. Input Voltage

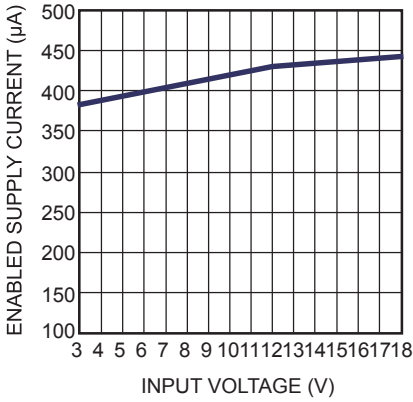

Disabled Supply Current vs. Input Voltage

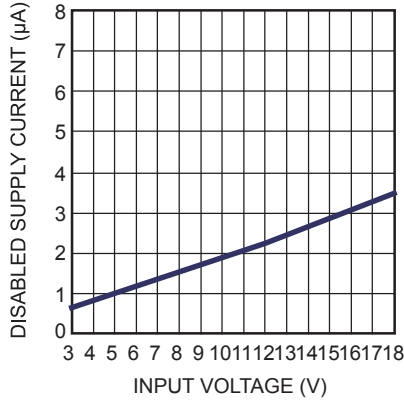

V_{IN} UVLO Rising vs. Temperature

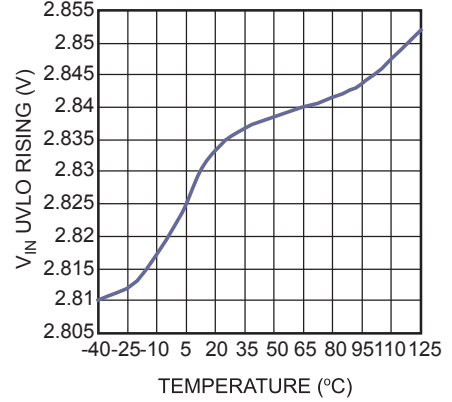

EN Rising Threshold vs. Temperature

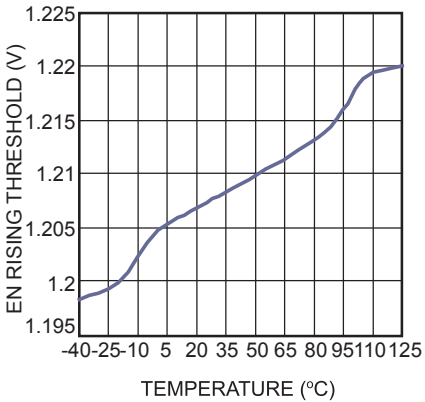

Reference Voltage vs. Temperature

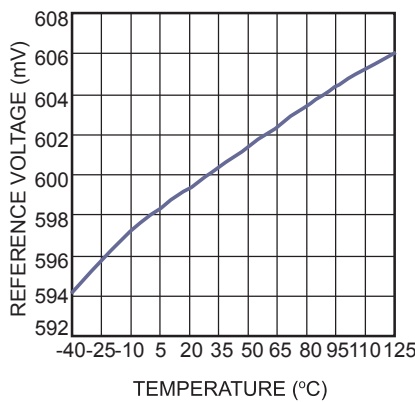

Line Regulation vs. Input Voltage

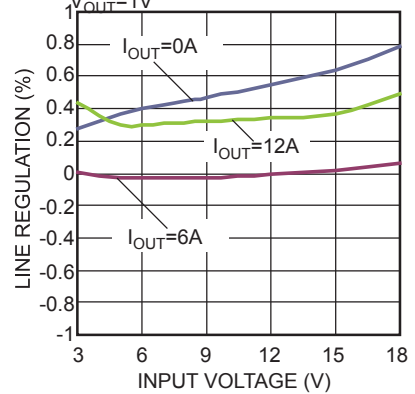

Efficiency vs. Output Current
 $V_{OUT} = 1V$, $L = 1.5\mu H$, $DCR = 2.1m\Omega$

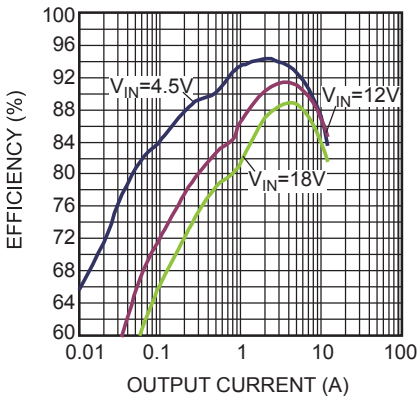

Efficiency vs. Output Current
 $V_{OUT} = 1.2V$, $L = 1.5\mu H$, $DCR = 2.1m\Omega$

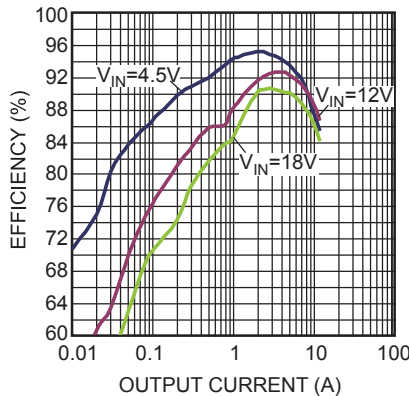

Efficiency vs. Output Current
 $V_{OUT} = 1.5V$, $L = 1.5\mu H$, $DCR = 2.1m\Omega$

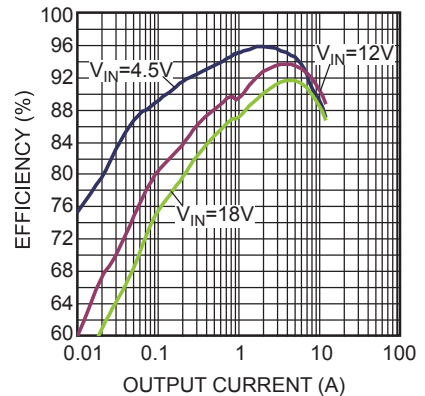

EVB TEST RESULTS (continued)

Performance waveforms are tested on the evaluation board.

 $V_{IN} = 12V$, $V_{OUT} = 1V$, $L = 1.5\mu H$, $F_S = 500kHz$, $T_A = 25^\circ C$, unless otherwise noted.

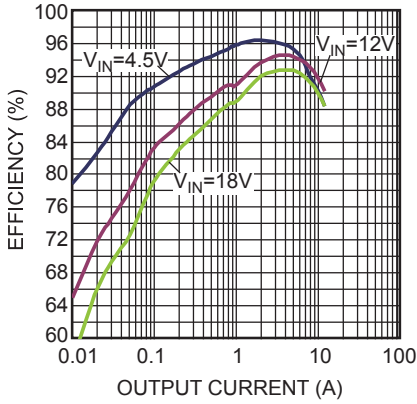
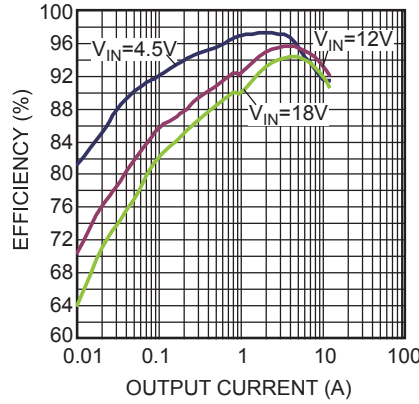
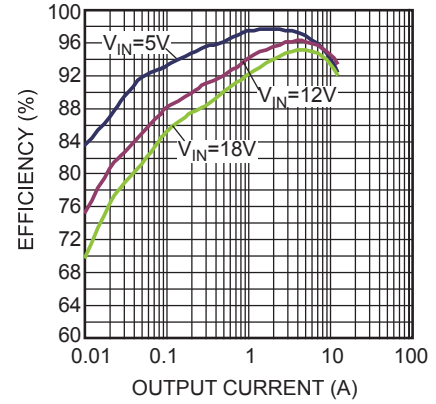
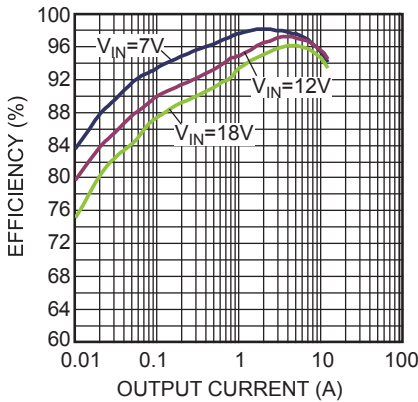
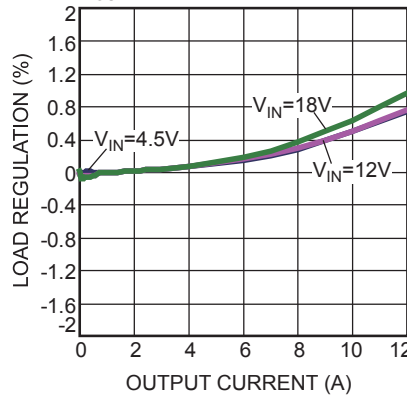
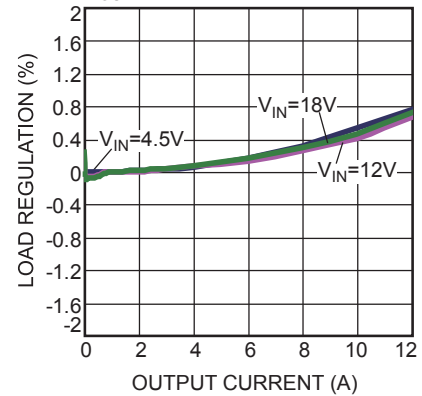
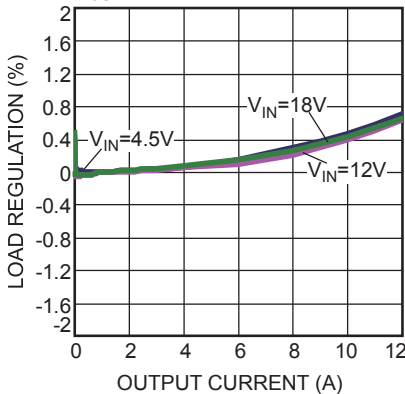
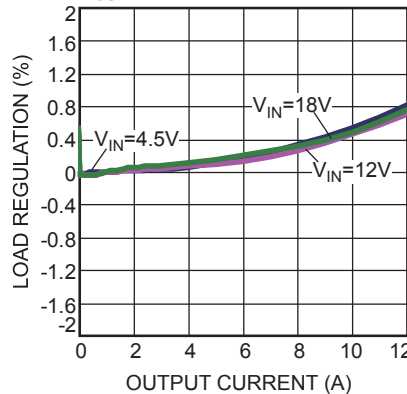
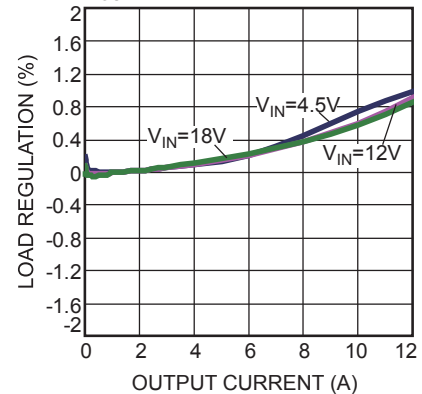
Efficiency vs. Output Current
 $V_{OUT}=1.8V$, $L=1.5\mu H$, $DCR=2.1m\Omega$

Efficiency vs. Output Current
 $V_{OUT}=2.5V$, $L=2.2\mu H$, $DCR=3m\Omega$

Efficiency vs. Output Current
 $V_{OUT}=3.3V$, $L=2.2\mu H$, $DCR=3m\Omega$

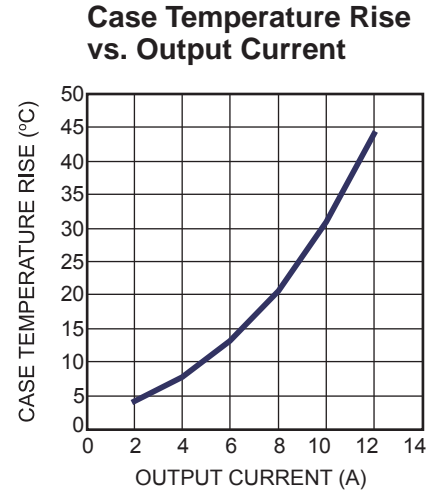
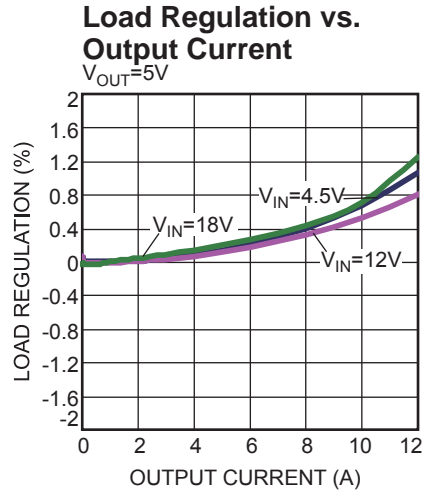
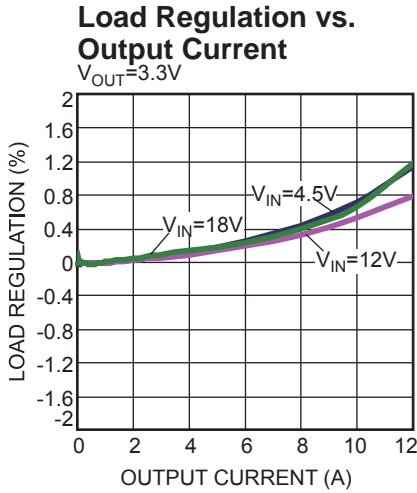
Efficiency vs. Output Current
 $V_{OUT}=5V$, $L=3.3\mu H$, $DCR=4.4m\Omega$

Load Regulation vs. Output Current
 $V_{OUT}=1V$

Load Regulation vs. Output Current
 $V_{OUT}=1.2V$

Load Regulation vs. Output Current
 $V_{OUT}=1.5V$

Load Regulation vs. Output Current
 $V_{OUT}=1.8V$

Load Regulation vs. Output Current
 $V_{OUT}=2.5V$

EVB TEST RESULTS (continued)

Performance waveforms are tested on the evaluation board.

 $V_{IN} = 12V$, $V_{OUT} = 1V$, $L = 1.5\mu H$, $F_S = 500kHz$, $T_A = 25^\circ C$, unless otherwise noted.

EVB TEST RESULTS (continued)

Performance waveforms are tested on the evaluation board.

 $V_{IN} = 12V$, $V_{OUT} = 1V$, $L = 1.5\mu H$, $F_S = 500kHz$, $T_A = 25^\circ C$, unless otherwise noted.

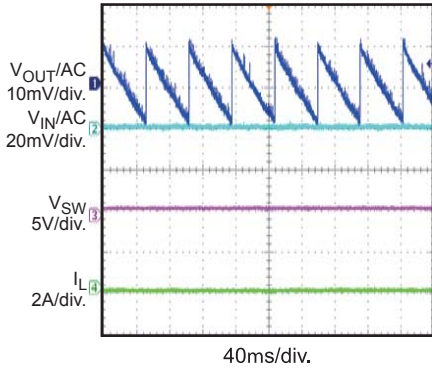
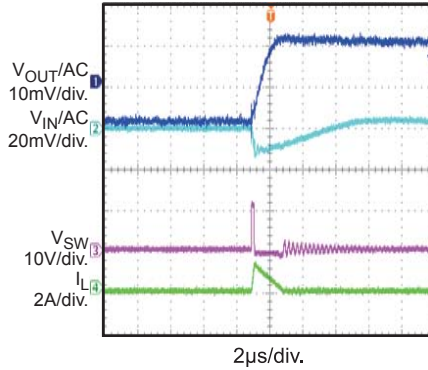
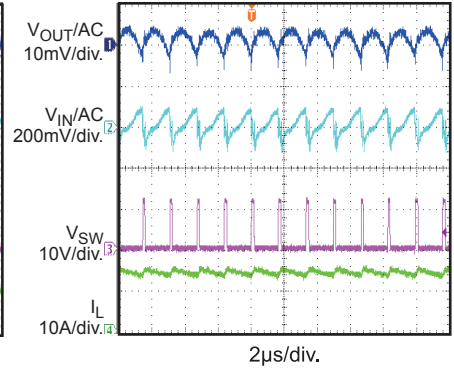
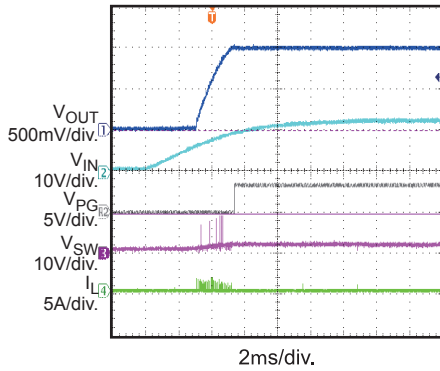
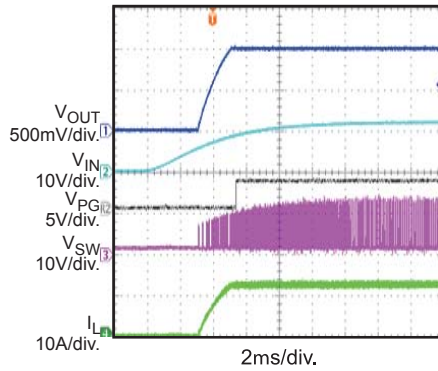
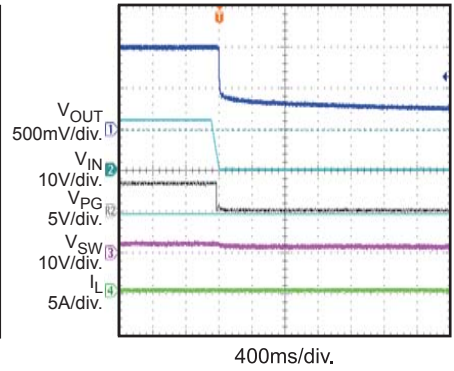
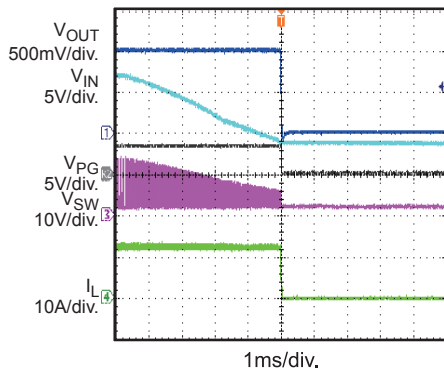
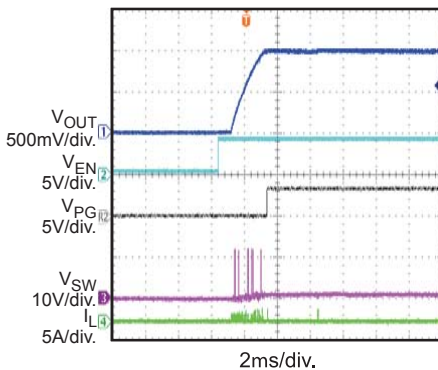
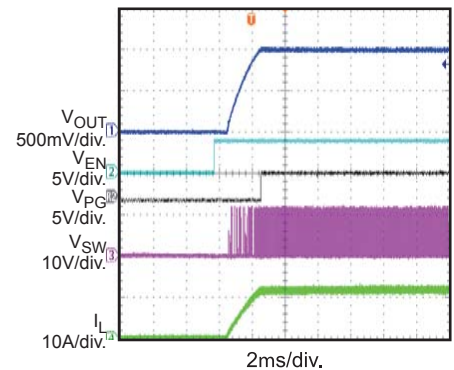
Input/Output Ripple
 $I_{OUT} = 0A$

Input/Output Ripple
 $I_{OUT} = 0A$

Input/Output Ripple
 $I_{OUT} = 12A$

Start-Up through Input Voltage
 $I_{OUT} = 0A$

Start-Up through Input Voltage
 $I_{OUT} = 12A$

Shutdown through Input Voltage
 $I_{OUT} = 0A$

Shutdown through Input Voltage
 $I_{OUT} = 12A$

Start-Up through EN
 $I_{OUT} = 0A$

Start-Up through EN
 $I_{OUT} = 12A$

EV8712-L-00A (continued)

Performance waveforms are tested on the evaluation board.

$V_{IN} = 12V$, $V_{OUT} = 1V$, $L = 1.5\mu H$, $F_S = 500kHz$, $T_A = 25^\circ C$, unless otherwise noted.

Shutdown through EN

$I_{OUT} = 0A$

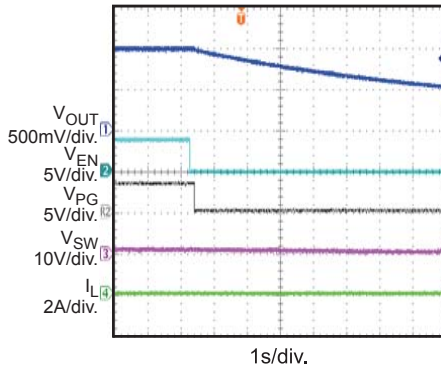

Shutdown through EN

$I_{OUT} = 12A$

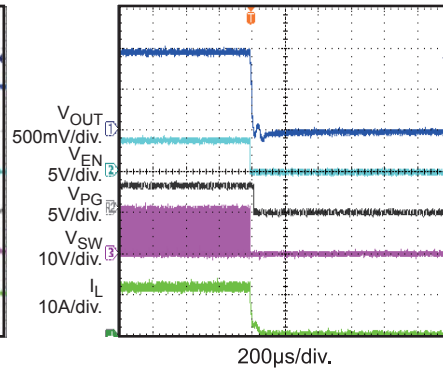

Load Transient

$I_{OUT} = 6A-12A$

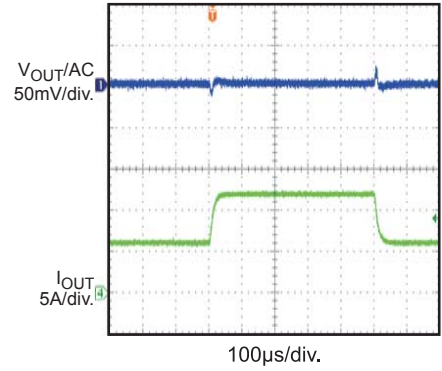

Short-Circuit Protection Entry

$I_{OUT} = 0A$

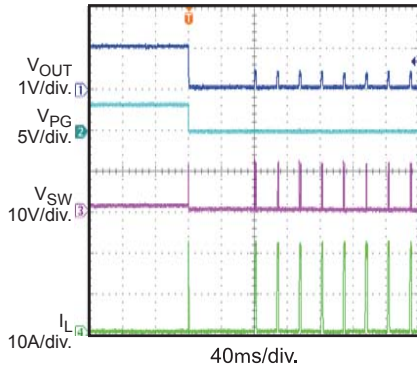

Short-Circuit Protection Recovery

$I_{OUT} = 0A$

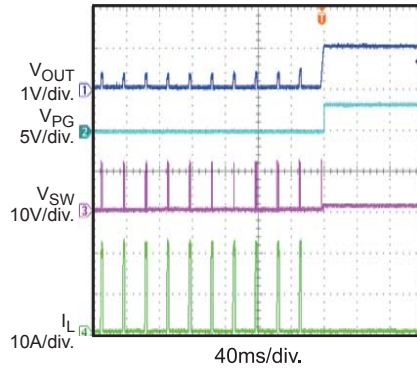

Short-Circuit Protection Steady State

Short Output to GND

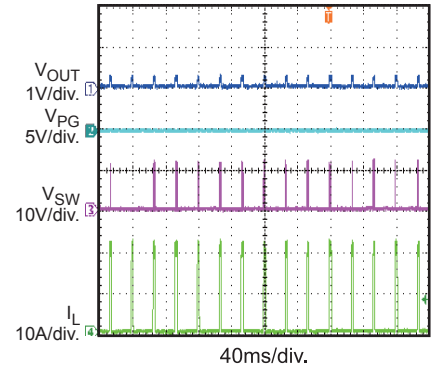

PRINTED CIRCUIT BOARD LAYER

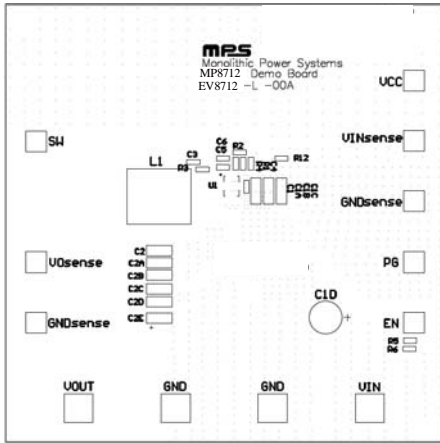

Figure 1: Top Silk Layer

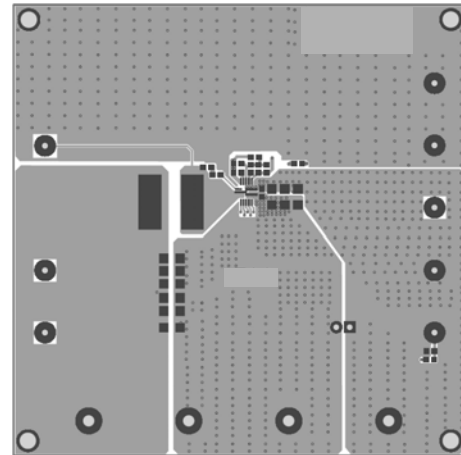

Figure 2: Top Layer

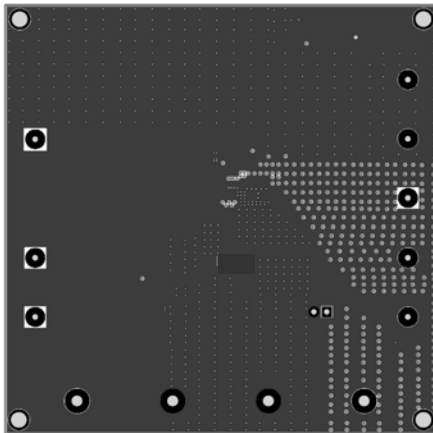

Figure 3: Inner 1 Layer

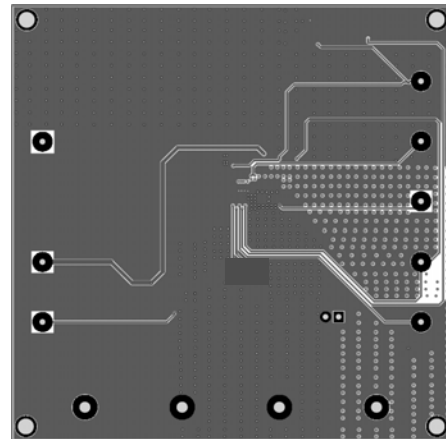

Figure 4: Inner 2 Layer

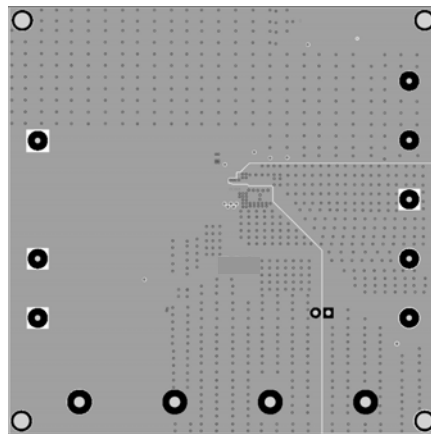

Figure 5: Bottom Layer

QUICK START GUIDE

1. Connect the positive and negative terminals of the load to the VOUT and GND pins, respectively.
2. Preset the power supply output between 3V and 18V, and then turn off the power supply.
3. Connect the positive and negative terminals of the power supply output to the VIN and GND pins, respectively.
4. Turn the power supply on. The board will automatically start up.
5. To use the Enable function, apply a digital input to the EN pin. Drive EN higher than 1.5V to turn on the regulator, or less than 1.0V to turn it off.

NOTICE: The information in this document is subject to change without notice. Please contact MPS for current specifications. Users should warrant and guarantee that third party Intellectual Property rights are not infringed upon when integrating MPS products into any application. MPS will not assume any legal responsibility for any said applications.