

## DESCRIPTION

EV8008-V-00A Evaluation Board is designed to demonstrate the capability of MP8008's function. The MP8008 is an integrated IEEE 802.3af/at PoE compliant Powered Device (PD) power supply converter. It includes PD interface and peak current mode flyback controller.

The PD interface has all the functions of IEEE 802.3af/at, and sets 120mA inrush current limit, 840mA operation current limit as well as 100V Hot-swap MOSFET.

The flyback PWM controller can drive an external MOSFET capable of handling more than 10A current. PSM function improves the efficiency in light load condition. The MP8008 flyback also features protection including over load, short output and over voltage protection.

The MP8008 can support a front-end solution for PoE-PD application, it is available in QFN-28 (4mmX5mm) package.

## ELECTRICAL SPECIFICATIONS

Parameter	Symbol	Value	Units
Input Voltage	$V_{DD}$	37-57	V
Adapter Voltage	$V_{ADAPTER}$	12	V
Output Voltage	$V_{OUT}$	12	V
Output Current	$I_{OUT}$	2.1	A

## FEATURES

- Compatible with 802.3af/at Specifications
- 100V 0.48Ω PD Integrated Pass Switch
- 120mA PD Inrush Current
- 840mA PD Operation Current Limit
- Auxiliary Adaptor ORing Power Supply
- PD Power Good and Type-2 PSE Indicator
- 1A 12V Flyback MOSFET Gate Driver
- Pulse Skipping Operation with Light Load
- Programmable Switching Frequency (30kHz-to-400kHz)
- Frequency Synchronizing from 80kHz-to-400kHz
- Cycle-by-Cycle Current Limit
- Over Load, Short Circuit, Over Voltage and Thermal Protection
- Available in QFN-28 (4mmx5mm) Package

## APPLICATIONS

- IEEE 802.3af/at-Compliant Devices
- Security Camera
- Video Telephone
- WLAN Access Points
- IOT Device

All MPS parts are lead-free, halogen free, and adhere to the RoHS directive. For MPS green status, please visit MPS website under Quality Assurance. "MPS" and "The Future of Analog IC Technology" are Registered Trademarks of Monolithic Power Systems, Inc.

## EV8008-V-00A EVALUATION BOARD



(L x W x H) (11.8cm x 4cm x 1.5cm)

Board Number	MPS IC Number
EV8008-V-00A	MP8008GV

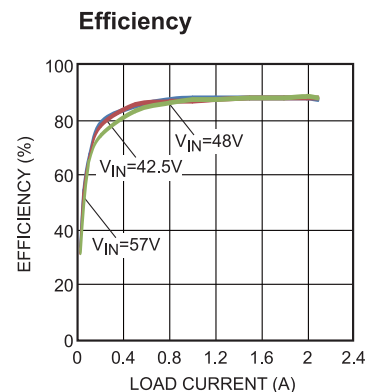

## EVALUATION BOARD SCHEMATIC

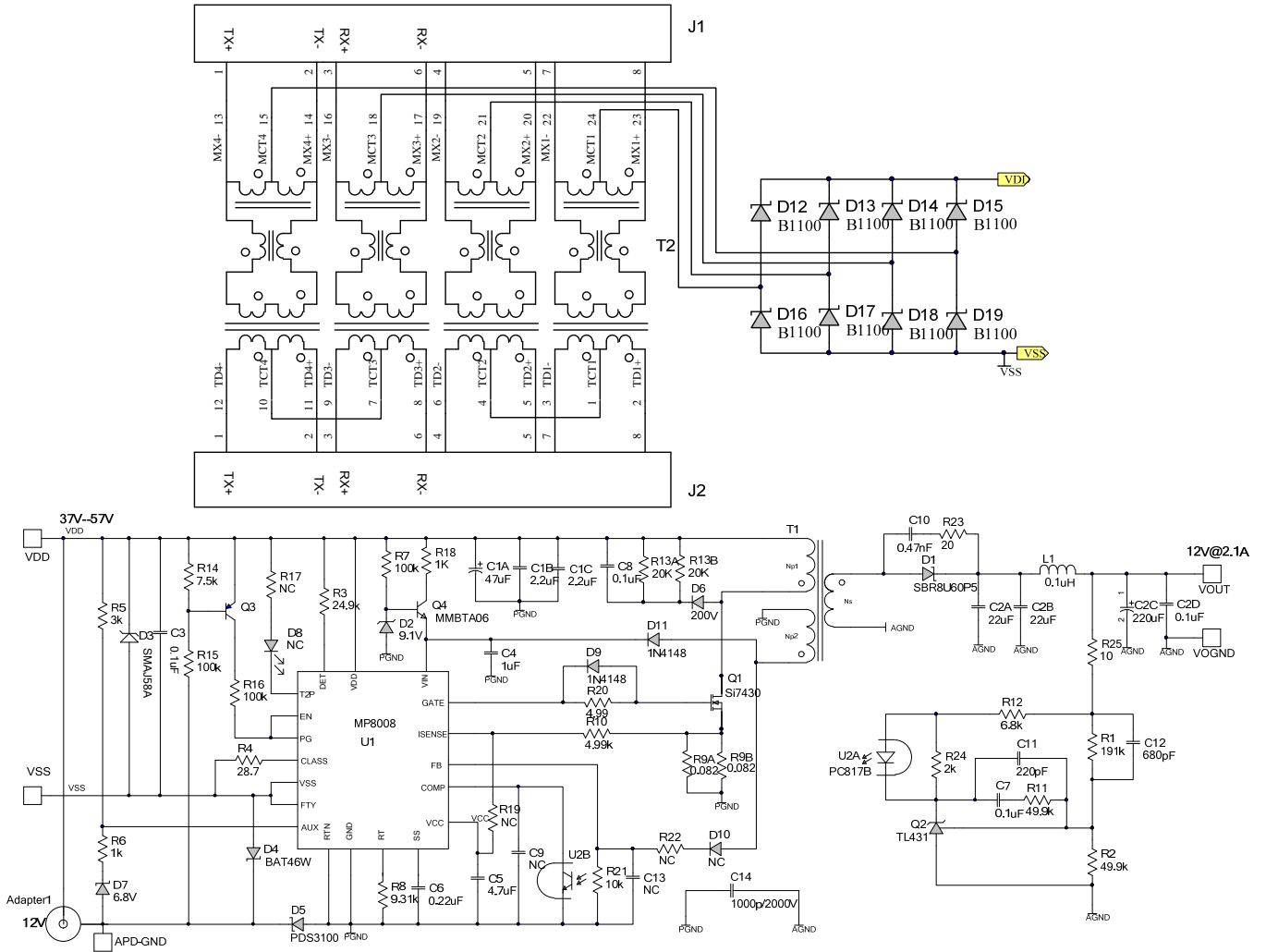

## EV8008-V-00A BILL OF MATERIALS

Qty	Ref	Value	Description	Package	Manufacturer	Part Number
1	C1A	47 $\mu$ F	47 $\mu$ F 100V CD284 E-Cap. 10X12.5mm	DIP	JiangHai	47 $\mu$ F/100V
2	C1B, C1C	2.2 $\mu$ F	Ceramic Cap.,100V, X7R	1210	muRata	GRM32ER72A225KA35L
2	C2A, C2B	22 $\mu$ F	Ceramic Cap.,25V,X7R	1210	muRata	GRM32ER71E226KE15L
1	C2C	220 $\mu$ F	220 $\mu$ F 25V CD284 E- Cap.,8X12.5mm	DIP	JiangHai	220uF/25V
2	C2D,C7	0.1 $\mu$ F	Ceramic Cap.,50V,X7R	0603	muRata	GRM188R71H104KA61D
1	C3	0.1 $\mu$ F	Ceramic Cap.,100V, X7R	1206	Murata	GRM319R72A104KA01D
1	C4	1 $\mu$ F	Ceramic Cap.,25V,X7R	0603	muRata	GRM188R71E105KA61D
1	C5	4.7 $\mu$ F	Ceramic Cap.,16V X7R	0805	muRata	GRM21BR71C475KA73L
1	C6	0.22 $\mu$ F	Ceramic Cap.,50V X7R	0603	muRata	GRM188R71H224KA93D
1	C8	0.1 $\mu$ F	Ceramic Cap.,100V X7R	0805	muRata	GRM21BR72A104KAC4 L
0	C9,C13	NS				
1	C10	470pF	Ceramic Cap.,100V,X7R	0603	muRata	GRM188R72A471KA01D
1	C11	220pF	Ceramic Cap.,50V X7R	0603	muRata	GRM188R71H221KA01D
1	C12	680pF	Ceramic Cap.,50V X7R	0603	muRata	GRM188R71H681KA01D
1	C14	1nF	Ceramic Cap.,2000V X7R	1808	muRata	GR442QR73D102KW01L
1	R1	191k	Film Res.,1%	0603	ROYAL	RC0603FR-07191KL
2	R2,R11	49.9k	Film Res.,1%	0603	ROYAL	RC0603FR-0749K9L
1	R3	24.9k	Film Res.,1%	0603	ROYAL	RC0603FR-0724K9L
1	R4	28.7	Film Res.,1%	0603	ROYAL	RC0603FR-0728R7L
1	R5	3k	Film Res.,1%	0603	ROYAL	RC0603FR-073KL
2	R6,R18	1k	Film Res.,1%	0603	ROYAL	RC0603FR-071KL
3	R7,R15, R16	100k	Film Res.,1%	0603	ROYAL	RC0603FR-07100KL
1	R8	9.31k	Film Res.,1%	0603	ROYAL	RC0603FR-079K31L
2	R9A, R9B	82m $\Omega$	Film Res.,1%	1206	CYNTEC	RL1632H-R080-FN
1	R10	4.99k	Film Res.,1%	0603	ROYAL	RC0603FR-074K99L
1	R12	6.8k	Film Res.,1%	0603	ROYAL	RC0603FR-076K8L
2	R13A, R13B	20k	Film Res.,5%	1206	ROYAL	RC1206JR-0720KL
1	R14	7.5k	Film Res.,1%	0603	ROYAL	RC0603FR-077K5L
0	R17, R19, R22	NS				
1	R20	4.99R	Film Res.,1%	0603	ROYAL	RC0603FR-074R99L
1	R21	10k	Film Res.,1%	0603	ROYAL	RC0603FR-0710KL

**EV8008-V-00A BILL OF MATERIALS (continued)**

Qty	Ref	Value	Description	Package	Manufacturer	Part Number
1	R23	20	Film Res.,5%	0805	ROYAL	RC0805JR-0720RL
1	R24	2k	Film Res.,1%	0603	ROYAL	RC0603FR-072KL
1	R25	10	Film Res.,1%	0603	ROYAL	RC0603FR-0710RL
1	D1	SBR8U60P5	Switching Diode 60V 8A	POWERDI5	Diodes Inc	SBR8U60P5
1	D2	9.1V	Diode Zener 9.1V	SOD-123	Diodes Inc	BZT52C9V1
1	D3	SMAJ58A	TVS	SMA	Littelfuse	SMAJ58A
1	D4	BAT46W	100V, DIODE	SOD-123	Diodes	BAT46W-7-F
1	D5	PDS3100	3A,100V, SCHOTTKY	POWERDI5	Diodes	PDS3100-13
1	D6	BAV21	Switching Diode 200V 200mW	SOD-123	Diodes Inc	BAV21W-7-F
1	D7	6.8V	Diode Zener 6.8V	SOD-123	Diodes Inc	BZT52C6V8
0	D8,D10	NS				
2	D9,D11	1N4148	Switching Diode 75V 250mW	SOD-323	Diodes Inc	1N4148WS-7
8	D12,D13,D14,D15,D16,D17,D18,D19	B1100	1A, 100V, SCHOTTKY	SMA	Diodes Inc	B1100
1	T1	Transformer	POWER STAGE TRANSFORMER	SMD	Würth	7491194912
1	T2	749020010A	LAN-Transformer WE-LAN	SMD	Würth	749020010A
1	Q1	SI7430	N-CH MOSFET 150V 26A	PowerPAK SO-8	Vishay	SI7430DP
1	Q2	TL431	REG VLT ADJ 2.5V	SOT-23	Zetex Inc	TL431
1	Q3	BSS63LT1G	PNP, 100V, 100mA	SOT-23	On Semiconductor	BSS63LT1G
1	Q4	MMBTA06	NPN, 80V, 500mA	SOT-23	Fairchild	MMBTA06FSTR-ND
2	J1,J2	RJ45-8N4-B	RJ Jack / Signal Line EMI/RFI Filters 6 TRMN BRD/CBLE GRND 8 PIN BLOCK INDUCTOR	RJ45-TAB	Tyco Electronics	RJ45-8N4-B
1	L1	0.1uH	IR=12A	SMD	Würth	744 373 240 010
1	U1	MP8008	PD interface and DC-DC Controller	QFN-28	MPS	MP8008GV
1	U2	PC817	Photo coupler	SMD	SHARP	PC817

## EVb TEST RESULTS

$V_{DD} - V_{SS} = 48V$ ,  $V_{OUT} = 12V$ ,  $I_{OUT} = 2.1A$ ,  $T_A = 25^\circ C$ , unless otherwise noted.

Efficiency

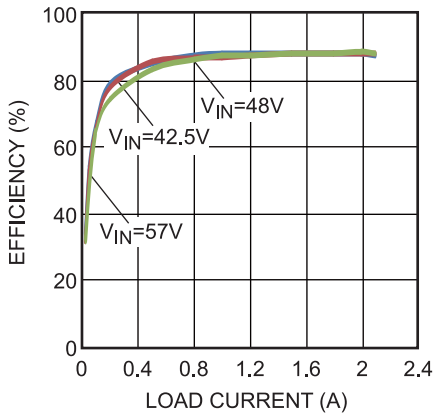

Load Regulation

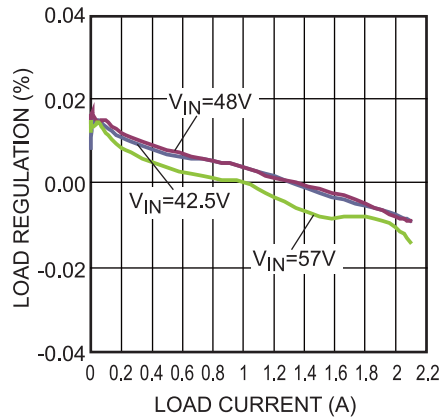

Line Regulation

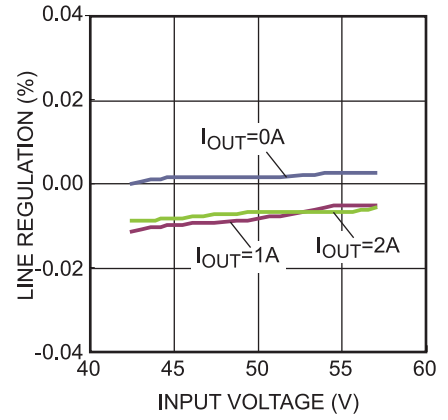

### Bode Plot vs. Frequency

$I_{OUT} = 2.1A$

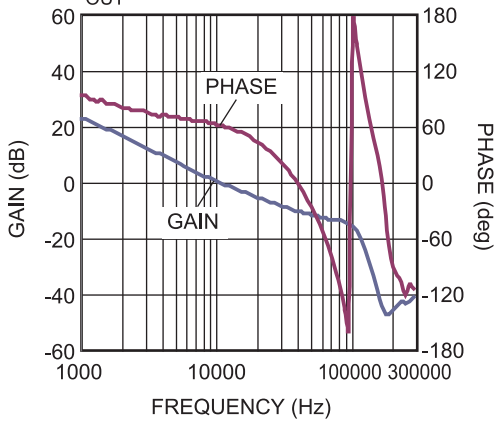

**EVB TEST RESULTS (continued)**

$V_{DD} - V_{SS} = 48V$ ,  $V_{OUT} = 12V$ ,  $I_{OUT} = 2.1A$ ,  $T_A = 25^\circ C$ , unless otherwise noted.

**Steady State**

$I_{OUT} = 0A$

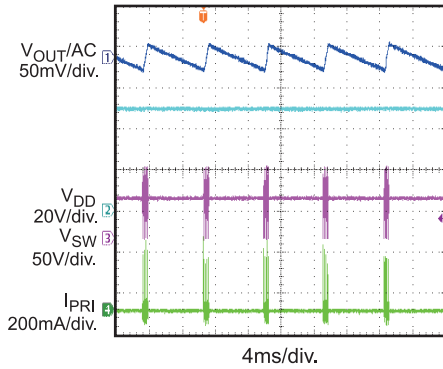

**Steady State**

$I_{OUT} = 2.1A$

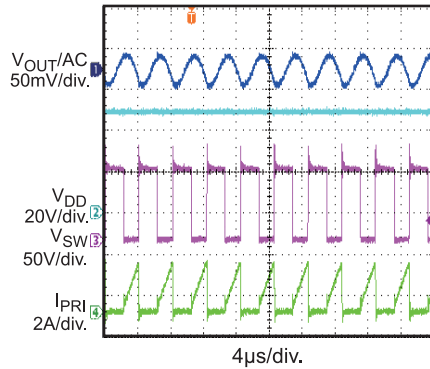

**V<sub>DD</sub> Start-Up**

$I_{OUT} = 0A$

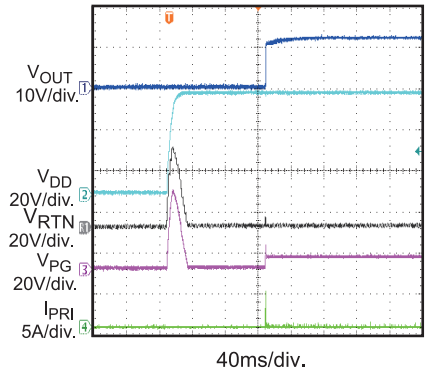

**V<sub>DD</sub> Start-Up**

$I_{OUT} = 2.1A$

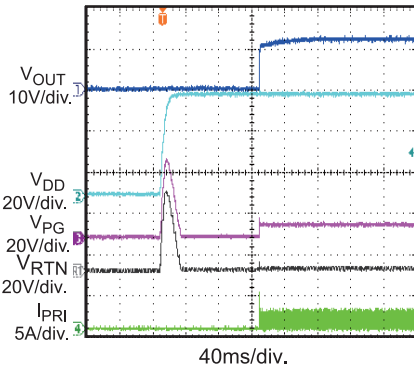

**V<sub>DD</sub> Shutdown**

$I_{OUT} = 0A$

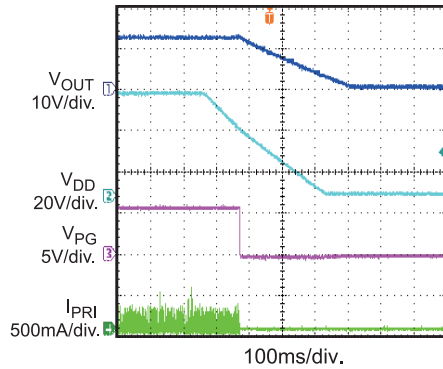

**V<sub>DD</sub> Shutdown**

$I_{OUT} = 2.1A$

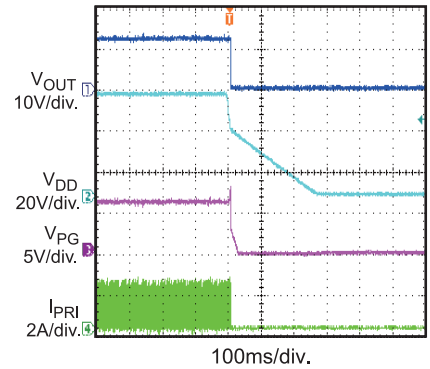

**SCP Entry**

$I_{OUT} = 0A$  to Short

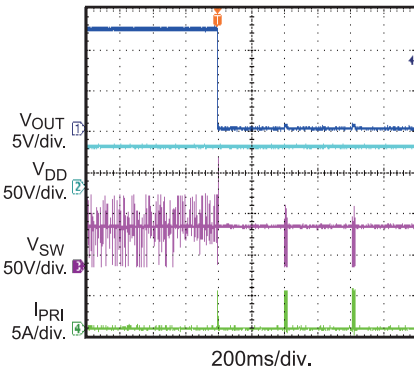

**SCP Entry**

$I_{OUT} = 2.1A$  to Short

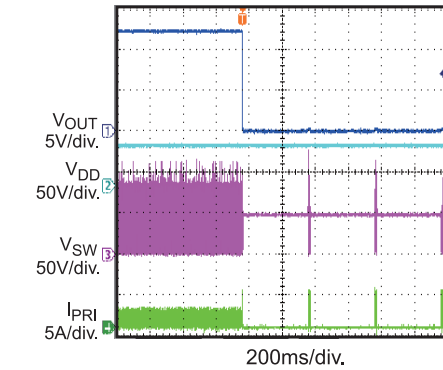

**SCP Recovery**

$I_{OUT} =$  Short to 0A

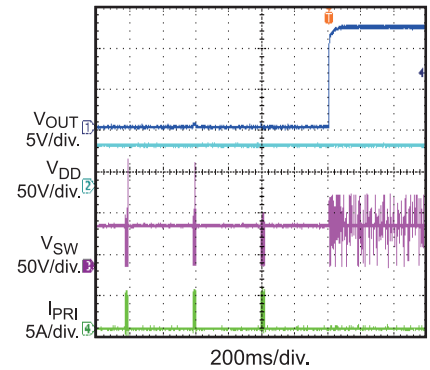

## EVB TEST RESULTS (continued)

$V_{DD} - V_{SS} = 48V$ ,  $V_{OUT} = 12V$ ,  $I_{OUT} = 2.1A$ ,  $T_A = 25^\circ C$ , unless otherwise noted.

### SCP Recovery

$I_{OUT} = \text{Short to } 2.1A$

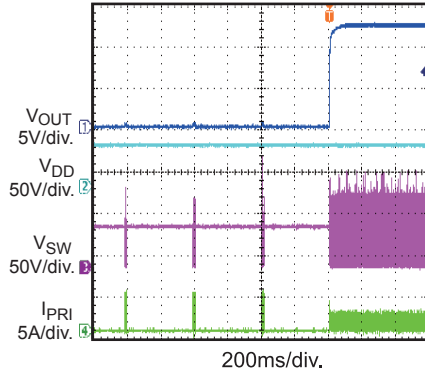

### Load Transient

$I_{OUT} = 0A \text{ to } 1A$ ,  $I_{ramp} = 25mA/\mu s$

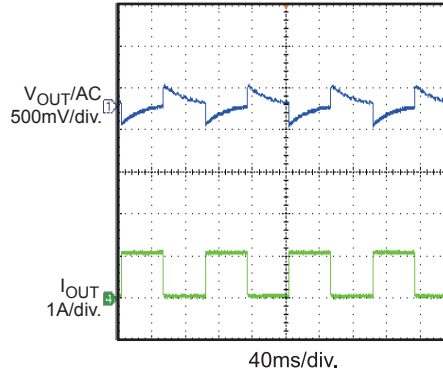

### Load Transient

$I_{OUT} = 1A \text{ to } 2.1A$ ,  $I_{ramp} = 25mA/\mu s$

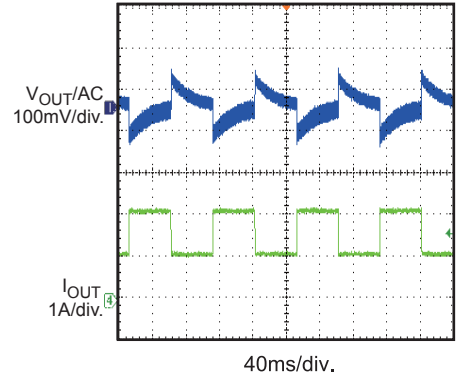

## PRINTED CIRCUIT BOARD LAYOUT

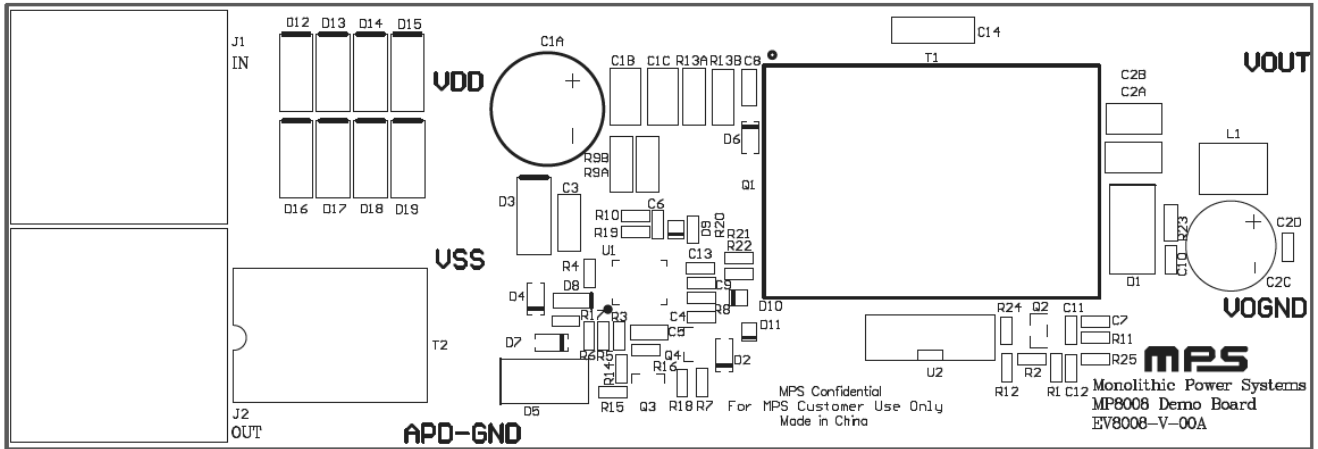

**Figure 1: Top Silk Layer**

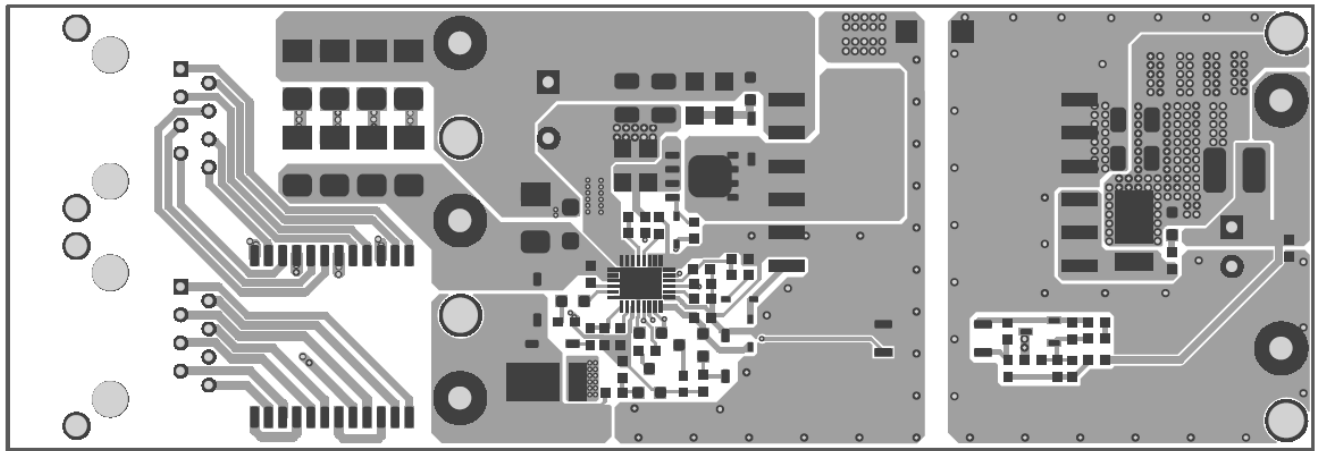

**Figure 2: Top Layer**

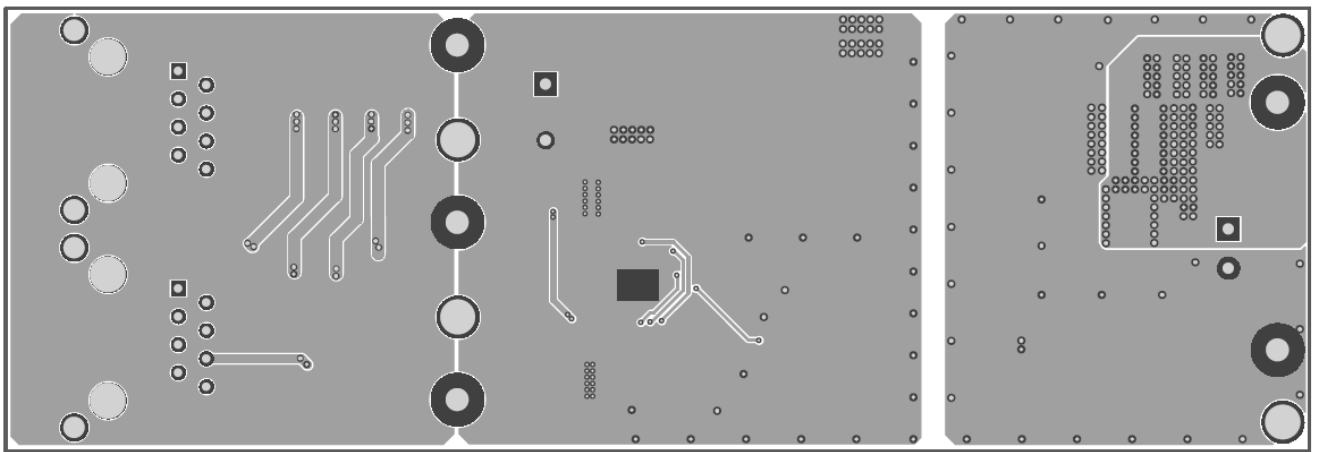

**Figure 3: Bottom Layer**



## QUICK START GUIDE

The output voltage of this board is set to 12V. The board layout accommodates most commonly used components. There are two methods to start EV8008-V-00A.

Method 1:

1. Connect Load to:
  - a. Positive (+): VOUT
  - b. Negative (–): VOGND
2. Plug the cable coming from the PSE into the Ethernet Jack J1. The board will automatically startup.

Method 2:

1. Preset Power Supply to  $40V \leq V_{IN} \leq 57V$ . (It can work in  $37V \leq V_{IN} \leq 57V$  after power up.)
2. Turn Power Supply off.
3. Connect Power Supply terminals to:
  - a. Positive (+): VDD
  - b. Negative (–): VSS
4. Connect Load to:
  - a. Positive (+): VOUT
  - b. Negative (–): VOGND
5. Turn Power Supply on after making connections.
6. The MP8008 is enabled on the evaluation board once VIN is applied.
7. To use adapter supply function, connect the 12V adapter's positive terminal to VDD and negative terminal to APD-GND, then turn on the adapter, the board will prior use adapter to supply itself. When use this adapter function and load current is heavy, some components' temperature should be high, it is limited by board size.

**NOTICE:** The information in this document is subject to change without notice. Please contact MPS for current specifications. Users should warrant and guarantee that third party Intellectual Property rights are not infringed upon when integrating MPS products into any application. MPS will not assume any legal responsibility for any said applications.