



EV5030D-QH-00A

USB Charging Port Controller with Current Limit Switch, Supporting CDP, DCP Modes

DESCRIPTION

The EV5030D-QH-00A is an evaluation board for MP5030D, which integrates an USB current limit switch and charging port identification circuit. It achieves 3A continuous output current over a wide input supply range.

With MP5030D, it supports Dedicated Charging Port (DCP) and Charging Downstream Port (CDP) schemes for Battery Charging specification (BC1.2), the divider Mode, 1.2V/1.2V Mode without the need for external user interaction.

MP5030D provides linear line drop compensation, load current detection and status indication.

Fault condition protection includes hiccup current limiting, input OVP and thermal shutdown.

MP5030D requires a minimum number of readily standard external components to complete USB switch and charging mode auto detection solution. MP5030D is available in QFN-10(1.5mmx2mm) package.

ELECTRICAL SPECIFICATION

Parameter	Symbol	Value	Units
System Input Voltage	V_{IN}	12	V
Default Output Voltage	V_{OUT}	5	V
Output Current	I_{OUT}	3	A

FEATURES

- Load Current Detection and Status Indication
- Up to 14V Operating Input Voltage Range
- Support DCP schemes for BC 1.2, Divider Mode and 1.2V/1.2V Mode
- Support CDP Mode for USB 2.0 Data
- Line Drop Compensation
- Programmable High Accuracy Current Limit
- 32m Ω Low- $R_{DS(ON)}$ Power MOSFET
- Input over Voltage Shutdown Protection
- Thermal Shutdown

APPLICATIONS

- USB Charging Downstream Port (CDP)
- USB Dedicated Charging Ports (DCP)

All MPS parts are lead-free, halogen-free, and adhere to the RoHS directive. For MPS green status, please visit the MPS website under Quality Assurance. "MPS" and "The Future of Analog IC Technology" are registered trademarks of Monolithic Power Systems, Inc.

EV5030D-QH-00AEVALUATION BOARD

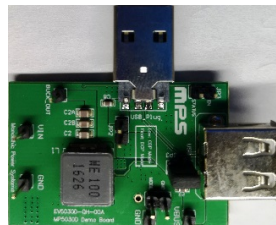

(L×W)4.38cm× 2.89cm

Board Number	MPS IC Number
EV5030D-QH-00A	MP5030DGQH

EVALUATION BOARD SCHEMATIC

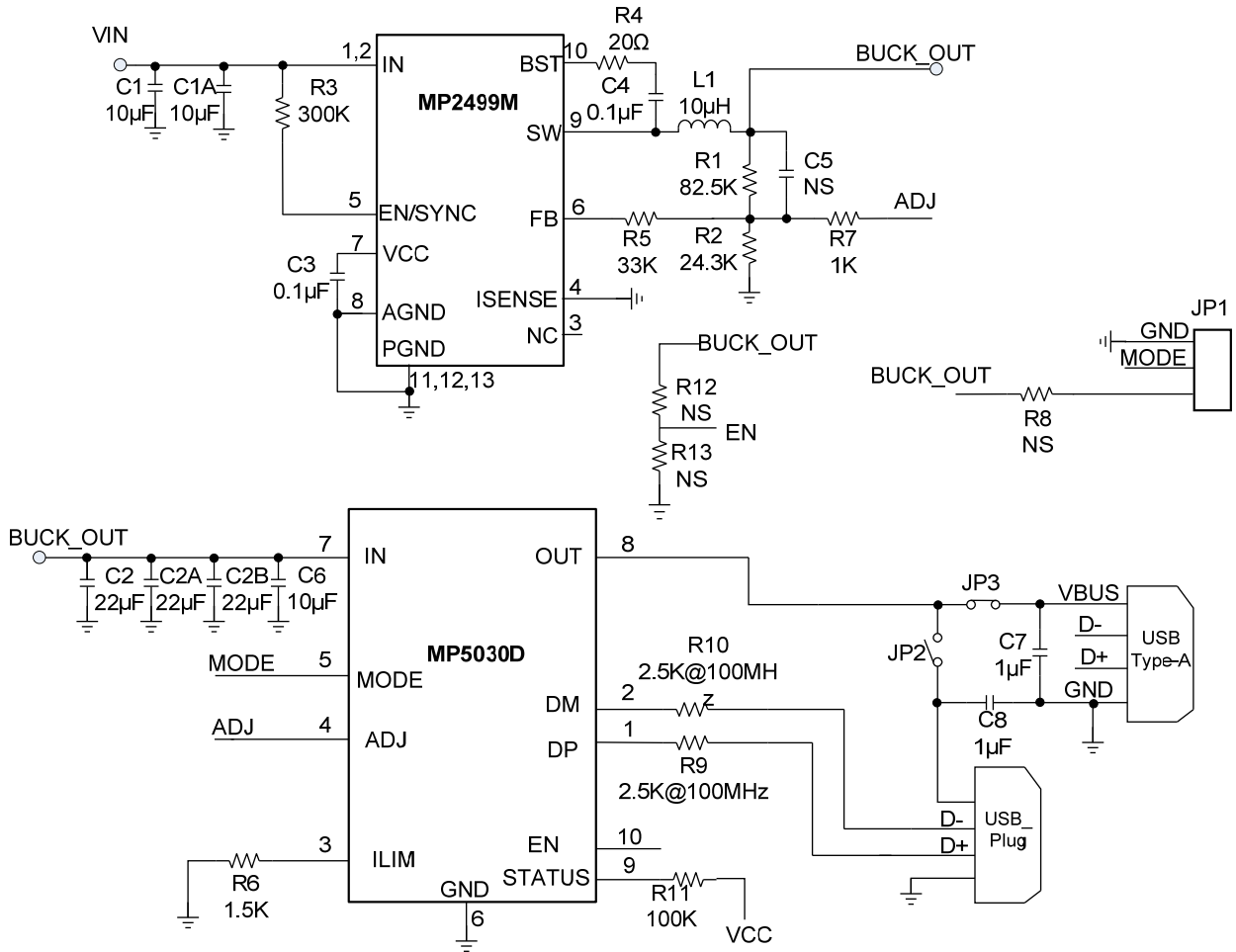

NOTE: In the default settings, MODE pin short to GND for CDP mode.

EV5030D-QH-00A BILL OF MATERIALS

Qty	Ref	Value	Description	Package	Manufacturer	Part Number
2	C1, C1A	10 μ F	Ceramic Capacitor, 35V, X5R	0805	Murata	GRM21BR61E106KA43L
3	C2, C2A, C2B	22 μ F	Ceramic Capacitor, 25V, X5R	0805	Murata	GRM21BR61E226ME44L
2	C3, C4	0.1 μ F	Ceramic Capacitor, 25V, X7R	0603	Murata	GRM188R71E104KA01D
0	C5, R8, R12, R13	NS				
1	C6	10 μ F	Ceramic Capacitor, 25V, X5R	0603	Murata	GRM21BR61E106MA73L
2	C7, C8	1 μ F	Ceramic Capacitor, 25V, X5R	0603	Murata	885012206076
1	R1	82.5k Ω	Film Resistor, 1%	0603	YAGEO	RC0603FR-0782K5L
1	R2	24.3k Ω	Film Resistor, 1%	0603	YAGEO	RC0603FR-0724K3L
1	R3	300k Ω	Film Resistor, 1%	0603	YAGEO	RC0603FR-07300KL
1	R4	20 Ω	Film Resistor, 1%	0603	YAGEO	RC0603FR-0720RL
1	R5	33k Ω	Film Resistor, 1%	0603	YAGEO	RC0603FR-0733KL
1	R6	1.5k Ω	Film Resistor, 1%	0603	YAGEO	RC0603FR-071K5L
1	R7	1k Ω	Film Resistor, 1%	0603	YAGEO	RC0603FR-071KL
2	R11	100k	Film Resistor, 1%	0603	YAGEO	RC0603FR-07100KL
2	R9,R10	2.5k Ω	Magnetic bead, 2.5k Ω @100MHz	0603	Würth	742792695
1	L1	10 μ H	Inductor, 12.5A Isat, DCR 30m Ω	SMD	Würth	74437368100
1	USB	TYPE-A	TYPE-A USB Port	DIP	Würth	61400416021
1	USB_Plug	USB	Single USB Plug	SMD	Würth	629004113921
1	U1	MP2499M	Synchronous Step-Down Converter	QFN-13 (2.5mm \times 3mm)	MPS	MP2499M
1	U2	MP5030D	Controller with USB Current Limit SW, supporting CDP, DCP.	QFN-10 (1.5mm \times 2mm)	MPS	MP5030DGQH

TYPICAL PERFORMANCE CHARACTERISTICS (continued)

$V_{IN} = 5V$, $V_{OUT} = 5V$, $R_{ILIM} = 1.5k\Omega$, $T_A = 25^\circ C$, unless otherwise noted. Connect MP5030D Input to MP2499M Output, System_VIN=12V is MP2499M Input Voltage.

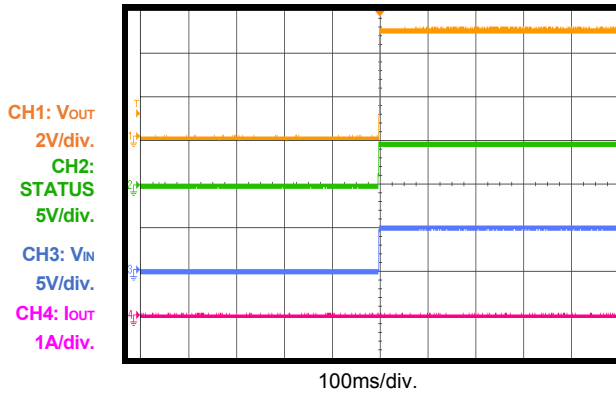
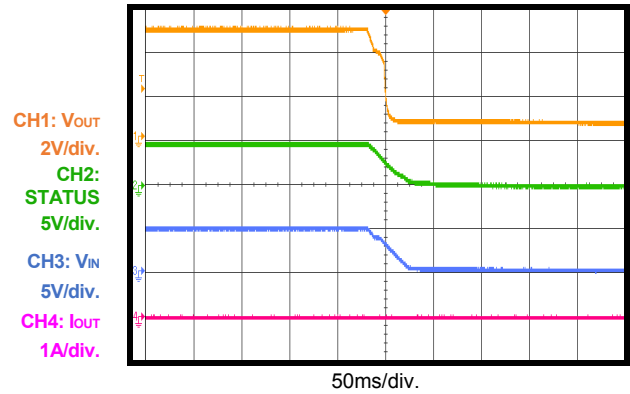
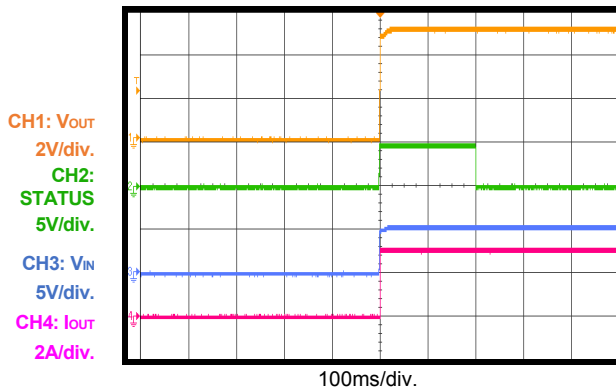
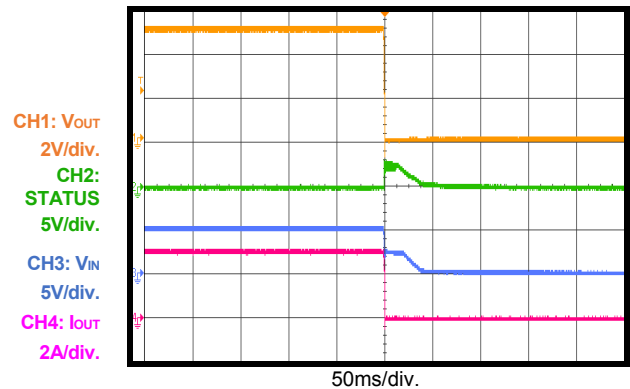
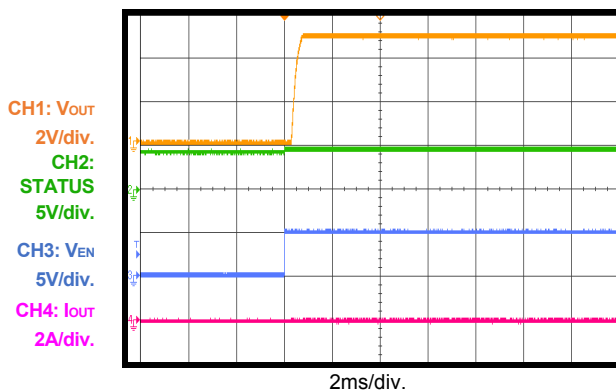
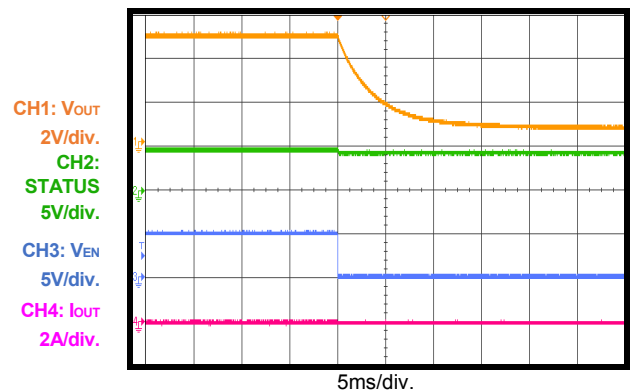
Start-Up through Input Voltage
 $I_{OUT}=0A$

Shutdown through Input Voltage
 $I_{OUT}=0A$

Start-Up through Input Voltage
 $I_{OUT}=3A$

Shutdown through Input Voltage
 $I_{OUT}=3A$

EN start-up
 $I_{OUT}=0A$

EN shutdown
 $I_{OUT}=0A$

TYPICAL PERFORMANCE CHARACTERISTICS (continued)

$V_{IN} = 5V$, $V_{OUT} = 5V$, $R_{ILIM} = 1.5k\Omega$, $T_A = 25^\circ C$, unless otherwise noted. Connect MP5030D Input to MP2499M Output, System_VIN=12V is MP2499M Input Voltage.

EN start-up

$I_{OUT}=3A$

CH1: V_{OUT}
2V/div.
CH2: STATUS
5V/div.
CH3: V_{EN}
5V/div.
CH4: I_{OUT}
2A/div.

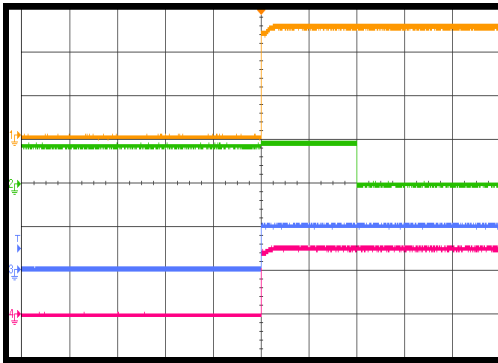

100ms/div.

EN shutdown

$I_{OUT}=3A$

CH1: V_{OUT}
2V/div.
CH2: STATUS
5V/div.
CH3: V_{EN}
5V/div.
CH4: I_{OUT}
2A/div.

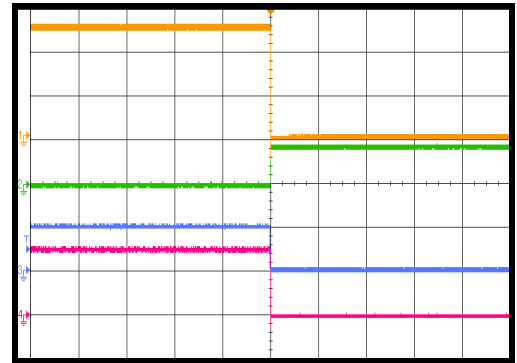

100ms/div.

Mode Pin changes from Float to GND

D+ and D- float, $I_{OUT}=3A$

CH1: V_{OUT}
5V/div.
CH2: V_{D+}
2V/div.
CH3: V_{D-}
2V/div.
CH4: I_{OUT}
5A/div.

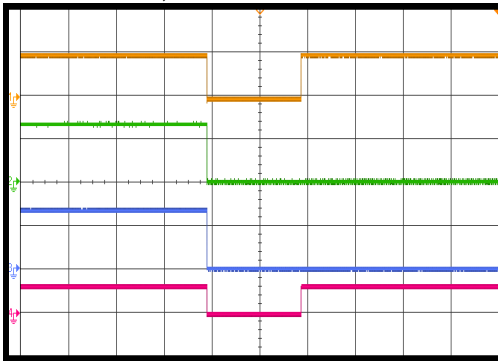

500ms/div.

Mode Pin changes from Float to GND

D+ and D- float, $I_{OUT}=3A$

CH1: V_{OUT}
5V/div.
CH2: V_{IN}
5V/div.
CH3: STATUS
5V/div.
CH4: I_{OUT}
5A/div.

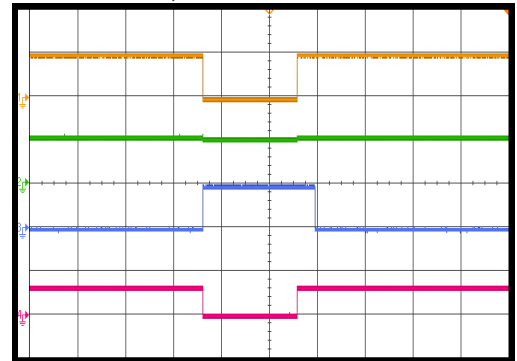

500ms/div.

Mode Pin changes from GND to Float

D+ and D- float, $I_{OUT}=3A$

CH1: V_{OUT}
5V/div.
CH2: V_{D+}
2V/div.
CH3: V_{D-}
2V/div.
CH4: I_{OUT}
5A/div.

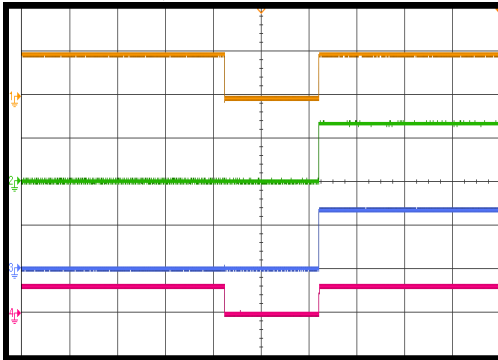

500ms/div.

Mode Pin changes from GND to Float

D+ and D- float, $I_{OUT}=3A$

CH1: V_{OUT}
5V/div.
CH2: V_{IN}
5V/div.
CH3: STATUS
5V/div.
CH4: I_{OUT}
5A/div.

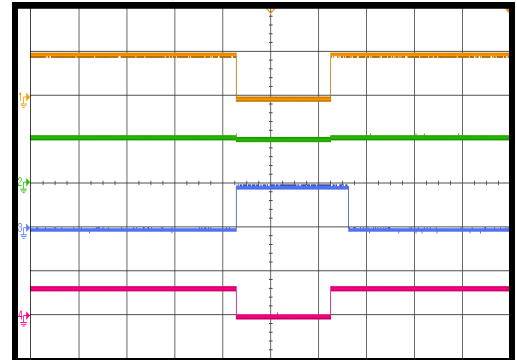

500ms/div.

TYPICAL PERFORMANCE CHARACTERISTICS (continued)

$V_{IN} = 5V$, $V_{OUT} = 5V$, $R_{ILIM} = 1.5k\Omega$, $T_A = 25^\circ C$, unless otherwise noted. Connect MP5030D Input to MP2499M Output, System_VIN=12V is MP2499M Input Voltage.

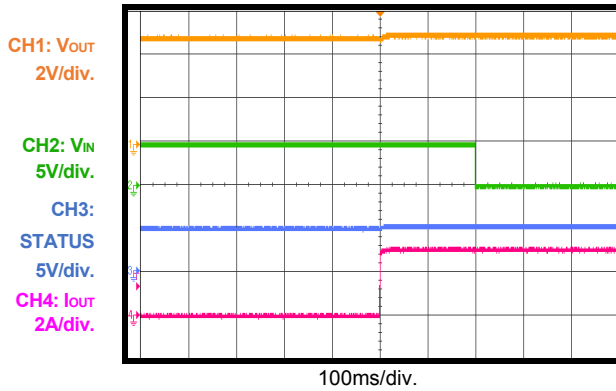
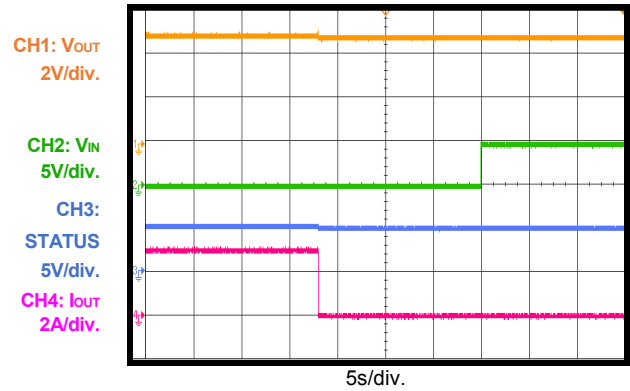
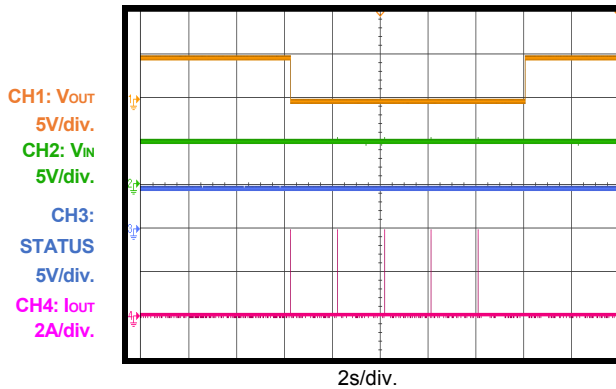
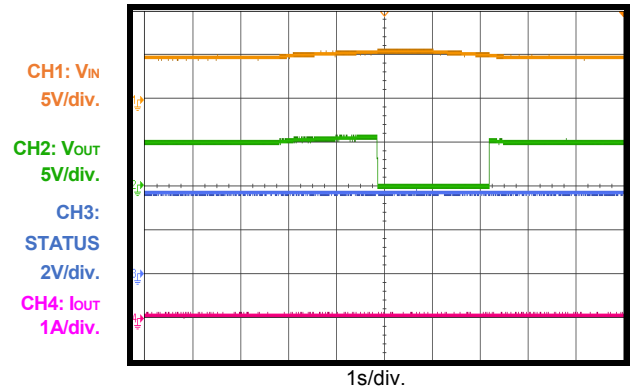
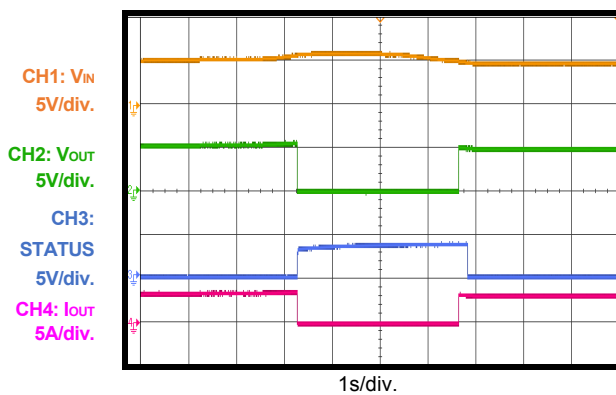
Status function
 $I_{OUT}=0A$ to 3A

Status function
 $I_{OUT}=3A$ to 0A

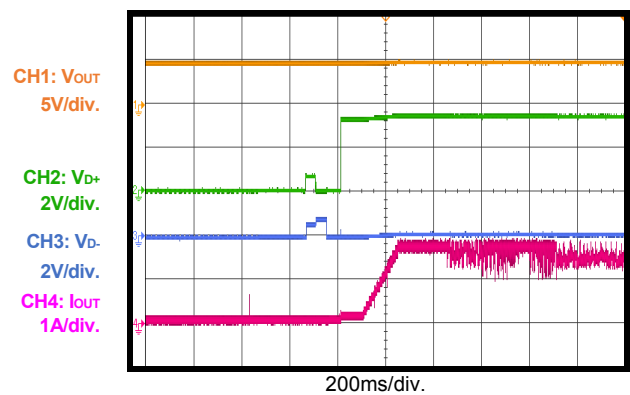
Short-Circuit Protection Entry and Recovery

Input Over-Voltage Protection
 $I_{OUT}=0A$

Input Over-Voltage Protection
 $I_{OUT}=3A$

CDP Mode Detection

Mobile Phone Plug In



TYPICAL PERFORMANCE CHARACTERISTICS *(continued)*

$V_{IN} = 5V$, $V_{OUT} = 5V$, $R_{LIM} = 1.5k\Omega$, $T_A = 25^\circ C$, unless otherwise noted. Connect MP5030D Input to MP2499M Output, System_VIN=12V is MP2499M Input Voltage.

Eye Pattern Test

Recommended CDP Mode Setup

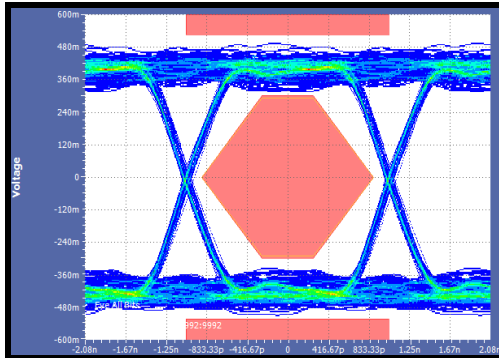

PRINTED CIRCUIT BOARD LAYOUT

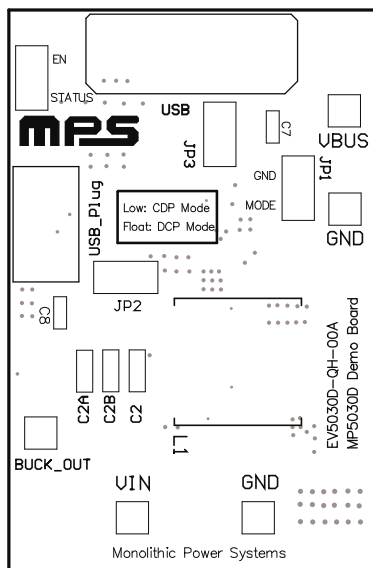

Figure 1: Top Silk Layer

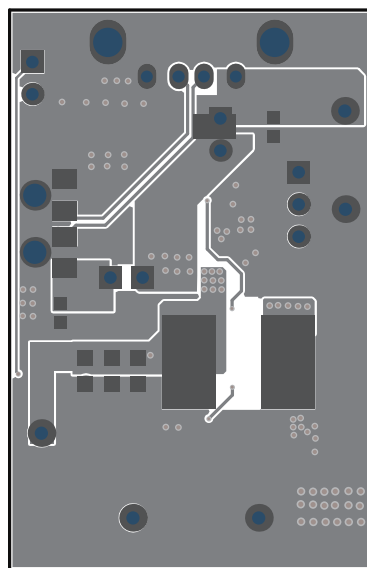

Figure 2: Top Layer

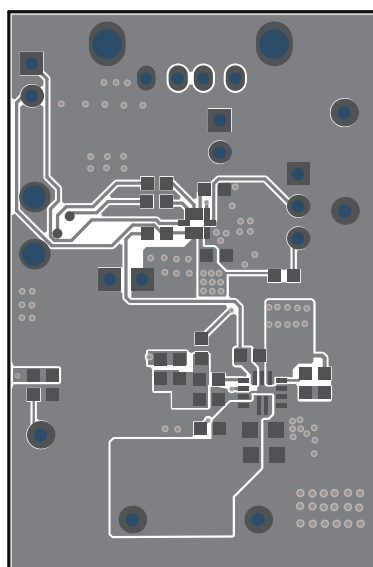

Figure 3: Bottom Layer

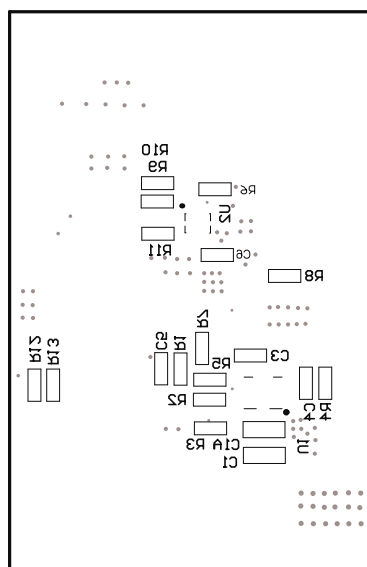

Figure 4: Bottom Silk Layer

QUICK START GUIDE

1. Preset Power Supply to 12V.
2. Turn Power Supply off.
3. Connect Power Supply terminals to:
 - a. Positive (+): VIN
 - b. Negative (-): GND
4. EN pin for MP5030D: pull high or float enables the IC; pull low to disable the IC. EN is float in the demo board. STATUS pin for MP5030D is open drain output.
5. For default CDP mode, JP2 should open, MODE pin short to GND by JP1, USB_plug connect to USB host. Turn power supply on after making connections, the board will automatically start up. Connect different mobile phones to Type-A USB port for CDP mode test.
6. For DCP mode, JP2 should open, MODE pin should be float, R9 and R10 should be replaced by 0Ω resistor. Do not use USB_Plug port.

NOTICE: The information in this document is subject to change without notice. Please contact MPS for current specifications. Users should warrant and guarantee that third party Intellectual Property rights are not infringed upon when integrating MPS products into any application. MPS will not assume any legal responsibility for any said applications.