

DESCRIPTION

The MP5016H is a protection device designed to protect circuitry on the output from transients on input. It also protects input from undesired shorts and transients coming from the output.

At startup, inrush current is limited by limiting the slew rate at the output. The slew rate is controlled by DV/DT pin setting and MODE pin setting.

The maximum load at the output is current limited. The magnitude of the current limit is controlled by an external resistor from ILIMIT to GND. There is a fixed 2.5A current limit when floating ILIMIT pin.

The output voltage is limited by output OVP function, the clamp voltage can be set by MODE pin connection.

Offers a GATE drive signal to block current flows from output to input with an external N-channel MOSFETs.

The MP5016H is available in a QFN10 (1.5mm x 2mm) package.

ELECTRICAL SPECIFICATION

| Parameter | Value | Units |
|-----------------|-----------|-------|
| Input Voltage | 2.7 to 22 | V |
| Current Limit | 2.5 | A |
| DV/DT Slew Rate | 3.8 | V/ms |

FEATURES

- Wide 2.7V to 22V Continued Operating Input Range
- 26V Absolute Maximum Transient Input Voltage
- Selectable Over Voltage Clamp Threshold
- Fast Output OVP Response
- Integrated 43mΩ Power FET
- Adjustable Current-Limit or Fixed Current Limit when floating ILIMIT pin
- Reverse Current Blocking CTRL
- Soft Start Time Programmable through DV/DT pin and MODE pin
- Fast Response for Hard Short Protection
- OCP Hiccup Protection
- Thermal Shutdown and Auto Retry
- Available in QFN10 (1.5mmx2mm) Package

APPLICATIONS

- HDD, SSD
- Hot Swap
- Wireless Modem Data Cards
- PC Cards
- USB Power Distribution
- USB Protection
- USB3.1 Power Delivery

All MPS parts are lead-free, halogen free, and adhere to the RoHS directive. For MPS green status, please visit MPS website under Quality Assurance. "MPS" and "The Future of Analog IC Technology" are Registered Trademarks of Monolithic Power Systems, Inc.

EV5016H-QH-00B EVALUATION BOARD



(L×W)5.0cm×5.0cm

| Board Number | MPS IC Number |
|----------------|---------------|
| EV5016H-QH-00B | MP5016HGQH |

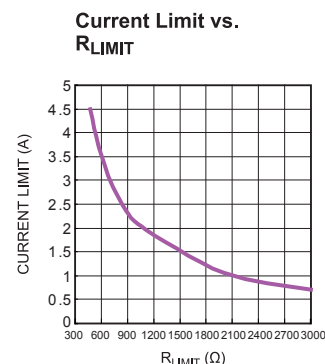

EVALUATION BOARD SCHEMATIC

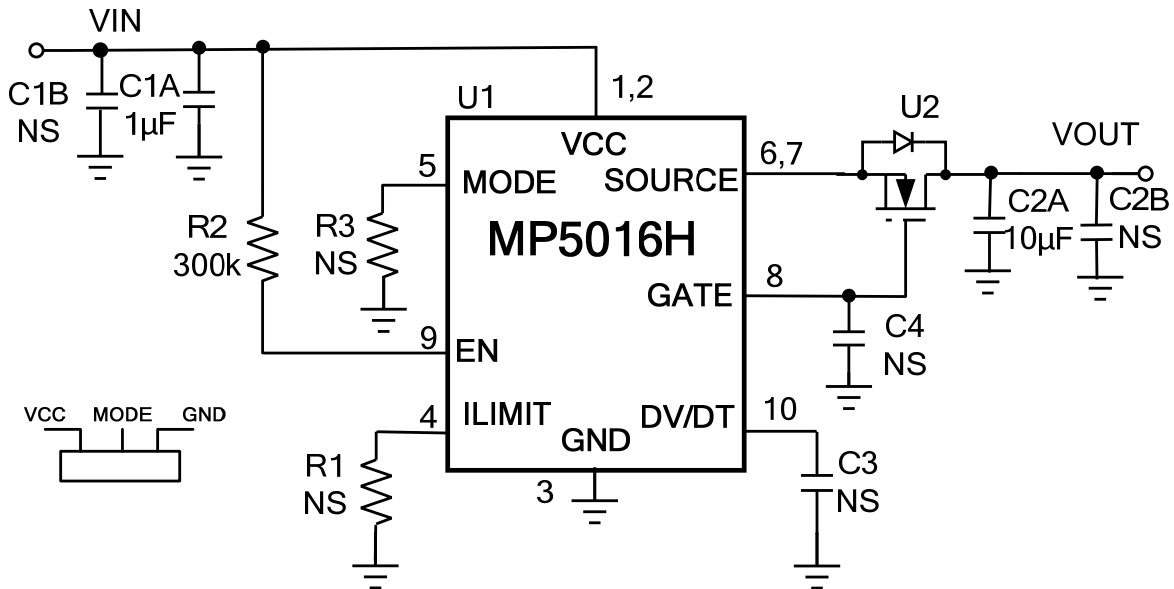

EV5016H-QH-00B BILL OF MATERIALS

| Qty | Ref | Value | Description | Package | Manufacturer | Manufacturer P/N |
|-----|--------------------|-----------|---|-----------------|--------------|--------------------|
| 1 | C1A | 1µF | Ceramic Cap,25V,X5R | 0805 | Murata | GRM216R61E105KA12D |
| 0 | C1B, C2B, C3,C4 | NS | | | | |
| 1 | C2A | 10µF | Ceramic Cap,25V,X5R | 0805 | Murata | GRM21BR61E106KA73L |
| 0 | R1, R3 | NS | | | | |
| 1 | R2 | 300k | 1% resistor | 0603 | ROYAL | RL0603FR-07300KL |
| 1 | U1 | MP5016H | Electronic Fuse | QFN 1.5x2-10 | MPS | MP5016HGQH |
| 1 | U2 | IRFHS8342 | NMOS, Vds=30V, Vgs=20V. Rds(on)=16mΩ, | QFN 2x2 | Infineon | IRFHS8342 |

EVB TEST RESULTS

$V_{IN}=5V$, $V_{OUT}=5V$, I_{LIMIT} pin float, $MODE$ pin float, DV/DT pin float, $C_{OUT}=10\mu F$, $T_A=25^\circ C$, unless otherwise noted.

Start-Up through Input Voltage

$I_{LOAD}=0A$

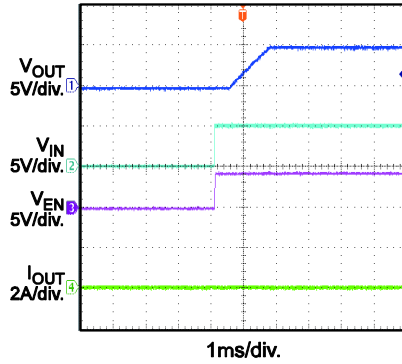

Start-Up through Input Voltage

$I_{LOAD}=2A$

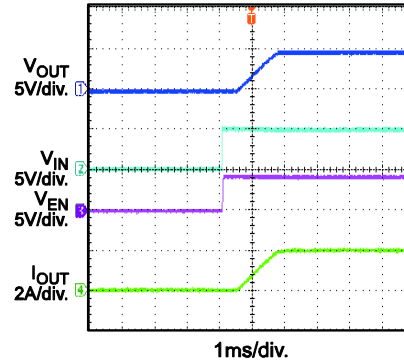

Start-Up through Input Voltage

$I_{LOAD}=0A$, $C_{OUT}=1000\mu F$

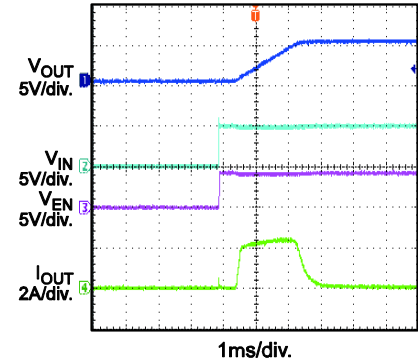

Start-Up through Enable

$I_{LOAD}=0A$

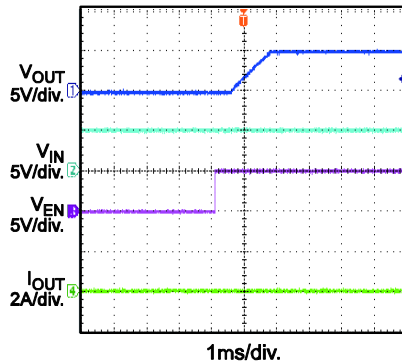

Start-Up through Enable

$I_{LOAD}=2A$

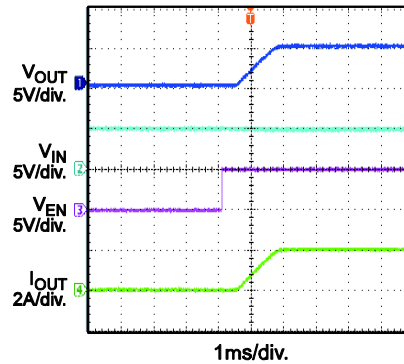

Start-Up through Enable

$I_{LOAD}=0A$, $C_{OUT}=1000\mu F$

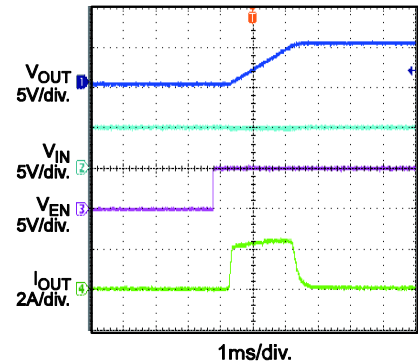

Shutdown through Input Voltage

$I_{LOAD}=0A$

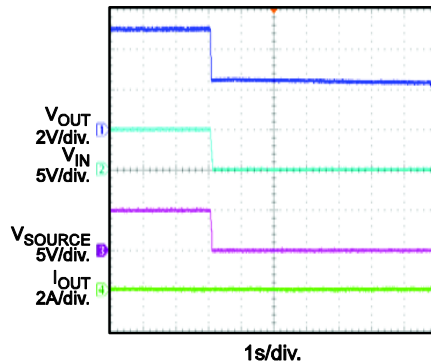

Shutdown through Input Voltage

$I_{LOAD}=2A$

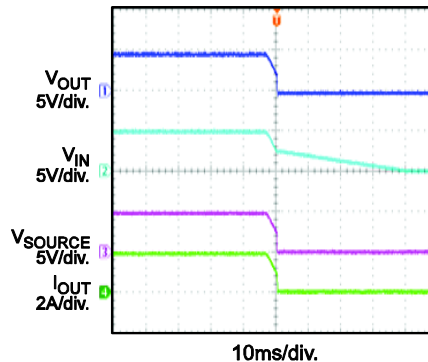

Shutdown through Enable

$I_{LOAD}=0A$

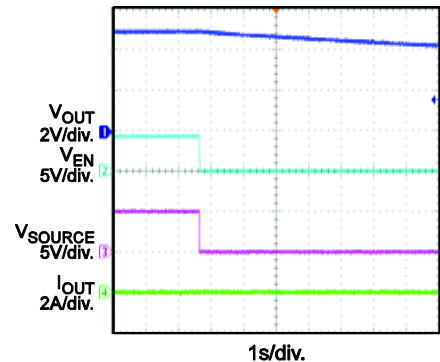

EVB TEST RESULTS

$V_{IN}=5V$, $V_{OUT}=5V$, I_{LIMIT} pin float, $MODE$ pin float, DV/DT pin float, $C_{OUT}=10\mu F$, $T_A=25^\circ C$, unless otherwise noted.

Shutdown through Enable
 $I_{LOAD}=2A$

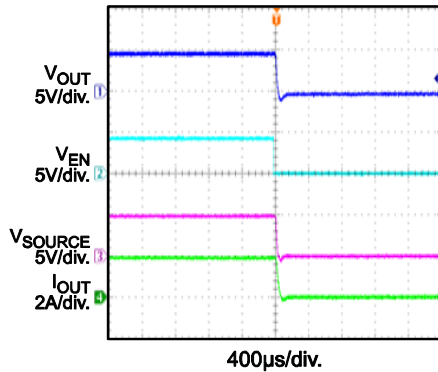

Current Limit
 Increase I_{OUT} Slowly

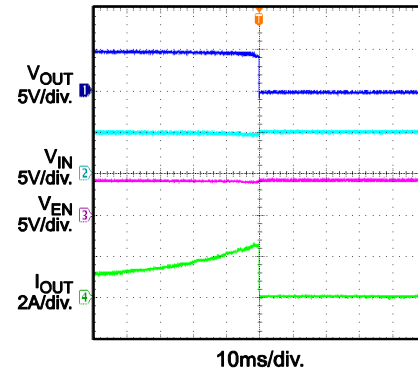

Short Circuit during Normal Operation and Hiccup
 $I_{LOAD}=0A$

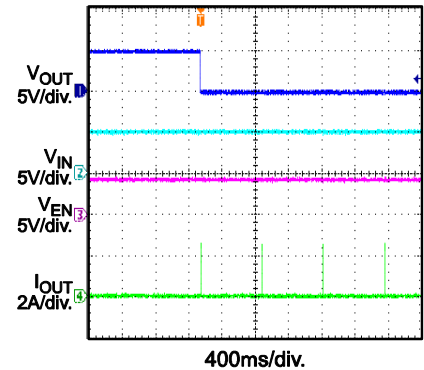

Reverse Current Protection during EN Shutdown

$V_{OUT} = 5V$, Pull EN Low

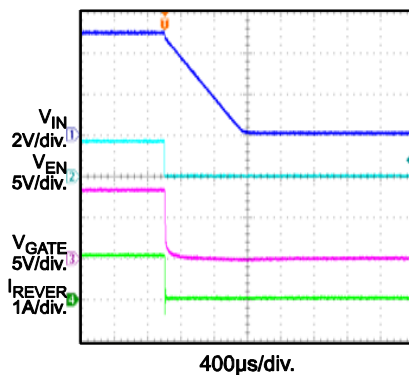

CIRCUIT BOARD LAYOUT

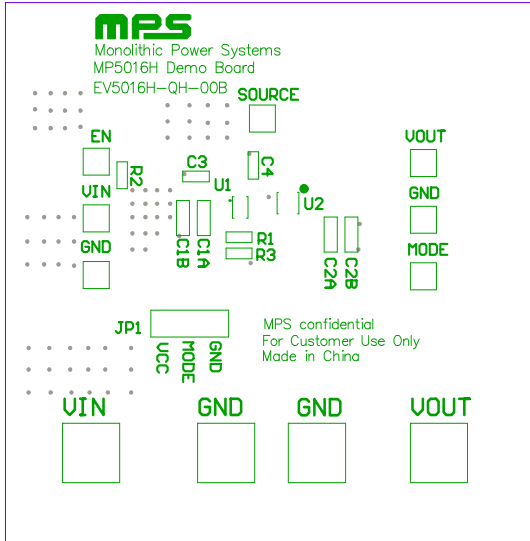

Figure 1: Top Silkscreen Layer

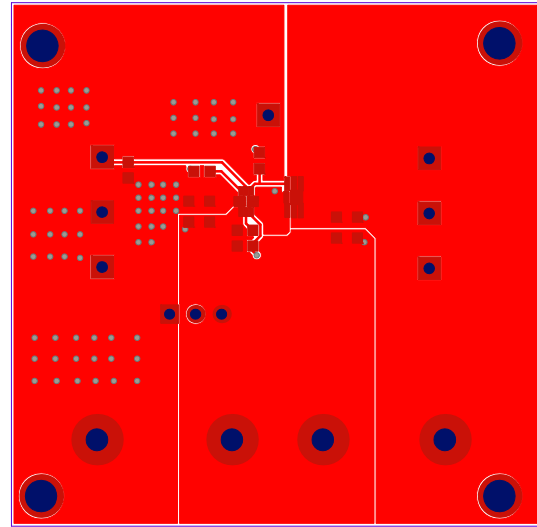

Figure 2: Top Layer

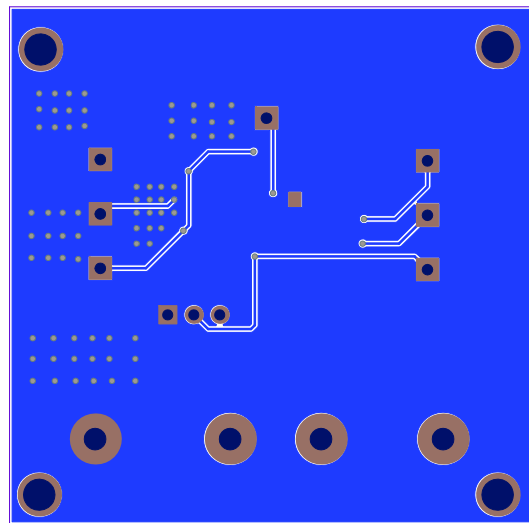

Figure 3: Bottom Layer

QUICK START GUIDE

1. Preset Power Supply to 2.7V-22V.
2. Turn Power Supply off.
3. Connect Power Supply terminals to:
 - a. Positive (+): VIN
 - b. Negative (–): GND
4. Connect Load to:
 - a. Positive (+): VOUT
 - b. Negative (–): GND
5. Turn Power Supply on after making connections. The board will automatically start up.
6. To use the Enable function, apply a digital input to the EN pin. Drive EN higher than 2.0V to turn on the regulator, or less than 1.6V to turn it off.
7. The default current limit is 2.5A (typical). To set different current limit, please choose proper R1. See details in MP5016H datasheet.
8. Set MODE pin (High/Low/Float by JP1 or setup R3) before power up to get proper OVP threshold.
9. To set different soft start time, change the C3 value and MODE pin setting.
10. Setting an appropriate OVP threshold can also protect the reverse voltage (from the output to the input) on EV5016H-QH-00B. See details in MP5016H datasheet.

NOTICE: The information in this document is subject to change without notice. Please contact MPS for current specifications. Users should warrant and guarantee that third party Intellectual Property rights are not infringed upon when integrating MPS products into any application. MPS will not assume any legal responsibility for any said applications.