



# EV4245-VE-00A

## 36V, 6A Peak, Buck-Boost Converter with I2C Interface for Power Delivery

### DESCRIPTION

The EV4245-VE-00A is an evaluation board for MP4245, a Buck-Boost converter with 4 integrated power switches. The device can deliver up to 6A output current at certain input-supply range with excellent load and line regulation.

The MP4245 is suitable for USB power delivery (USB PD) application. It can work well with external USB PD controller through I2C interface.

The I2C interface and MTP (2 times programmable) provide flexibility of programmable features.

Fault condition protection includes CC current limiting, output OVP, and thermal shutdown (TSD).

The MP4245 requires a minimum number of readily available, standard, external components. The MP4245 is available in a QFN21 (4mmx5mm) package.

### ELECTRICAL SPECIFICATION

Parameter	Symbol	Value	Units
Input Voltage	VIN	4 - 36	V
Output Voltage	VOUT	5	V
Output Current <sup>(1)</sup>	IOUT	3	A

#### Notes:

1) Default output current limit is 3.6A.

### FEATURES

- Support 60W Buck-Boost or 6A Peak Iout
- Wide 4V to 36V Operating Input-Voltage Range
- 1V to 21V Output-Voltage Range
- 250kHz, 350kHz and 420kHz Frequency Selectable or SYNC Input
- 11mΩ/22mΩ/12mΩ/12mΩ Low R<sub>DS\_ON</sub> for Switch A/B/C/D
- Frequency Spread Spectrum Selectable
- Line Drop Compensation
- Accurate CC Output-Current Limit
- I2C Interface and 2 times programmable MTP (PMBus compatible):
  - PFM/PWM Mode, Current Limit, Output Voltage, Frequency Spread Spectrum, Line Drop Comp, etc.
  - CRC Check for MTP Integrity
- Load Shedding Alert
- EN Shutdown Active Discharge
- Available in a QFN21 (4mmx5mm) Package with Wettable Flanks

### APPLICATIONS

- USB Type-C with PD Charging Only Port
- 12V Bus Voltage Supply
- Wireless Charging

All MPS parts are lead-free, halogen free, and adhere to the RoHS directive. For MPS green status, please visit MPS website under Quality Assurance. "MPS" and "The Future of Analog IC Technology" are Registered Trademarks of Monolithic Power Systems, Inc.

### EVALUATION BOARD



(L x W x H) 5.5cm x 5.5cm x 1.8cm

Board Number	MPS IC Number
EV4245-VE-00A	MP4245GVE-0001

### Efficiency vs. Load Current

V<sub>out</sub>=5V, L=4.7μH, DCR=8mΩ, F<sub>sw</sub>=420kHz

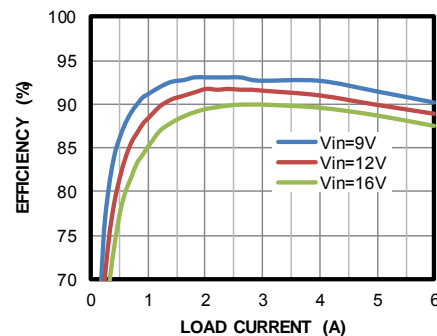

## EVALUATION BOARD SCHEMATIC

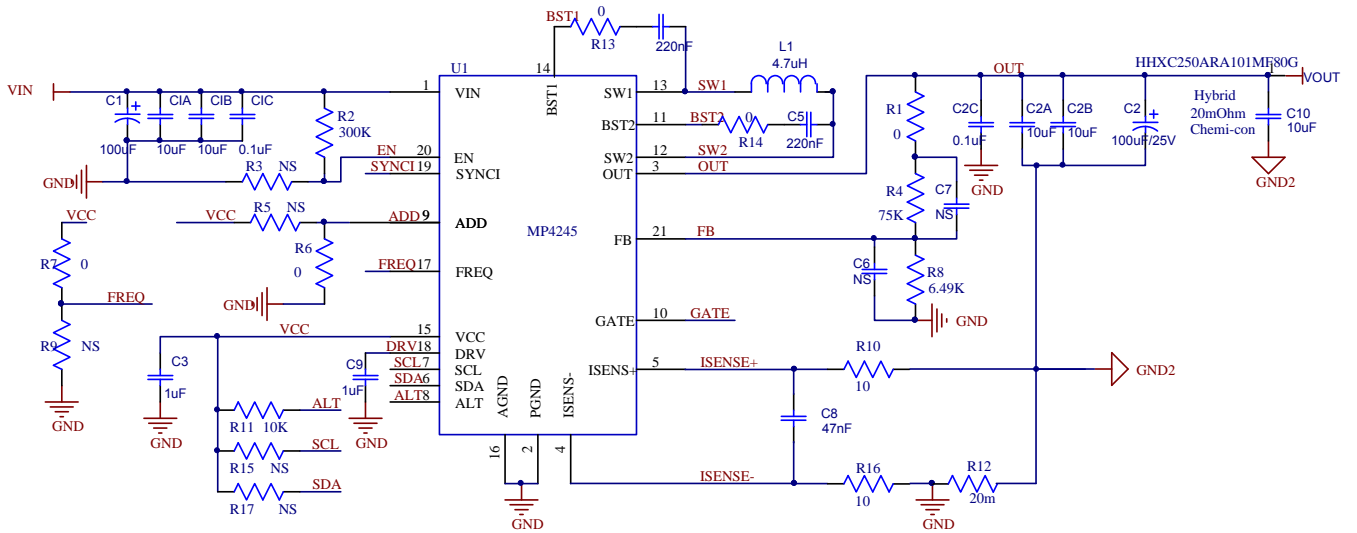

**BILL OF MATERIALS**

Qty	Ref	Value	Description	Package	Manufacturer	Manufacturer PN
1	C1	100µF	100µF/35V	SMD	NIPPON CHEMI-CON	EMZJ350ADA101MF80G
2	CIA,CIB	10µF	Ceramic Cap.,50V,X5R	0805	TDK	C2012X5R1H106K125AC
2	C2A,C2B	10µF	Ceramic Cap.,25V,X5R	0805	TDK	C2012X5R1E106K
1	C2	100µF	25V, Hybrid,20mOhm	SMD	Chemi-con	HHXC250ARA101MF80G
2	C4,C5	220nF	Ceramic Cap.,16V,X7R	0603	WE	885012206048
2	C3,C9	1µF	Ceramic Cap.,16V,X6S	0603	Murata	GRM155C81C105KE11D
0	C6, C7	NS				
1	C10	10µF	Ceramic Cap.,25V,X5R	0805	TDK	C2012X5R1E106K
1	C8	47nF	Ceramic Cap.,25V,X7R	0603	WE	885012206069
2	C2C,C1C	100nF	Ceramic Cap.,50V,X7R	0603	SAMSUNG	CL05B104KB5NNNC
1	R4	75K	Film Res,1%,0603,75K	0603	YAGEO	RC0603FR-0775KL
1	R8	6K49	Film Res,1%,0603,6K49	0603	YAGEO	RC0603FR-076K49L
1	R12	0.02Ω	Film Res,1%,1W,0.02R	1503	Susumu	RL3720WT-R020-F
1	R2	300K	Film Res,1%,0603,300K	0603	YAGEO	RC0603FR-07300KL
1	R11	10K	Film Res,1%,0603,10K	0603	YAGEO	RC0603FR-0710KL
5	R1,R6,R7, R13, R14	0	Film Res,1%,0603,0R	0603	YAGEO	RC0603FR-070RL
2	R10,R16	10Ω	Film Res,1%,0603,10R	0603	YAGEO	RC0603FR-0710RL
1	L1	4.7µH	Inductor,RDC=8 mOhm,Isat=13A	SMD	Superworld	PIAQ1005S4R7MN
0	R9,R3,R5, R15,R17	NS				WBZT52C16-7-F
2	CN1,CN2	3PINS	3Pins,1 row,straight	DIP	WE	61300311121
4	VIN,GND,G ND2,VOUT	φ2.0	φ2.0 copper pin	DIP		φ2.0 copper pin
2	GND, EN	φ1.0	φ1.0 copper pin	DIP		φ1.0 copper pin
1	U1	MP4245 GVE- 0001	BUCK-BOOST CONVERTER	QFN21 (4mm*5mm)	MPS	MP4245GVE-0001

### TYPICAL PERFORMANCE CHARACTERISTICS

Performance waveforms are tested on the evaluation board.

$V_{IN} = 12V$ ,  $V_{OUT} = 5V$ ,  $L = 4.7\mu H$ , Forced PWM mode,  $T_A = 25^\circ C$ , unless otherwise noted.

**CC/CV Curve**  
CC current limit=3.6A

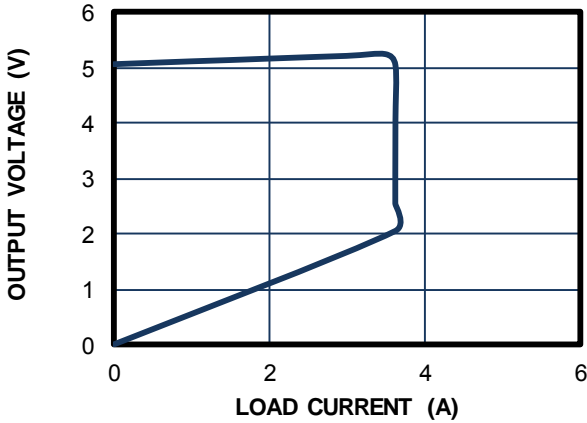

**Bode Plot**

$V_{OUT}=5V$ ,  $I_{OUT}=3A$ ,  $BW=26kHz$ ,  $PM=68deg$

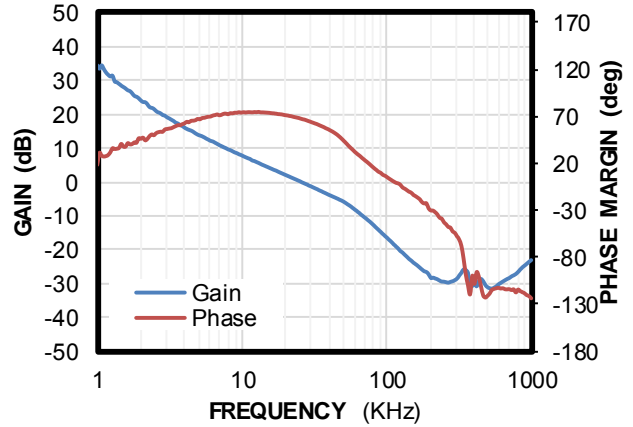

**Bode Plot**

$V_{OUT}=12V$ ,  $I_{OUT}=3A$ ,  $BW=19kHz$ ,  $PM=71deg$

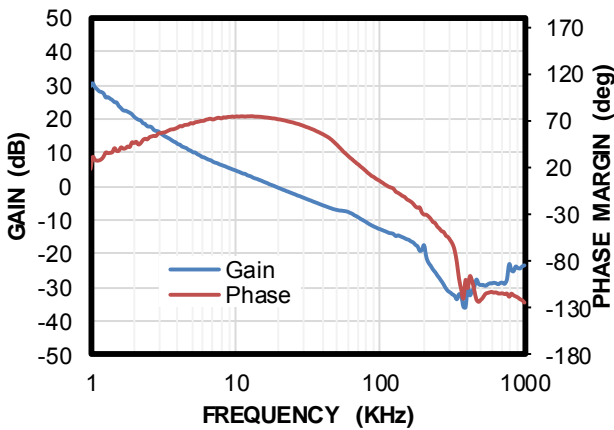

**Bode Plot**

$V_{OUT}=20V$ ,  $I_{OUT}=3A$ ,  $BW=13kHz$ ,  $PM=76deg$

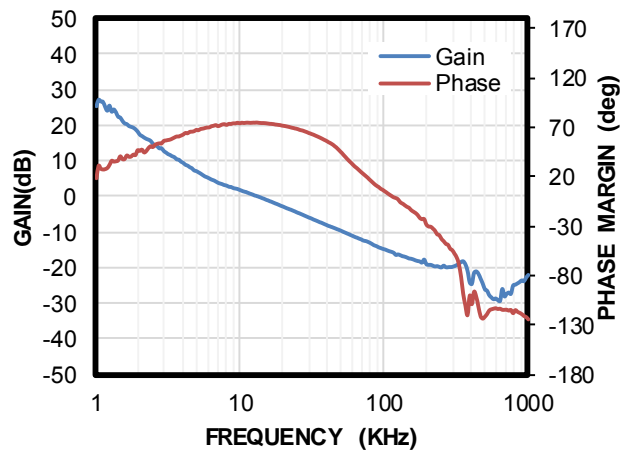

**Efficiency vs. Load Current**

$V_{out}=5V$ ,  $L=4.7\mu H$ ,  $DCR=8m\Omega$ ,  $F_{sw}=420kHz$

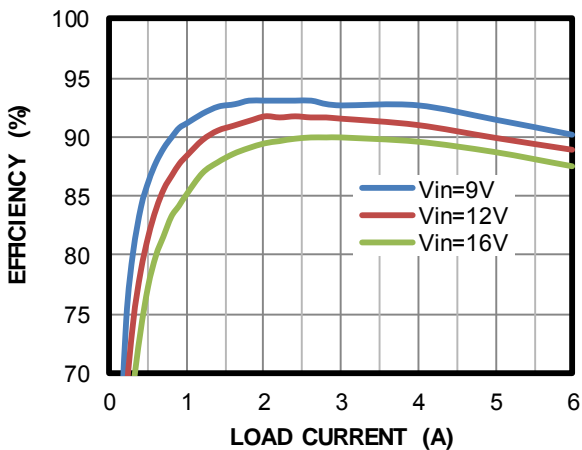

**Efficiency vs. Load current**

$V_{OUT}=9V$ ,  $L=4.7\mu H$ ,  $DCR=8m\Omega$ ,  $F_{sw}=420kHz$

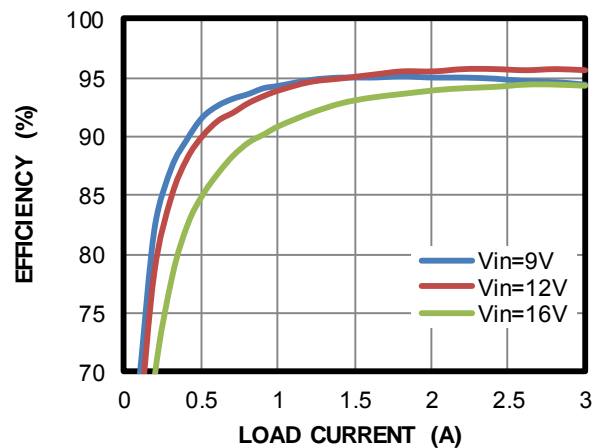

### TYPICAL PERFORMANCE CHARACTERISTICS

$V_{IN} = 12V$ ,  $V_{OUT} = 5V$ ,  $L = 4.7\mu H$ , Forced PWM mode,  $T_A = 25^\circ C$ , unless otherwise noted.

**Efficiency vs. Load Current**

$V_{OUT}=15V$ ,  $L=4.7\mu H$ ,  $DCR=8m\Omega$ ,  $F_{sw}=420kHz$

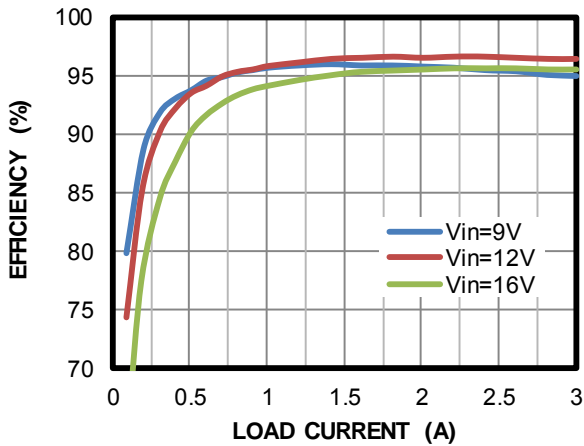

**Efficiency vs. Load Current**

$V_{OUT}=20V$ ,  $L=4.7\mu H$ ,  $DCR=8m\Omega$ ,  $F_{sw}=420kHz$

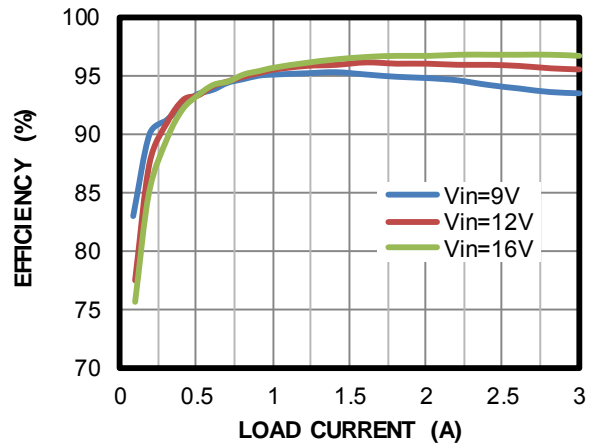

**Load Regulation vs. Load Current**

$V_{IN}=12V$ , no line drop compensation

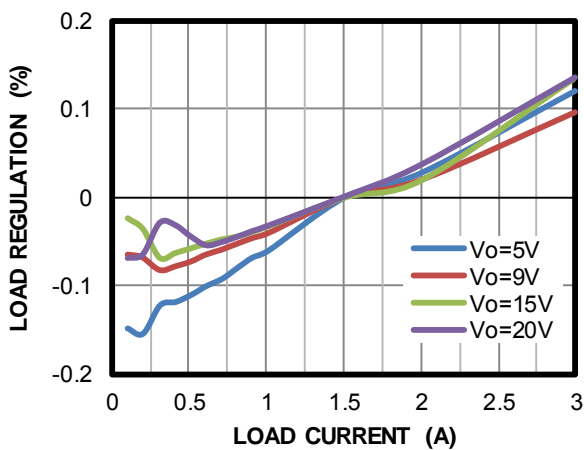

**Thermal Rise**

$V_{IN}=12V$ ,  $F_{sw}=420kHz$ , based on EV4245-VE-00A

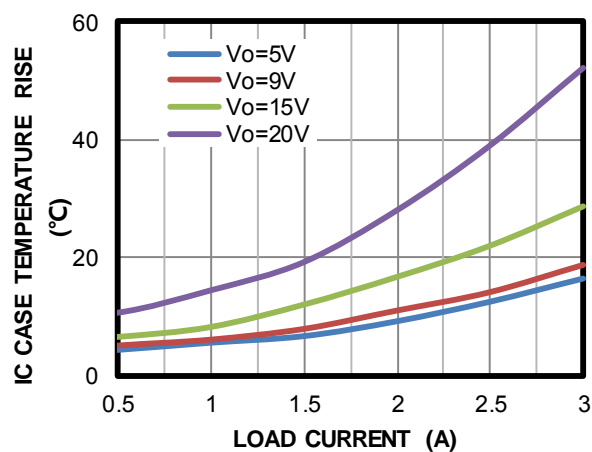

**TYPICAL PERFORMANCE CHARACTERISTICS (continued)**

$V_{IN} = 12V$ ,  $V_{OUT} = 5V$ ,  $L = 4.7\mu H$ , Forced PWM mode,  $T_A = 25^\circ C$ , unless otherwise noted.

**Output Ripple**

$V_{IN}=12V$ ,  $V_{OUT}=5V$ ,  $I_{OUT}=0A$ , PWM mode.

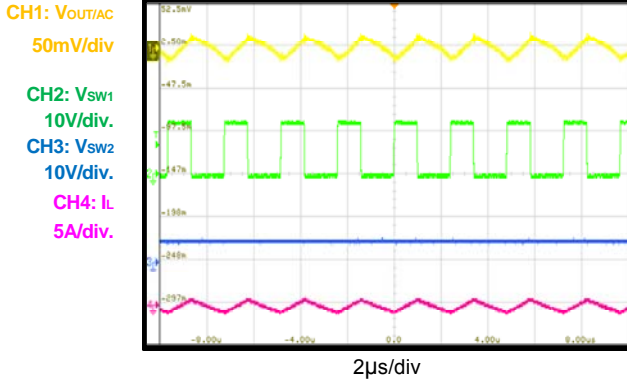

**Output Ripple**

$V_{IN}=12V$ ,  $V_{OUT}=5V$ ,  $I_{OUT}=3A$ , PWM mode.

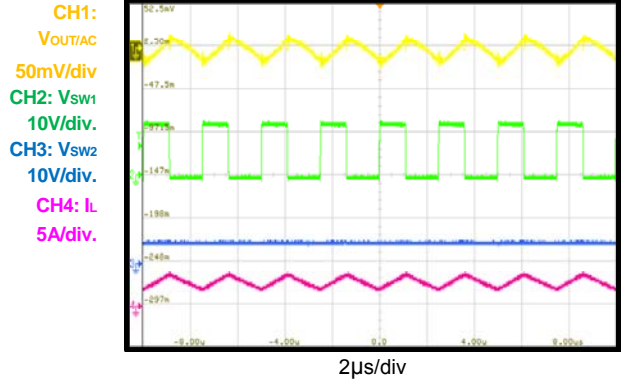

**Output Ripple**

$V_{IN}=12V$ ,  $V_{OUT}=9V$ ,  $I_{OUT}=0A$ , PWM mode.

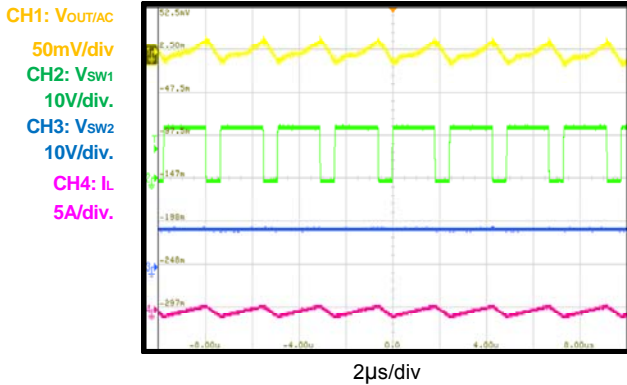

**Output Ripple**

$V_{IN}=12V$ ,  $V_{OUT}=9V$ ,  $I_{OUT}=3A$ , PWM mode.

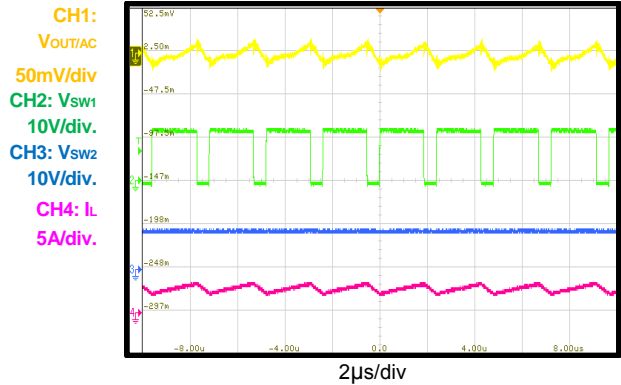

**Output Ripple**

$V_{IN}=12V$ ,  $V_{OUT}=12V$ ,  $I_{OUT}=0A$ , PWM mode.

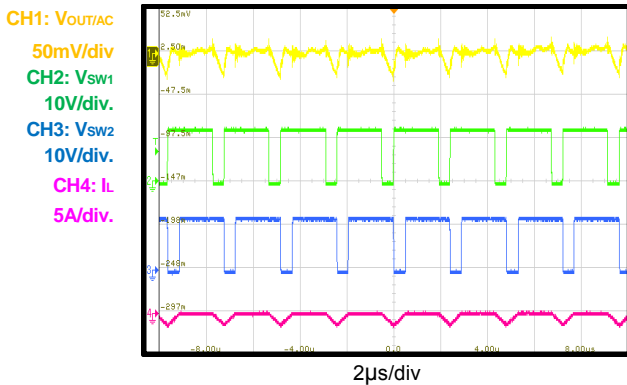

**Output Ripple**

$V_{IN}=12V$ ,  $V_{OUT}=12V$ ,  $I_{OUT}=3A$ , PWM mode.

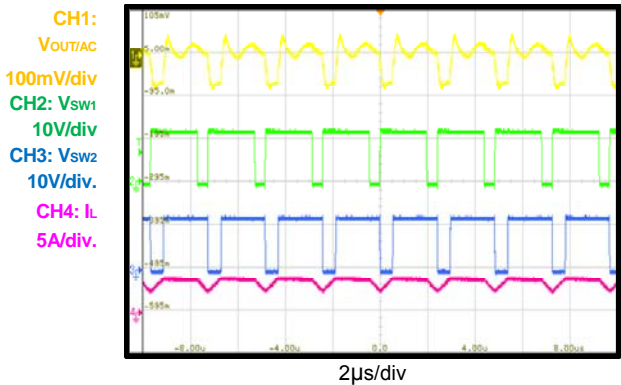

**TYPICAL PERFORMANCE CHARACTERISTICS (continued)**

$V_{IN} = 12V$ ,  $V_{OUT} = 5V$ ,  $L = 4.7\mu H$ , Forced PWM mode,  $T_A = 25^\circ C$ , unless otherwise noted.

**Output Ripple**

$V_{IN}=12V$ ,  $V_{OUT}=20V$ ,  $I_{OUT}=3A$ , PWM mode.

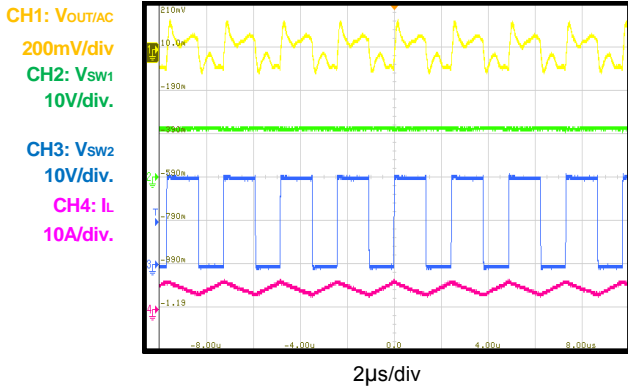

**Output Ripple**

$V_{IN}=12V$ ,  $V_{OUT}=20V$ ,  $I_{OUT}=0A$ , PWM mode.

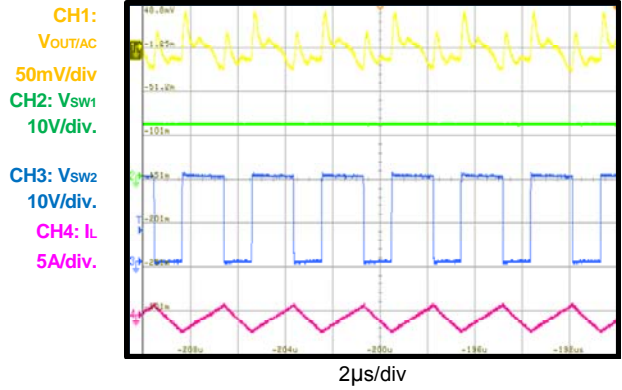

**I2C Operation On**

$V_{IN}=12V$ ,  $V_{OUT}=5V$ ,  $I_{OUT}=0A$

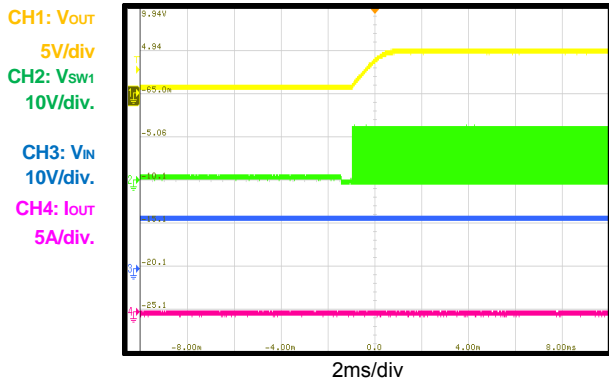

**I2C Operation Off**

$V_{IN}=12V$ ,  $V_{OUT}=5V$ ,  $I_{OUT}=0A$

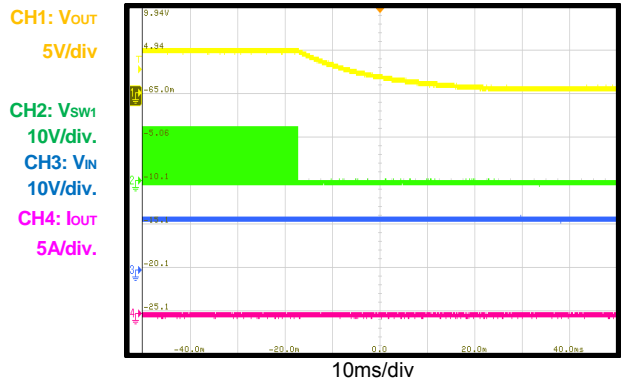

**I2C Operation On**

$V_{IN}=12V$ ,  $V_{OUT}=5V$ ,  $I_{OUT}=3A$

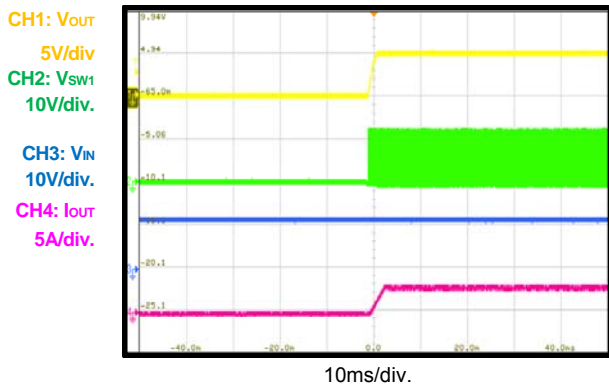

**I2C Operation Off**

$V_{IN}=12V$ ,  $V_{OUT}=5V$ ,  $I_{OUT}=3A$

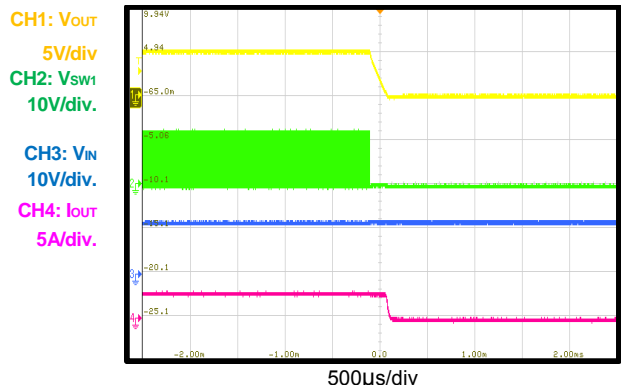

**TYPICAL PERFORMANCE CHARACTERISTICS (continued)**

$V_{IN} = 12V$ ,  $V_{OUT} = 5V$ ,  $L = 4.7\mu H$ , Forced PWM mode,  $T_A = 25^\circ C$ , unless otherwise noted.

**Output Voltage Transition**

$V_{IN}=12V$ ,  $V_{OUT}=5V$  to  $20V$ ,  $I_{OUT}=0A$

CH1:  $V_{out}$   
10V/div  
CH2:  $V_{sw1}$   
10V/div.  
CH3:  $V_{sw2}$   
10V/div.  
CH4:  $I_{out}$   
10A/div.

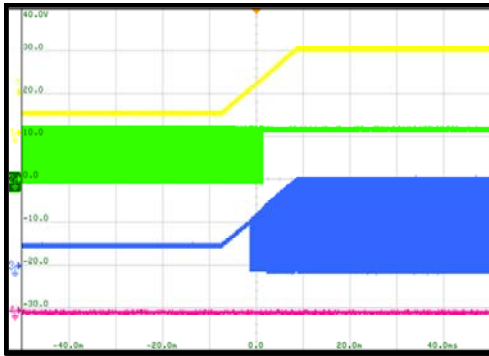

10ms/div.

**Output Voltage Transition**

$V_{IN}=12V$ ,  $V_{OUT}=20V$  to  $5V$ ,  $I_{OUT}=0A$

CH1:  $V_{out}$   
10V/div  
CH2:  $V_{sw1}$   
10V/div.  
CH3:  $V_{sw2}$   
10V/div.  
CH4:  $I_{out}$   
5A/div.

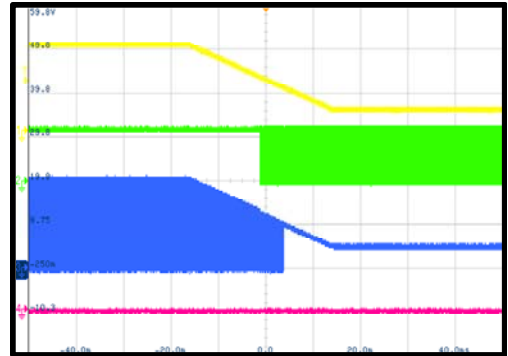

10ms/div.

**Output Voltage Transition**

$V_{IN}=12V$ ,  $V_{OUT}=5V$  to  $20V$ ,  $I_{OUT}=3A$

CH1:  $V_{out}$   
10V/div  
CH2:  $V_{sw1}$   
10V/div.  
CH3:  $V_{sw2}$   
10V/div.  
CH4:  $I_{out}$   
5A/div.

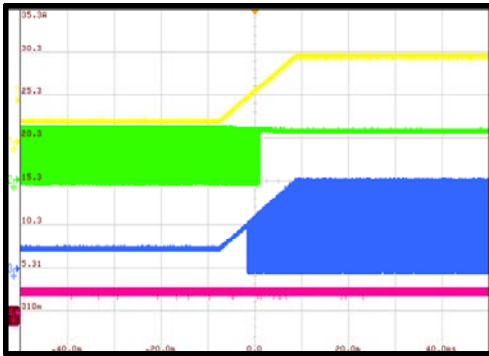

10ms/div

**Output Voltage Transition**

$V_{IN}=12V$ ,  $V_{OUT}=20V$  to  $5V$ ,  $I_{OUT}=3A$

CH1:  $V_{out}$   
10V/div  
CH2:  $V_{sw1}$   
10V/div.  
CH3:  $V_{sw2}$   
10V/div.  
CH4:  $I_{out}$   
10A/div.

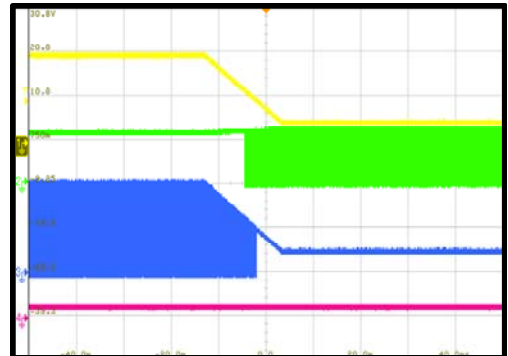

10ms/div

**Short Circuit Protection Entry**

$V_{IN}=12V$ ,  $V_{OUT}=5V$ ,  $I_{OUT}=3A$ , 500ms hiccup off time.

CH1:  $V_{out}$   
5V/div  
CH2:  $V_{sw1}$   
10V/div.  
CH3:  $V_{sw2}$   
10V/div.  
CH4:  $I_L$   
5A/div.

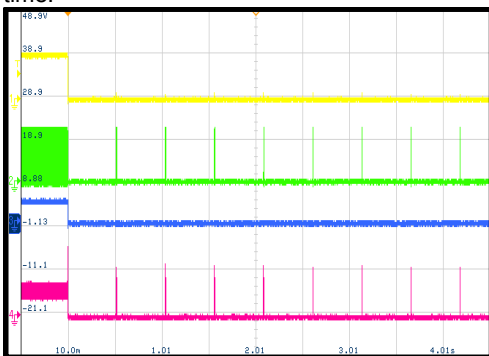

500ms/div

**Short Circuit Protection Recovery**

$V_{IN}=12V$ ,  $V_{OUT}=5V$ ,  $I_{OUT}=3A$ , 500ms hiccup off time.

CH1:  $V_{out}$   
5V/div  
CH2:  $V_{sw1}$   
10V/div.  
CH3:  $V_{sw2}$   
10V/div.  
CH4:  $I_L$   
5A/div.

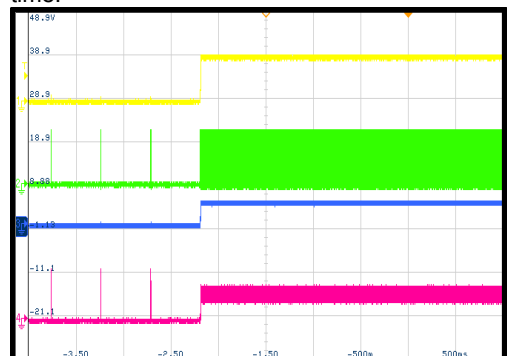

500ms/div



**TYPICAL PERFORMANCE CHARACTERISTICS (continued)**

$V_{IN} = 12V$ ,  $V_{OUT} = 5V$ ,  $L = 4.7\mu H$ , Forced PWM mode,  $T_A = 25^\circ C$ , unless otherwise noted.

**Constant Current Limit Protection**

$V_{IN}=12V$ ,  $V_{OUT}=5V$ , CR Load= $1\Omega$ , output current limit=3A

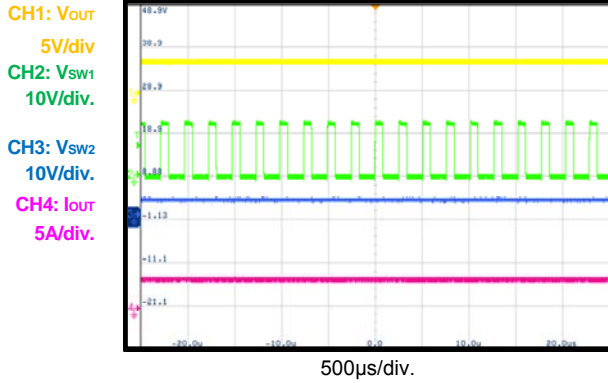

**CRL Load OCP**

$V_{IN}=12V$ ,  $V_{OUT}=5V$ , CC current limit=3A, ramp up CRL load slowly.

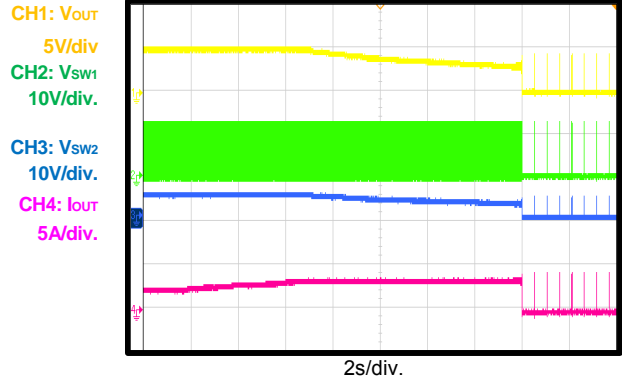

**OVP Recovery**

$V_{IN}=12V$ ,  $V_{OUT}=5V$ ,  $I_{OUT}=0A$ , remove 7V from  $V_{OUT}$

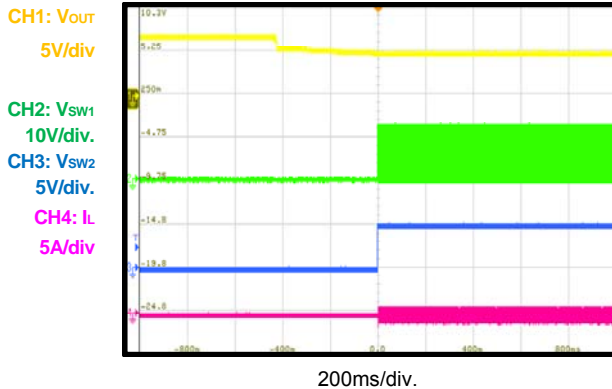

**Load Transient**

$V_{IN}=12V$ ,  $V_{OUT}=5V$ ,  $I_{OUT}=1.5A$  to  $3A$ , no line drop compensation.

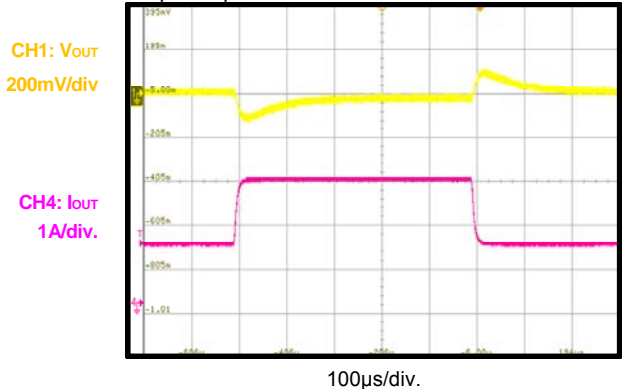

**OVP Entry**

$V_{IN}=12V$ ,  $V_{OUT}=5V$ ,  $I_{OUT}=0A$ , add 7V to  $V_{OUT}$

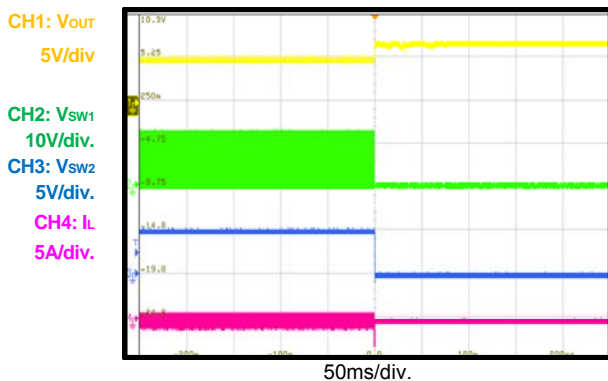

**EVALUATION BOARD LAYOUT**

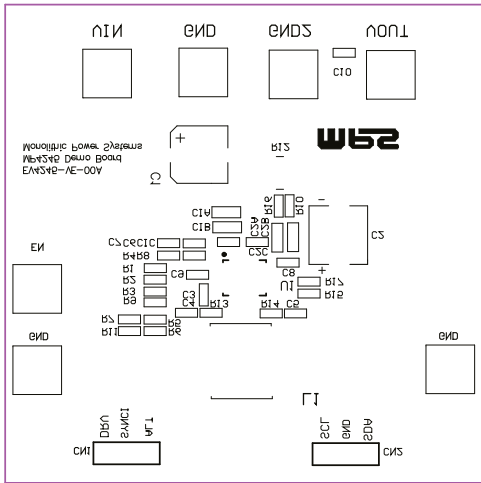

**Figure 1—Top Silk Layer**

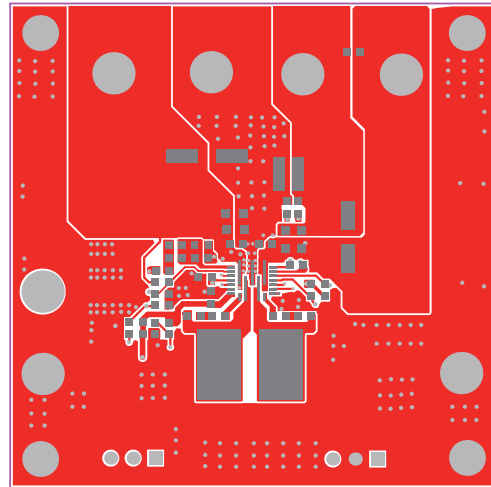

**Figure 2—Top Layer**

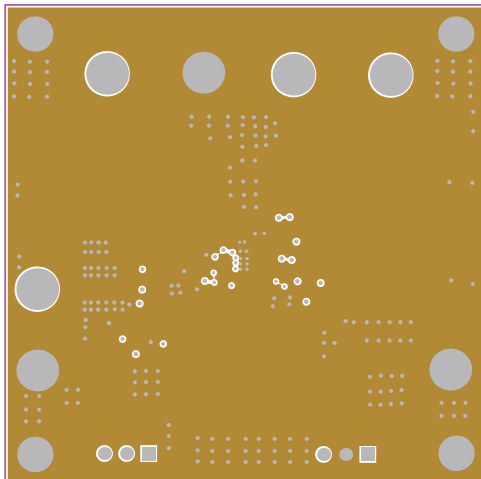

**Figure 3—Mid Layer 1**

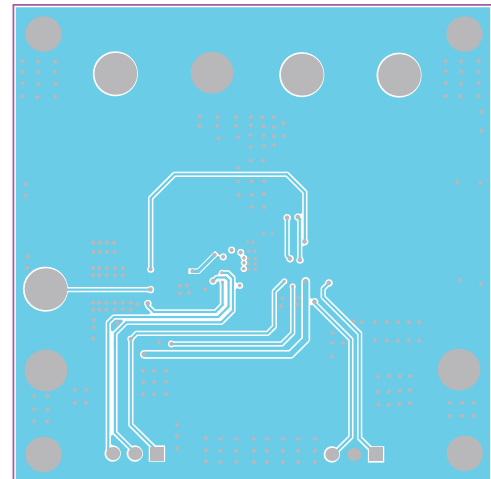

**Figure 4—Mid Layer 2**

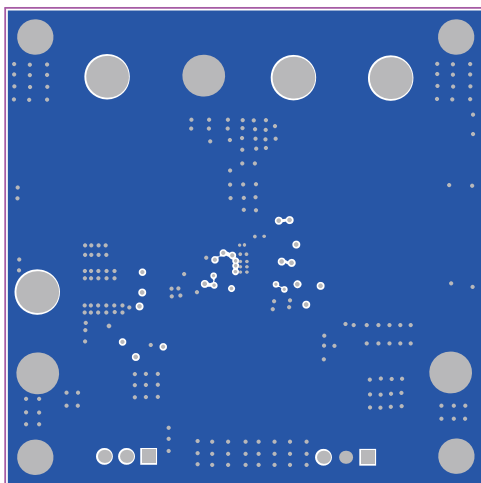

**Figure 5—Bottom Layer**

## QUICK START GUIDE

1. Preset the power supply output to 12V, and then turn off the power supply.
2. Connect the positive and negative terminals of the power supply output to the VIN and GND pins, respectively.
3. Turn the power supply on, the EV4245-VE-00A will startup automatically at VOUT=5V.
4. Output voltage can be adjusted by FB resistor, default FB reference voltage is 0.4V.
5. It can use I2C GUI to visit MP4245 register and adjust output voltage. Default I2C slave address is 61H.

**MTP-REGISTER VALUE SELECTED TABLE BY DEFAULT (MP4245-0001)**

OTP Items	Description	Default Value
OPERATION	MP4245 Default is On or OFF	<b>ON</b>
VOUT Voltage	Output voltage	5V
VOUT Scale Loop	1/(Vout Feedback Ratio)	0.08008
Dither Enable	Enable Frequency Spread Spectrum or not	Disable
GND_SENSE_RESISTOR	Current sense resistor value	20mΩ
Output OVP EN	Enable/Disable	Enable
Hiccup Timer	OCP off timer	500ms
Output Discharge EN	Enable/Disable	Enable
PFM/PWM Mode	Auto PFM/PWM or Forced PWM Mode	Forced PWM Mode
Current Limit	Output current limit	3.6A
DRV Voltage	Driver Pin output voltage(LDO output)	6V
Line Drop Compensation Gain	μA/A	<b>0</b>
OTP Threshold	Thermal Shutdown Protection Threshold	160°C
OTP Warning Threshold	Thermal Warning Threshold	120°C
VOUT MASK	Mask the ALT pin indication or not mask	NOT MASK
IOUT/POUT MASK		NOT MASK
INPUT MASK		MASK
Temperature MASK		NOT MASK
PG_STATUS MASK		NOT MASK
PG_ALT_EDGE MASK		NOT MASK
Other MASK		NOT MASK
Unknown Mask		NOT MASK
MTP Configuration code		MTP Configuration Code (defined by MPS)
MTP Revision Number	MTP software revision number (defined by MPS)	<b>0x00</b>

**NOTICE:** The information in this document is subject to change without notice. Users should warrant and guarantee that third party Intellectual Property rights are not infringed upon when integrating MPS products into any application. MPS will not assume any legal responsibility for any said applications.