

## DESCRIPTION

The EV4034-S-00B Evaluation Board demonstrates the capabilities of the MP4034: a primary-side-controlled, offline, LED lighting controller that eliminates secondary feedback components.

The EV4034-S-00B typically drives a 3.5W LED string with a 10V<sub>TYP</sub>, 350mA LED load from 85VAC to 265VAC at 50Hz.

The EV4034-S-00B has excellent efficiency and meets IEC61547 surge immunity and EN55015-conducted EMI requirements. It has multiple protections, including open-circuit protection, short-circuit protection, a cycle-by-cycle current limit, and over-temperature protection.

## ELECTRICAL SPECIFICATION

Parameter	Symbol	Value	Units
Input Voltage	V <sub>IN</sub>	85 to 265	VAC
Output Voltage	V <sub>OUT</sub>	10	V
LED Current	I <sub>LED</sub>	350	mA
Output Power	P <sub>OUT</sub>	3.5	W
Efficiency (full load)	η	>70	%

## FEATURES

- Primary-Side Control without Opto-Coupler and Secondary Feedback Circuit
- Precise Constant Current (CC)
- Integrated 700V MOSFET with Minimal External Components
- Variable, Off-Time, Peak-Current Control
- 600μA High-Voltage Current Source
- Up to 3.5W Output Power
- Over-Voltage Protection (OVP)
- Over-Temperature Protection (OTP)
- Open-Loop Protection (OLP)
- Natural Frequency Dithering for Improved EMI Signature
- Low Cost and Simple External Circuit
- Fits GU10 LED

## APPLICATIONS

- Solid-State Lighting
- Industrial & Commercial Lighting
- Residential Lighting

All MPS parts are lead-free and adhere to the RoHS directive. For MPS green status, please visit MPS website under Quality Assurance. "MPS" and "The Future of Analog IC Technology", are Registered Trademarks of Monolithic Power Systems, Inc.



**Warning:** Although this board is designed to satisfy safety requirements, the engineering prototype has not been agency approved. Therefore, all testing should be performed using an isolation transformer to provide the AC input to the prototype board.

**EV4034-S-00B EVALUATION BOARD**



**TOP VIEW**

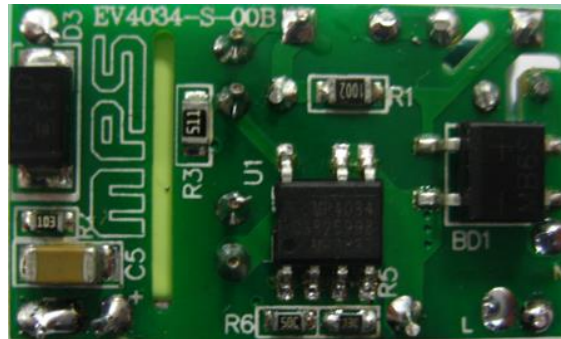

**BOTTOM VIEW**

(L x W x H) 27mm x 16mm x 16mm

Board Number	MPS IC Number
EV4034-S-00B	MP4034GS

EVALUATION BOARD SCHEMATIC

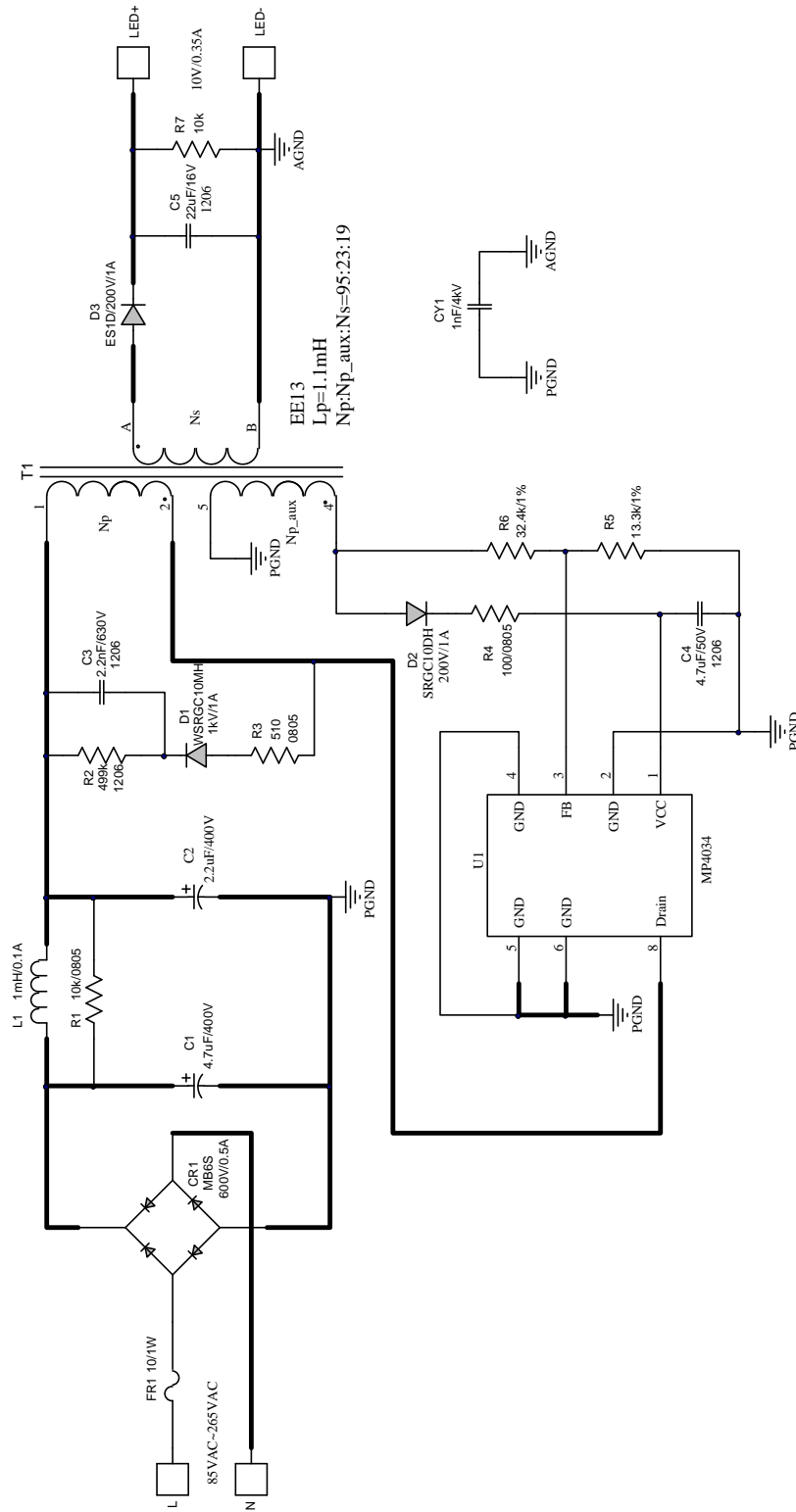

Figure 1: Schematic

PCB LAYOUT

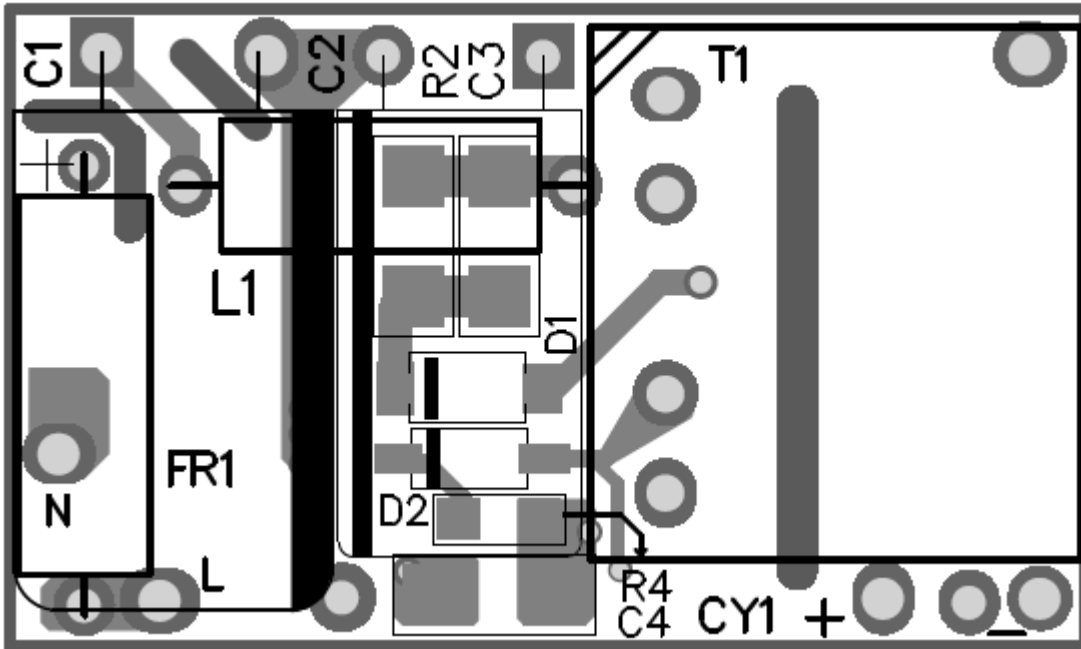

Figure 2: Top Layer

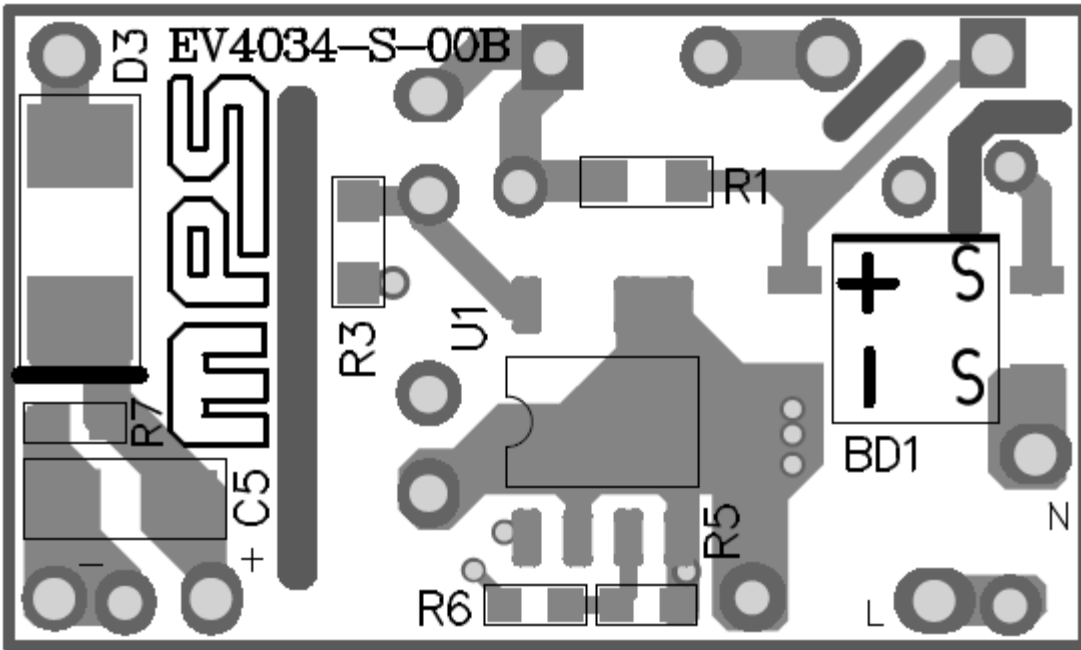

Figure 3: Bottom Layer

## CIRCUIT DESCRIPTION

The EV4034-S-00B is configured for a single-stage, flyback topology. It uses primary-side-control to simplify the schematic and reduce BOM costs. It can also achieve an accurate LED current.

The input stage consists of FR1 and DB1. FR1 protects against component failure or some excessive short events, and can restrain the inrush current.

The  $\pi$  filter (C1, L1, and C2) guarantees that the conducted EMI meets the EN55015 standard. The snubber circuit (R2, R3, D1, and C3) reduces the drain-source voltage spike.

R4, C4, and D2 provide the VCC power supply.

The resistor divider (R5 and R6) provides open-lamp protection by sampling the voltage on the primary auxiliary winding. When an open occurs, the output voltage remains constant.

CY1 is a Y capacitor that lowers common-mode noise to ensure a sufficient EMI margin. T1 is the power transformer, the structure of which is also very important to pass EMI test.

D3, C5, and R7 compose output circuit. D3 is a Schottky diode for better efficiency. C5 is a ceramic capacitor for lower output-voltage ripple and R7 is the dummy load for open-lamp protection.

**EV4034-S-00B BILL OF MATERIALS**

Qty	Ref	Value	Description	Package	Manufacturer	Manufacturer_PN
1	C1	4.7μF	Electrolytic Capacitor; 400V;	DIP	Lvbaoshi	4.7μF/400V
1	C2	2.2μF	Electrolytic Capacitors; 400V;	DIP	Lvbaoshi	2.2μF/400V
1	C3	2.2nF	Ceramic Capacitor; 630V;X7R	1206	Murata	GRM31BR72J222KW01
1	C4	4.7μF	Ceramic Capacitor; 50V;X7R;	1206	Murata	GRM31CR71H475KA12L
1	C5	22μF	Ceramic Capacitor; 16V;X5R	1206	Murata	GRM31CR61C226ME15L
1	CR1	MB6S	Diode;600V;0.5A;	SOIC-4	TaiWan Semiconductor	MB6S
1	CY1	1nF	Y Capacitor;4kV;20%;	DIP	Hongke	JNK09E102MY02N
1	D1	WSRGC 10MH	Diode;1kV;1A	1206	Zowie	WSRGC10MH
1	D2	SRGC1 0DH	Diode;200V;1A;	1206	Maxmega	SRGC10DH
1	D3	ES1D	Diode;200V;1A;	SMA	Taiwan Semiconductor	ES1D
1	FR1	10	Fuse Resistor;5%;1W;	DIP	Yageo	FKN1WSJT-52-10R
1	L1	1mH	Inductor;17.4Ω;0.1A	DIP	Bangdayuan	CKL0410-102
1	R1	10kΩ	Film Resistor;1%;1/8W;	0805	Yageo	RC0805FR-0710KL
1	R2	499kΩ	Film Resistor;1%;1/4W;	1206	Yageo	RC1206FR-07499KL
1	R3	510Ω	Film Resistor;5%;1/8W	0805	LIZ	0805 J 510R
1	R4	100Ω	Resistor;5%;1/8W;	0805	Any	CR05T05NJ100R
1	R5	13.3kΩ	Film Resistor;1%;	0603	Yageo	RC0603FR-0713R3L
1	R6	32.4kΩ	Film Resistor;1%;	0603	Yageo	RC0603FR-0732K4L
1	R7	10kΩ	Film Resistor;5%;	0603	Yageo	RC0603JR-0710K
1	T1	1.1mH	EE13; Np:Np_aux:Ns=95:23:19;	DIP	Yimei	FX0282
1	U1	MP4034	Primary-Side CC Regulator	SOIC8-7A	MPS	MP4034GS

## TRANSFORMER SPECIFICATION

### Electrical Diagram

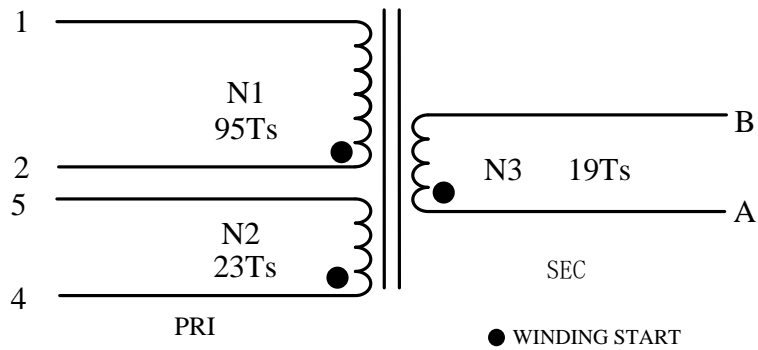
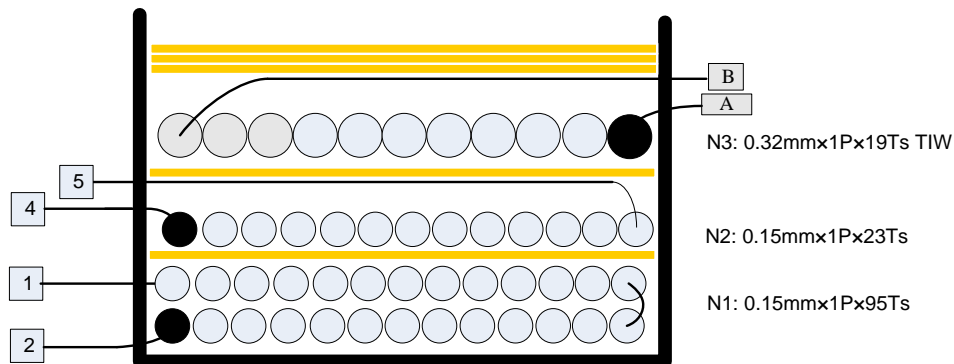

**Figure 4: Transformer Diagram**

**Notes:**

1. N3 is with Triple Isolation Wire. A and B ends are both flying leads and need to be marked with different color.

### Winding Diagram



**Figure 5: Winding Diagram**

**Winding Order**

Winding No.	Tape Layer Number	Start & End	Magnet WireΦ(mm)	Turns
N1	1	2→1	0.15mm * 1	95
N2	1	4→5	0.15mm * 1	23
N3	3	A→B	0.32mm(T.I.W) * 1	19

**Electrical Specifications**

<b>Electrical Strength</b>	60 second, 60Hz, from PRI. to SEC.	3600VAC
	60 second, 60Hz, from PRI. to CORE.	500VAC
	60 second, 60Hz, from SEC. to CORE.	3600VAC
<b>Primary Inductance</b>	Pins 1 - 2, all other windings open, measured at 50kHz, 0.1 VRMS	1.1mH±8%
<b>Primary Leakage Inductance</b>	Pins 1 - 2 with all other pins shorted, measured at 50kHz. 0.1 VRMS	33μH±10%

**Materials**

Item	Description
1	Core: EE13, UI=2500±25%, AL=108.4nH/N <sup>2</sup> ±3% GAPPED, ACME P4 or equivalent
2	Bobbin: EE13, 5+5PIN 1 SECT TH, UL94V-0
3	Wire:Φ0.15mm,, 2UEW, Class B
4	Triple Insulation Wire: Φ0.20mm TRW
5	Tape: 8.0mm(W)×0.06mm(TH)
6	Varnish: JOHN C. DOLPH CO, BC-346A or equivalent
7	Solder Bar: CHEN NAN: SN99.5/Cu0.5 or equivalent

## EVB TEST RESULTS

### Performance Data

#### Efficiency

$f$ (Hz)	Vin (VAC)	Pin (W)	Vout (V)	Iout (mA)	Pout (W)	Efficiency (%)
60	85	4.19	9.05	346	3.13	74.7
	115	4.11	9.05	348	3.15	76.6
	150	4.08	9.06	349	3.16	77.5
50	180	4.09	9.06	349	3.16	77.3
	210	4.14	9.06	351	3.18	76.8
	230	4.12	9.02	347	3.13	76.0
	265	4.16	9.03	345	3.12	75.0

Efficiency vs. Input Line Voltage

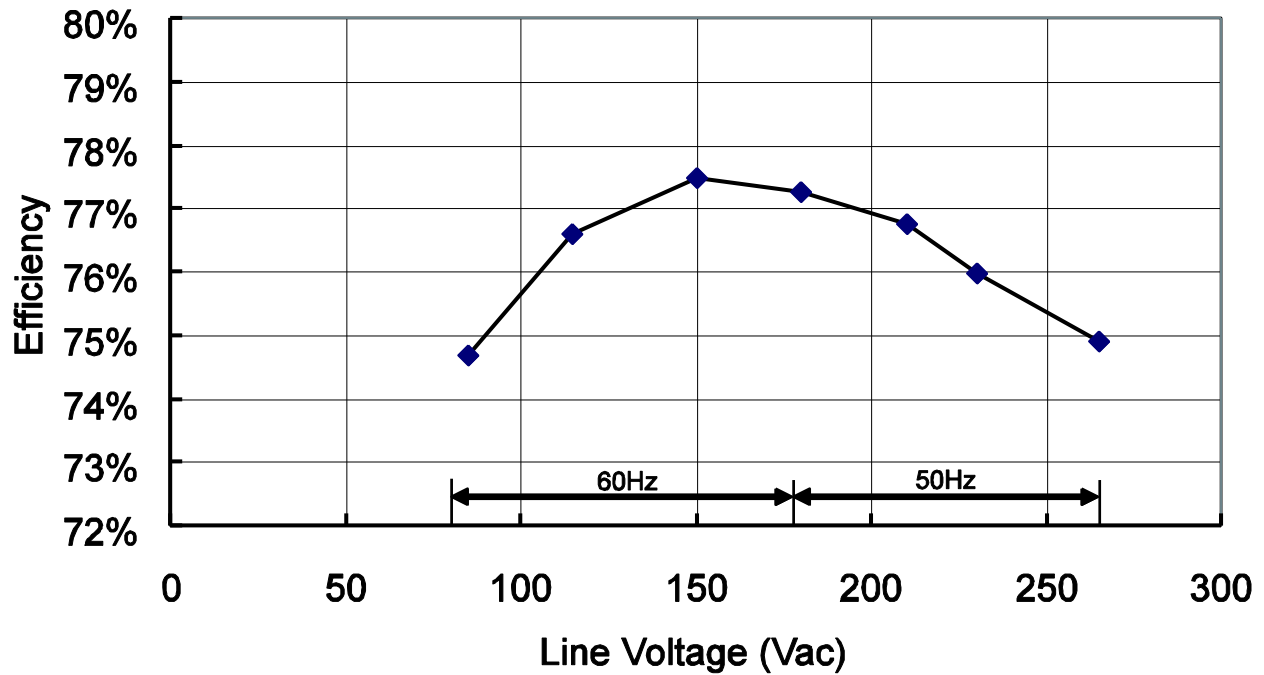

### Line Regulation

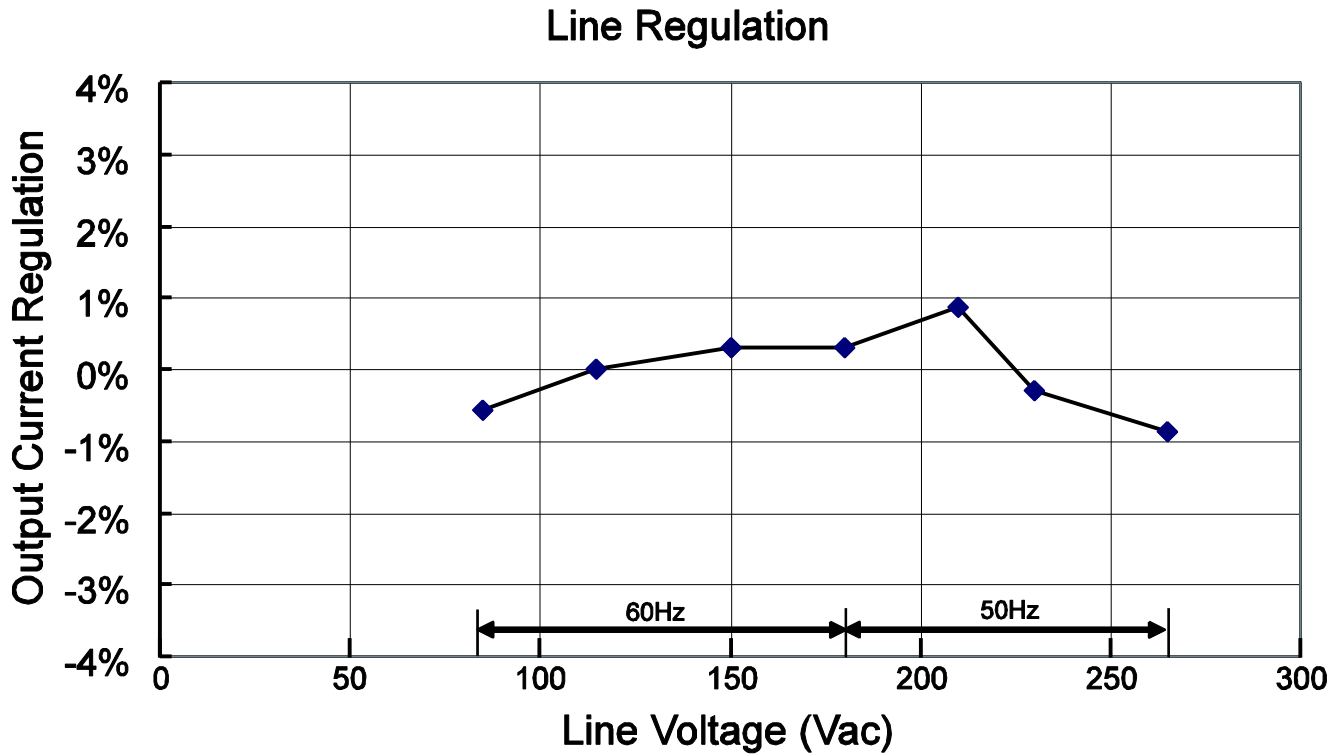

### Surge Test

Line-to-Line 500V and Line-to-Power-Earth 1kV surge testing was completed according to IEC61547. Input voltage was set at 230VAC/50Hz. Output was loaded at full load and operation was verified following each surge event.

Surge Level (V)	Input Voltage (VAC)	Injection Location	Injection Phase (°)	Test Result (Pass/Fail)
500	230	L to N	90	Pass
-500	230	L to N	270	Pass
1000	230	L to PE	90	Pass
-1000	230	L to PE	270	Pass
1000	230	N to PE	90	Pass
-1000	230	N to PE	270	Pass

### Conducted EMI Test

#### Conducted EMI Test

110Vac, 60Hz, Maximum Load,  
L Line, EN55015 Limits

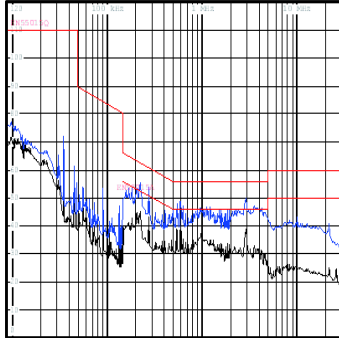

#### Conducted EMI Test

110Vac, 60Hz, Maximum Load,  
N Line, EN55015 Limits

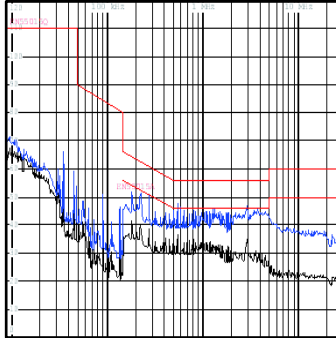

#### Conducted EMI Test

220Vac, 50Hz, Maximum Load,  
L Line, EN55015 Limits

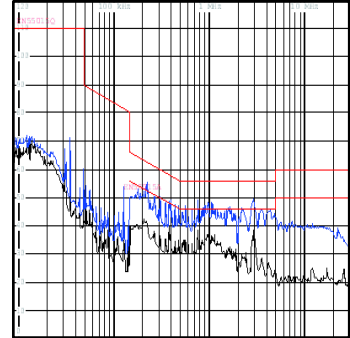

#### Conducted EMI Test

220Vac, 50Hz, Maximum Load,  
N Line, EN55015 Limits

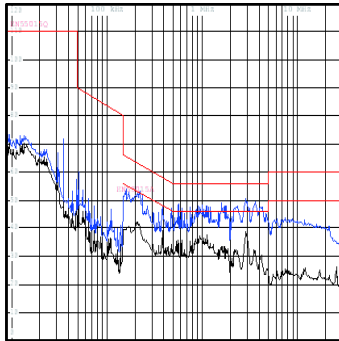

**Thermal Test**

Test with 85Vac input and full load condition.

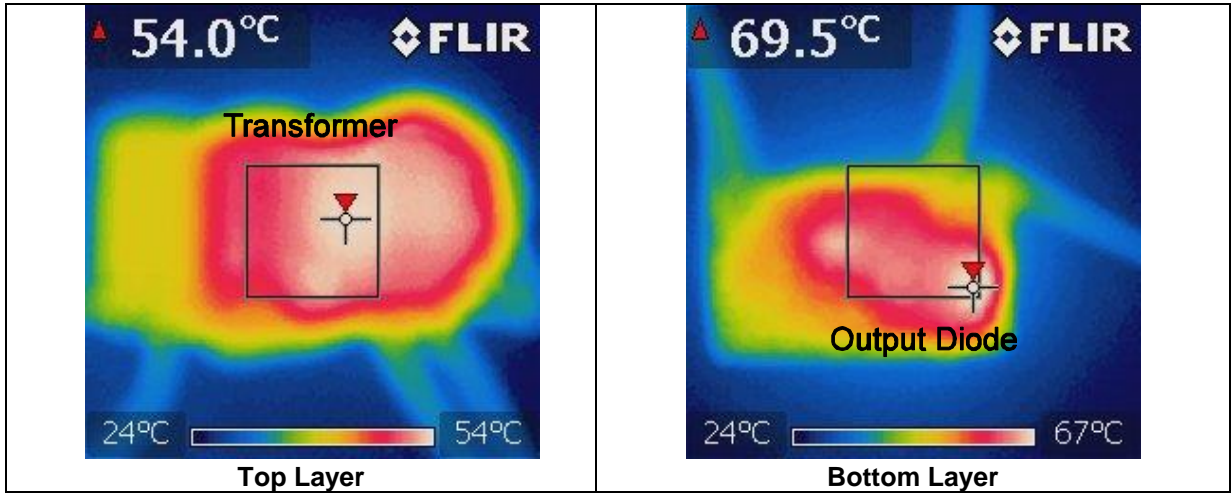

## EVB TEST RESULTS

Performance waveforms are tested on the evaluation board.

$V_{IN}=110VAC/60Hz$ , 3 LEDs in series,  $I_{LED}=350mA$ ,  $V_{OUT}=10V$ ,  $L_P=1.1mH$ ,  $N_P:N_S:N_{P\_AUX}=95:19:23$

### Steady State

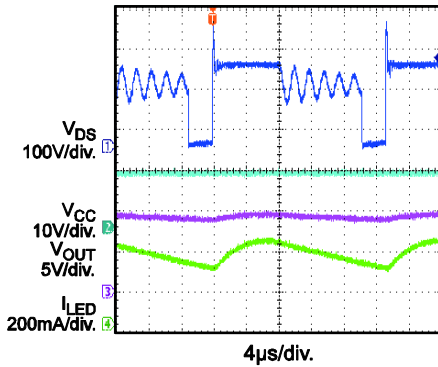

### Turn On Delay

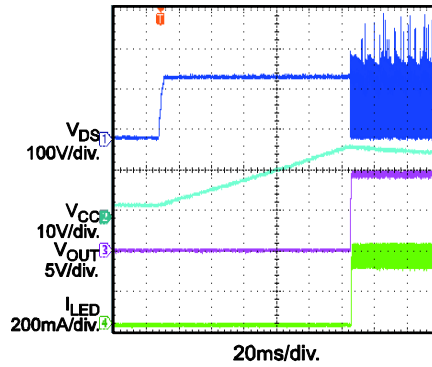

### Output Rise Time

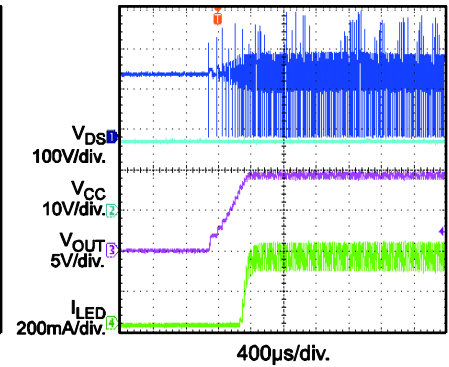

### Output Ripple

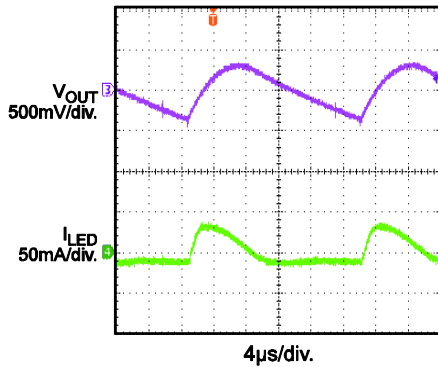

### SCP Enter

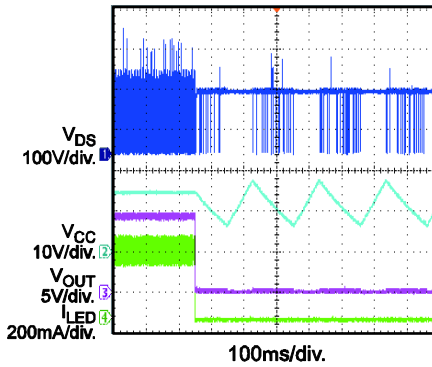

### SCP Recovery

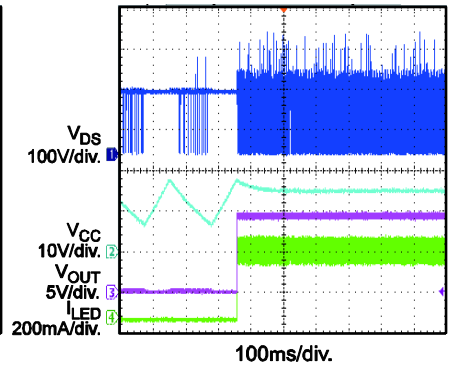

### SCP Steady State

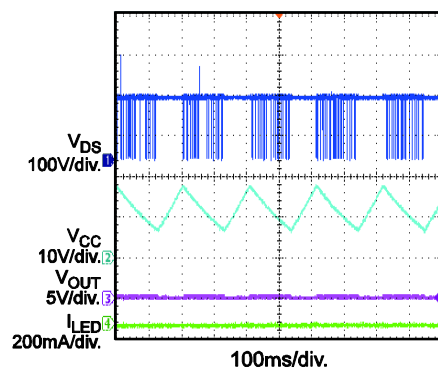

### SCP Start Up

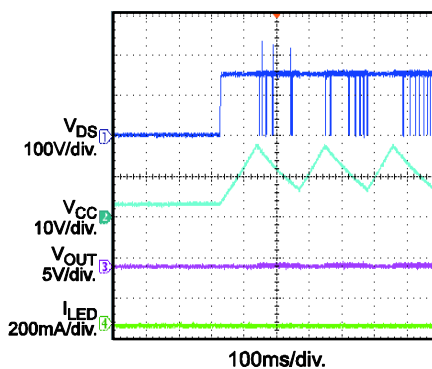

### Lamp Open Protection

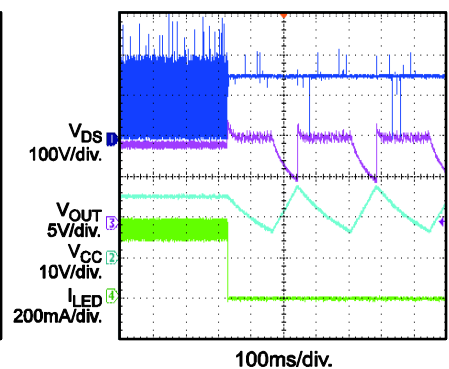

## EVB TEST RESULTS *(continued)*

Performance waveforms are tested on the evaluation board.

$V_{IN}=220VAC/50Hz$ , 3 LEDs in series,  $I_{LED}=350mA$ ,  $V_{OUT}=10V$ ,  $L_P=1.1mH$ ,  $N_P:N_S:N_{P\_AUX}=95:19:23$ .

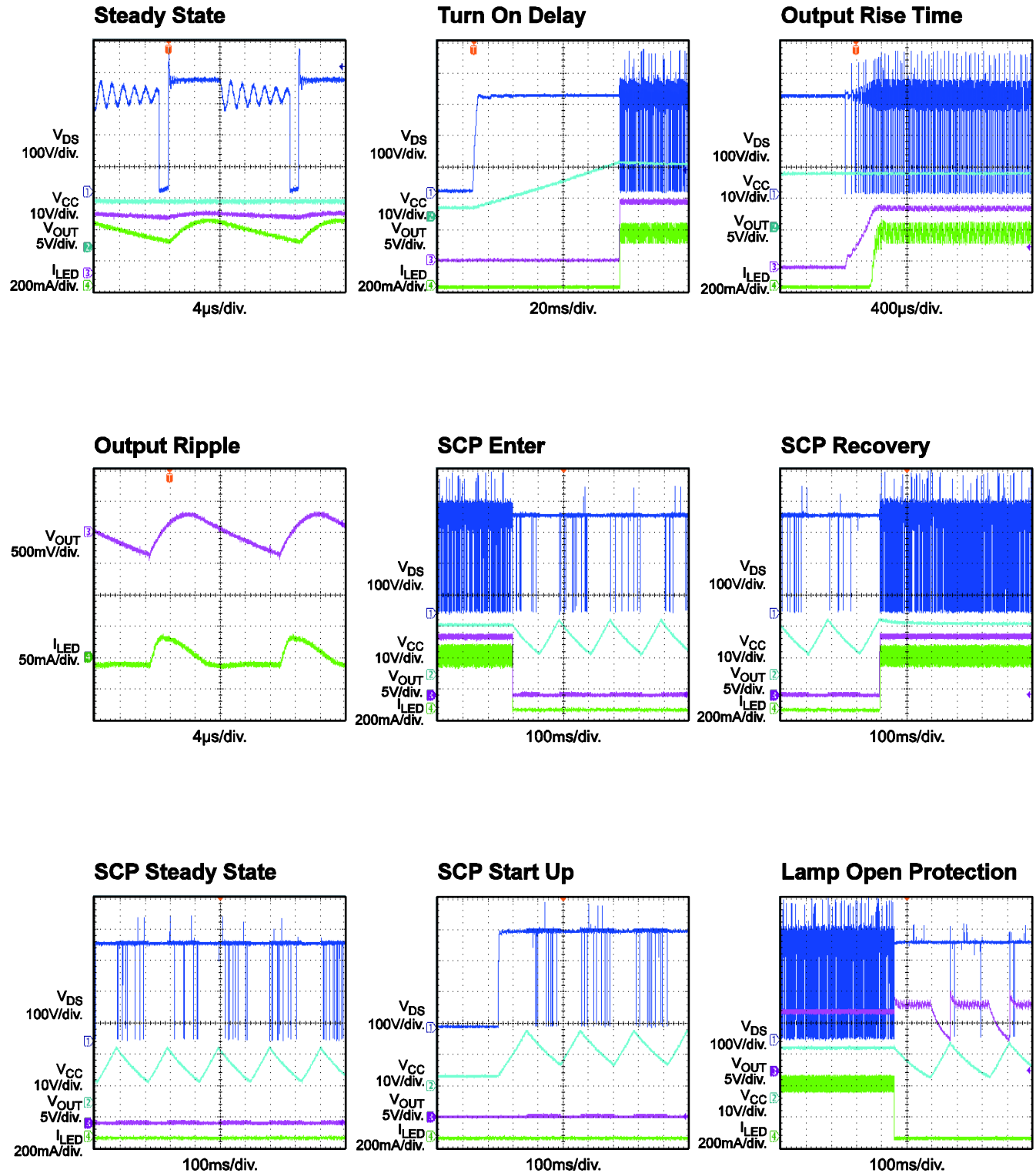

## QUICK START GUIDE

1. Preset AC Power Supply to  $85\text{VAC} \leq V_{\text{IN}} \leq 265\text{VAC}$ .
2. Turn Power Supply off.
3. Connect the LED string between “LED+” (anode of LED string) and “LED-” (cathode of LED string).
4. Connect Power Supply terminals to AC  $V_{\text{IN}}$  terminals as shown on the board.
5. Turn AC Power Supply on after making connections.

**NOTICE:** The information in this document is subject to change without notice. Please contact MPS for current specifications. Users should warrant and guarantee that third party Intellectual Property rights are not infringed upon when integrating MPS products into any application. MPS will not assume any legal responsibility for any said applications.