

DESCRIPTION

EV3415-G-00A Evaluation Board is designed to demonstrate the capability of MP3415. The MP3415 is a high-efficiency, synchronous, current-mode, step-up converter with output disconnect.

The MP3415 provides inrush current limiting and output short-circuit protection. The integrated, P-channel, synchronous rectifier improves efficiency and eliminates the need for an external Schottky diode. The PMOS disconnects the output from the input when the part shuts down.

The 1MHz switching frequency allows for small external components, while the internal compensation and the soft-start minimize the external component count. The MP3415 is available in a small 12-pin QFN 2mm x 2mm package.

Electrical Specification

Parameter	Symbol	Value	Units
Input Voltage	V_{IN}	1.8-4.5 ⁽¹⁾	V
Output Voltage	V_{OUT}	5	V
Output Current	I_{OUT}	1.5	A

Note:

1) This board can supply 5V/1.5A load from 2.8V-4.5V input power, it can work with lower than 2.8V input, but the load capability is lower than 1.5A.

FEATURES

- 1.8V to 4.5V Board Input
- Program up to 5.5V Output Voltage
- Internal Synchronous Rectifier
- 1MHz Fixed Frequency Switching
- 22 μ A Quiescent Current
- <1 μ A Shutdown Current
- True Output Disconnect from Input
- Up to 97% Efficiency
- High Efficiency over Full-Load Range
- Internal Compensation, Inrush Current Limiting, and Internal Soft-Start
- Tiny External Components
- OVP, SCP, and OTP
- Small 2x2mm QFN12 Package

APPLICATIONS

- Two-cell and Three-cell Alkaline, NiCd or NiMH or Single-cell Li Battery Consumer Products
- Personal Medical Devices
- Portable Media Players
- Wireless Peripherals
- Handheld Computers and Smart phones

All MPS parts are lead-free, halogen free, and adhere to the RoHS directive. For MPS green status, please visit MPS website under Quality Assurance.

"MPS" and "The Future of Analog IC Technology" are Registered Trademarks of Monolithic Power Systems, Inc.

EV3415-G-00A EVALUATION BOARD

TBD

(L x W x H) 6.35cm x 6.35cm x 0.6cm

Board Number	MPS IC Number
EV3415-G-00A	MP3415GG

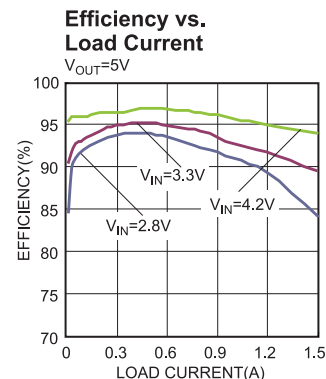

EVALUATION BOARD SCHEMATIC

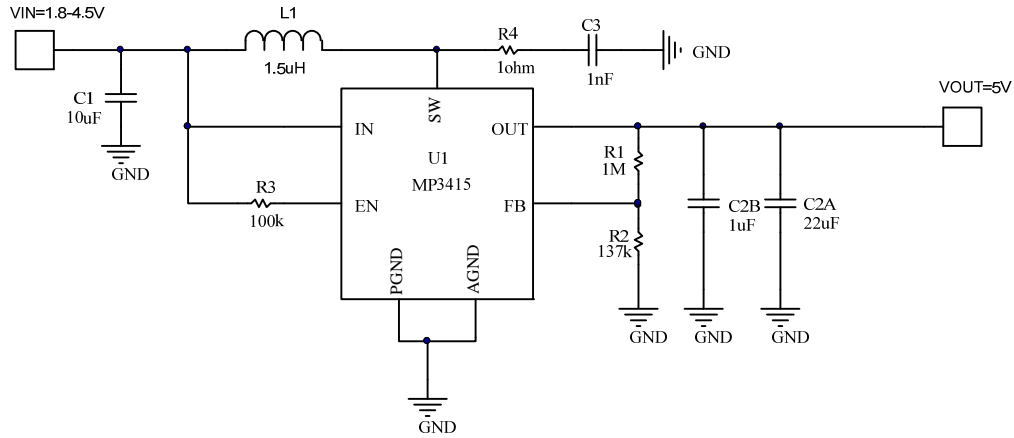

T-EV3415-G-00A BILL OF MATERIALS

Qty	Ref	Value	Description	Package	Manufacturer	Part Number
1	C1	10uF	Ceramic Cap.,10V,X7R	1210	muRata	GRM32ER71A106KA01L
1	C2A	22uF	Ceramic Cap.,10V,X7R	1210	muRata	GRM32ER71A226KE20L
1	C2B	1uF	Ceramic Cap.,10V,X7R	0603	muRata	GRM188R71A105KA61D
1	C3	1nF	Ceramic Cap.,50V,X7R	0603	muRata	GRM188R71H102KA01D
1	R1	1M	Film Res.,1%	0603	ROYAL	RC0603FR-071ML
1	R2	137k	Film Res.,1%	0603	ROYAL	RC0603FR-07137KL
1	R3	100k	Film Res.,5%	0603	ROYAL	RC0603JR-07100KL
1	R4	1Ω	Film Res.,1%	0603	ROYAL	RC0603FR-071RL
1	L1	1.5uH	IR=11A,Isat=14A, DCR=6.6mΩ	SMD	Wurth	744 311 150
1	U1		3.6A, 1MHz Synchronous Step-up Converter	QFN 2mm*2mm	MPS	MP3415GG

EVB TEST RESULTS

$V_{IN} = 3.3V$, $V_{OUT} = 5V$, $L = 1.5\mu H$, $T_A = 25^\circ C$, unless otherwise noted.

Efficiency vs. Load Current

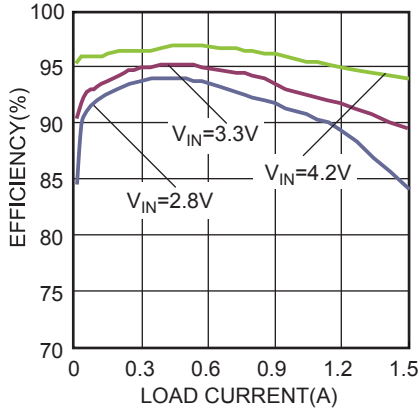

Load Regulation

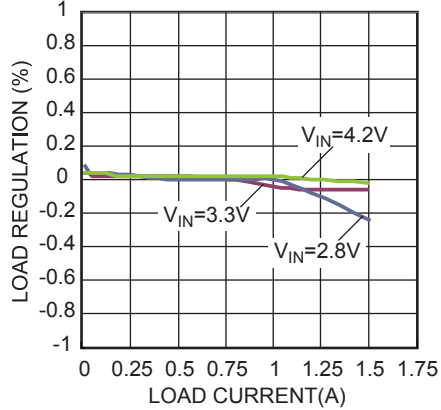

Line Regulation

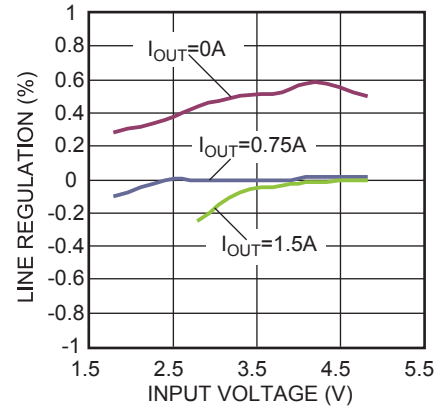

Case Temperature Rise vs. Load Current

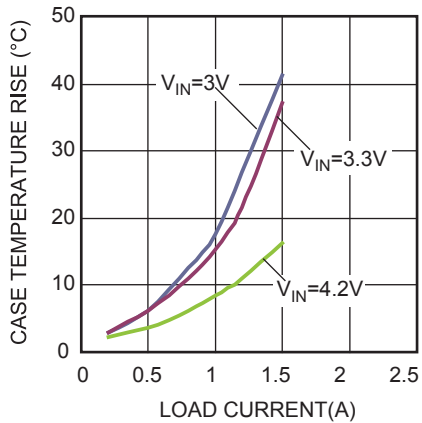

Bode Plot

$V_{IN}=3.3V$, $V_{OUT}=5V$, $I_{OUT}=1.5A$

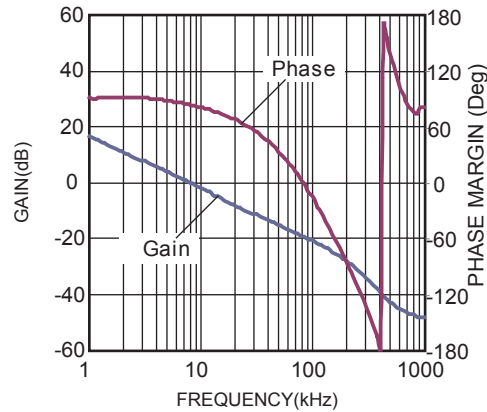

EVB TEST RESULTS (continued)

$V_{IN} = 3.3V$, $V_{OUT} = 5V$, $L = 1.5\mu H$, $T_A = 25^\circ C$, unless otherwise noted.

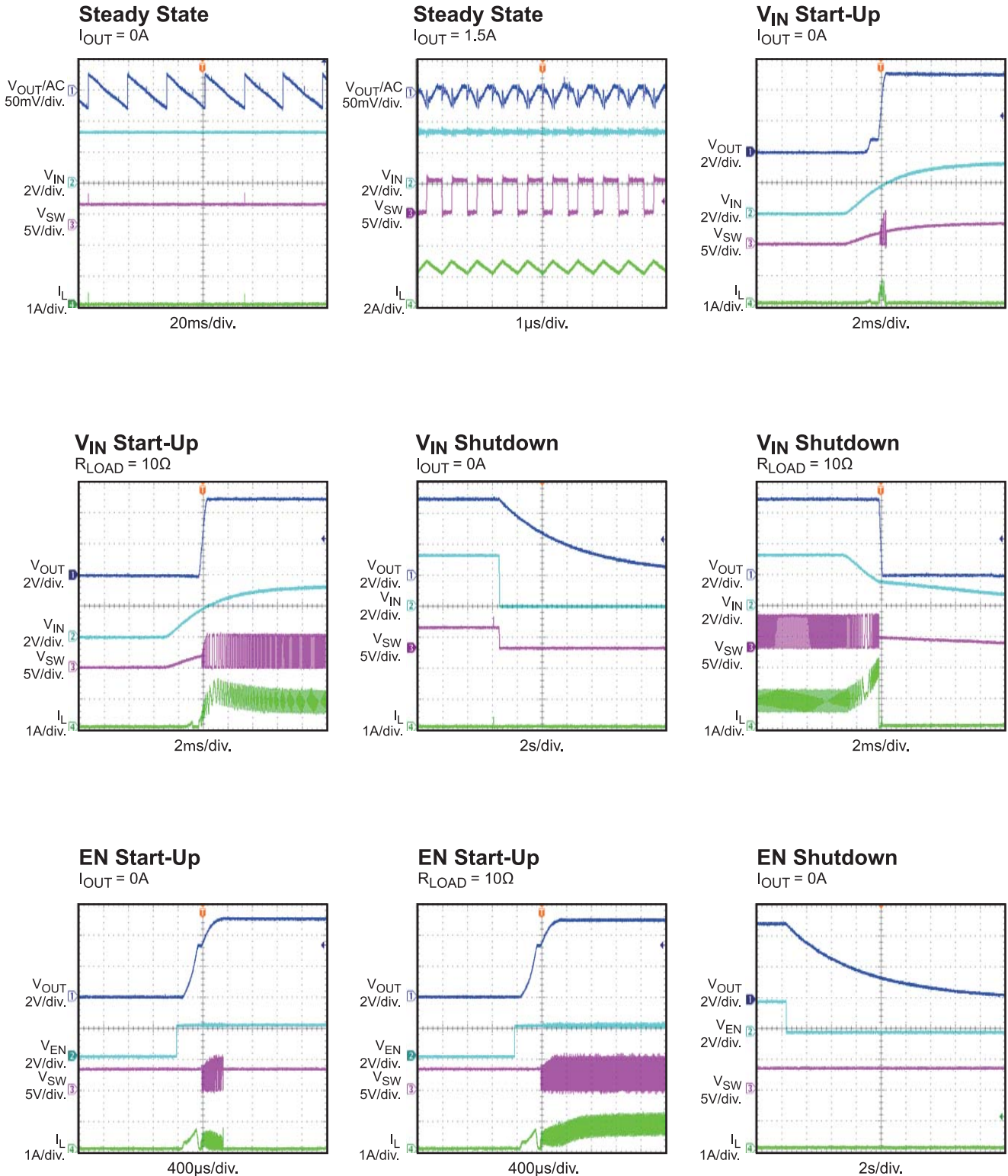

EVB TEST RESULTS (continued)

$V_{IN} = 3.3V$, $V_{OUT} = 5V$, $L = 1.5\mu H$, $T_A = 25^\circ C$, unless otherwise noted.

EN Shutdown

$R_{LOAD} = 10\Omega$

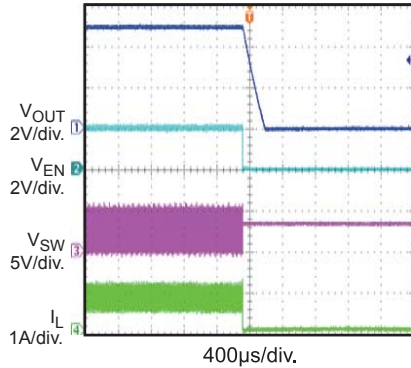

SCP Entry

$I_{OUT} = 0A$ to Short

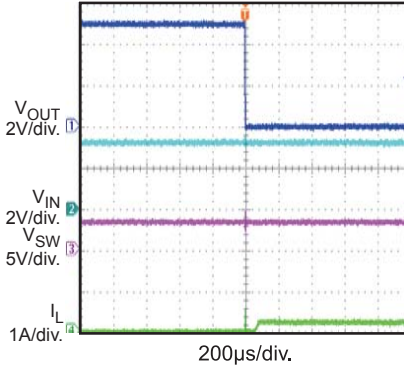

SCP Entry

$R_{LOAD} = 10\Omega$ to Short

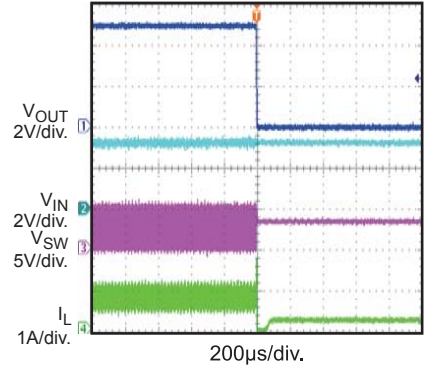

SCP Recovery

$I_{OUT} = \text{Short to } 0A$

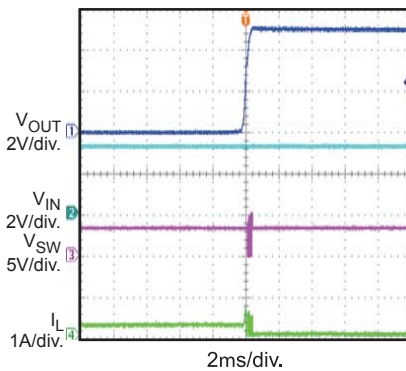

SCP Recovery

$R_{LOAD} = \text{Short to } 10\Omega$

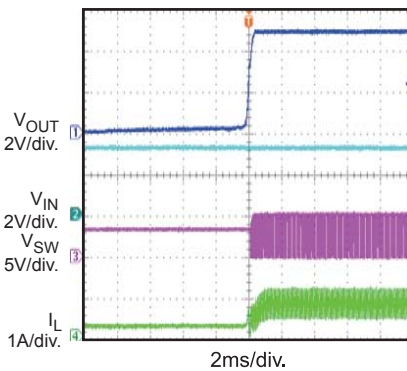

Load Transient

$I_{OUT} = 0A$ to $0.75A$
 $di/dt = 100mA/\mu s$

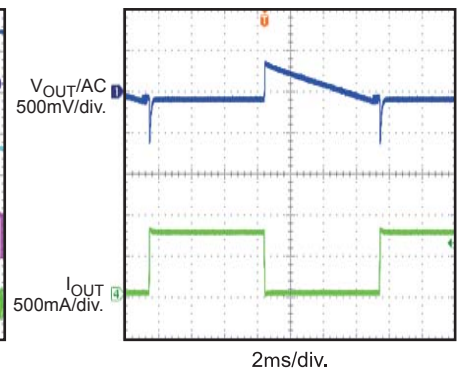

Load Transient

$I_{OUT} = 0.75A$ to $1.5A$
 $di/dt = 100mA/\mu s$

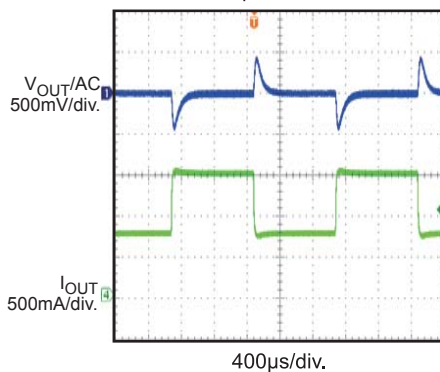

PRINTED CIRCUIT BOARD LAYOUT

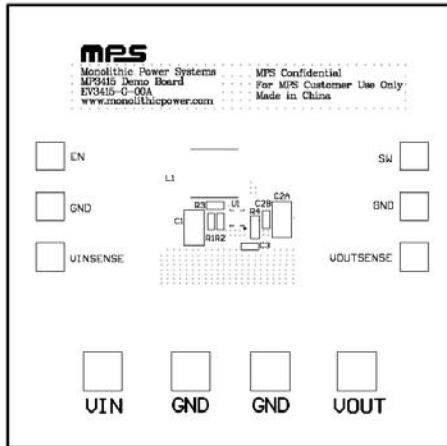

Figure 1—Top Silk Layer

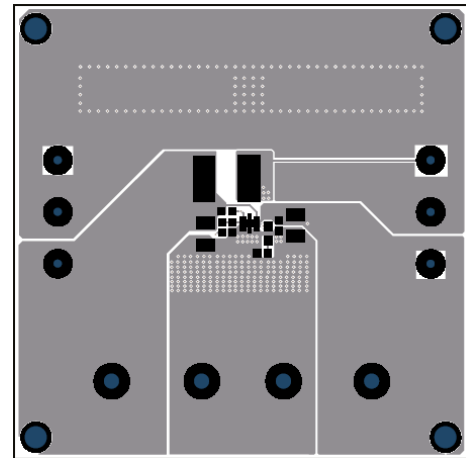

Figure 2—Top Layer

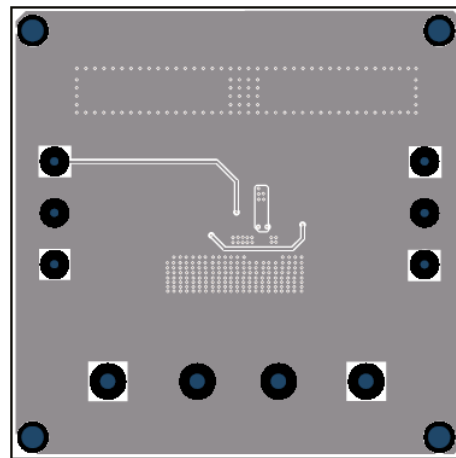

Figure 3—Bottom Layer

QUICK START GUIDE

The output voltage of this board is set to 5V. The board layout accommodates most commonly used components.

1. Preset Power Supply to $1.8V \leq V_{IN} \leq 4.5V$.
2. Turn Power Supply off.
3. Connect Power Supply terminals to:
 - a. Positive (+): VIN
 - b. Negative (-): GND
4. Connect Load to:
 - a. Positive (+): VOUT
 - b. Negative (-): GND
5. Turn Power Supply on after making connections.
6. The MP3415 is enabled on the evaluation board once VIN is applied.
7. The output voltage VOUT can be changed by varying R2. Calculate the new value using the formula:

$$V_{OUT} = V_{FB} \times \left(1 + \frac{R1}{R2}\right)$$

Where $V_{FB} = 0.6V$ and $R1=1M\Omega$.

8. To use the Enable function, apply a digital input to the EN pin. Drive EN higher than 1.2V to turn on EV3415-G-00A or less than 0.4V to turn it off.

NOTICE: The information in this document is subject to change without notice. Please contact MPS for current specifications. Users should warrant and guarantee that third party Intellectual Property rights are not infringed upon when integrating MPS products into any application. MPS will not assume any legal responsibility for any said applications.