

### DESCRIPTION

The EV3022DQ-00A is an evaluation board for the MP3022 that can drive up to 4 backlight WLEDs at up to 30mA each. Backlight brightness can be adjusted with a 5-bit register plus one bit for precise low brightness control.

The MP3022 employs a super efficient inductorless charge pump with 1x, 1.5x, and 2x automatic mode control to achieve high efficiency power conversions.

Monolithic Power System's single wire MPC™ serial data link provides a simple and fast interface used to enable, disable, and set current levels for each LED. In addition, soft-start limits the inrush current during startup and mode switching.

Each output is current limited, providing controlled brightness and short circuit protection. Thermal shutdown protection guards against excessive loads and shorts.

The tiny 3mm x 3mm QFN 16-pin package and small external capacitors deliver the most compact white LED solution available.

### FEATURES

- Backlight: up to 4 WLEDs at 30mA Each
- Single Wire Serial Bus (MPC™ Serial Data Link) Simple, Low Overhead Solution Fast Data Transfer Rate
- Good Current Matching at Low LED Current
- Thermal Shutdown Protection
- Under-Voltage Protection
- Available in a 3mm x 3mm 16-Pin QFN Package
- Low EMI Noise

### APPLICATIONS

- Cell Phone LCD Panel Backlight
- Small LCD Panel Backlight

### ELECTRICAL SPECIFICATIONS

Parameter	Symbol	Value	Units
Input Voltage	V <sub>IN</sub>	2.7 - 5.5	V
Output Voltage	V <sub>OUT</sub>	4.0	V
Output Current	I <sub>OUT</sub>	20	mA

"MPS" and "The Future of Analog IC Technology" are Registered Trademarks of Monolithic Power Systems, Inc.

## EV3022DQ-00A EVALUATION BOARD



(L x W x H) 2.6" x 2.5" x 0.5"  
(6.6cm x 6.4cm x 1.2cm)

Board Number	MPS IC Number
EV3022DQ-00A	MP3022DQ

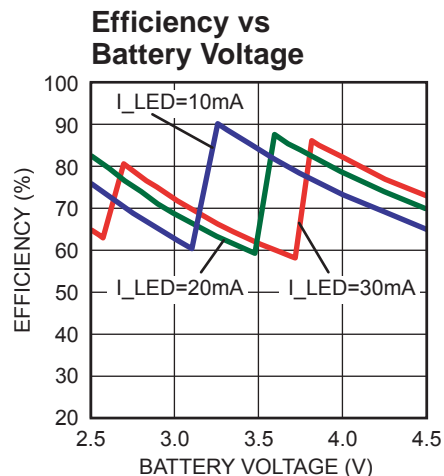

# EVALUATION BOARD SCHEMATIC

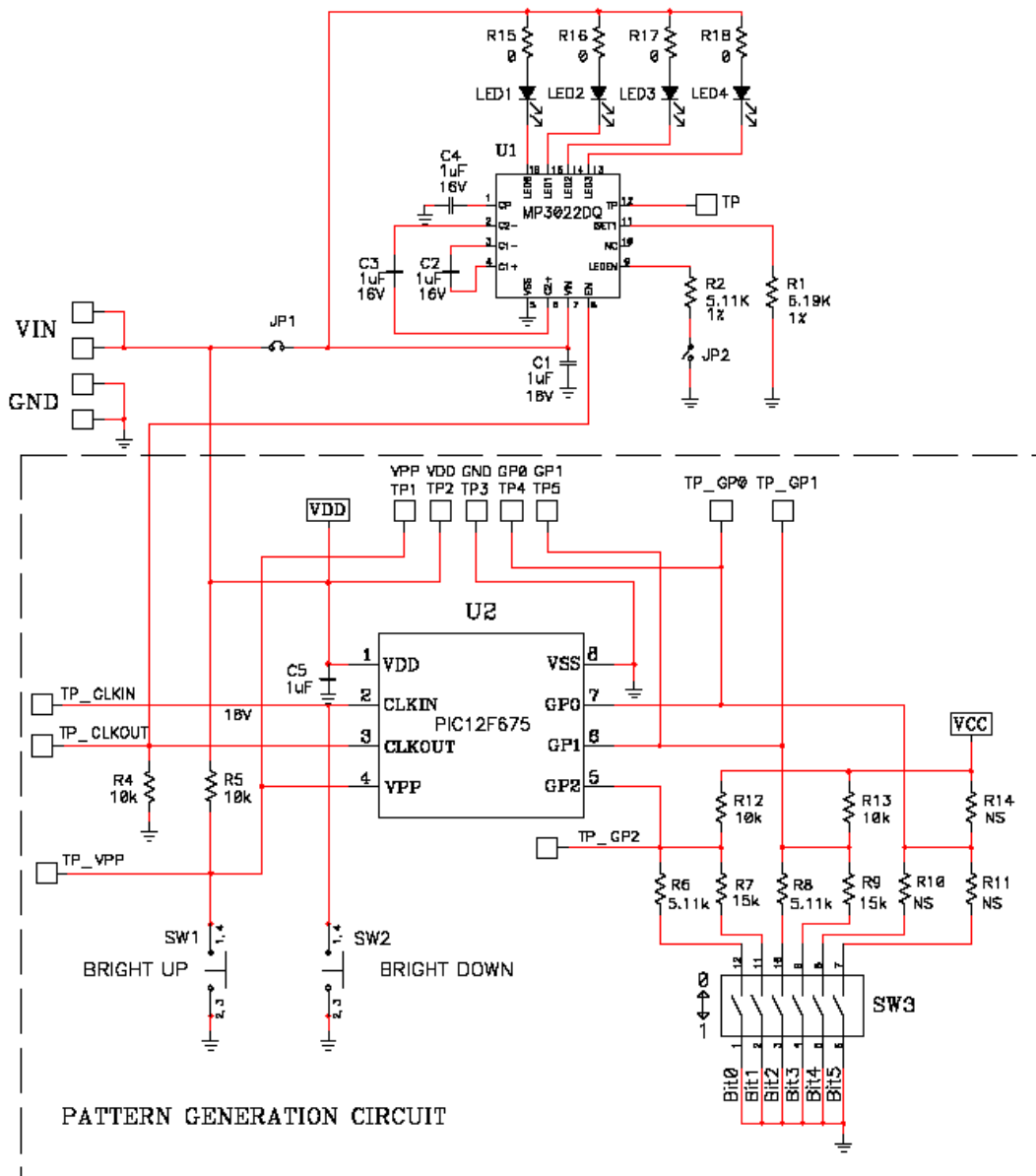

**EV3022DQ-00A BILL OF MATERIALS**

Qty	Ref	Value	Description	Package	Manufacturer	Manufacturer P/N
1	R1	6.19kΩ	Film Res., 1%	SMR0603	Panasonic	ERJ-3EKF6191V
1	R2	5.11kΩ	Film Res., 1%	SMR0603	Panasonic	ERJ-3EKF5111V
4	R15, R16, R17, R18	0Ω	Film Res., 5%	SMR0805	Panasonic	ERJ-6GEY0R00V
4	C1, C2, C3, C4	1μF	16V X7R Ceramic Cap.	SMC0603	muRata	GRM188R71C105KA
	LED1, LED2, LED3, LED4		WLED			
2	JP1,JP2	JUMPER			Digi-Key	PTC02SAAN
1	U1	MPS- 3022DQ	White LED Driver	QFN16 3X3	MPS	MPS-3022DQ

**EV3022DQ-00A PATTERN GENERATION CIRCUIT BILL OF MATERIALS**

Qty	Ref	Value	Description	Package	Manufacturer	Manufacturer P/N
3	R6, R8, R10	5.11KΩ	Film Res, 1%	SMR0603	Panasonic	ERJ-3EKF5111V
5	R4, R5, R12, R13, R14	10KΩ	Film Res, 1%	SMR0603	Panasonic	ERJ-3EKF1002V
3	R7, R9, R11	15KΩ	Film Res, 1%	SMR0603	Panasonic	ERJ-3EKF1502V
1	C5	1μF	16V X7R Ceramic Cap.	SMC0603	muRata	GRM188R71C105KA
2	SW1, SW2	SWITCH	Pushbutton Switch	6.4X6.4x3.1 mm	Panasonic	EVQPHP03T
1	SW3	6 POS SWITCH	Top slide DIP switch	SMT DIP 12	Digi-Key	CKN1290-ND
1	U2	PIC12F 675-I/SN	EEPROM MEMORY	SO-8	Microchip Technology	PIC12F675-I/SN

### PRINTED CIRCUIT BOARD LAYOUT

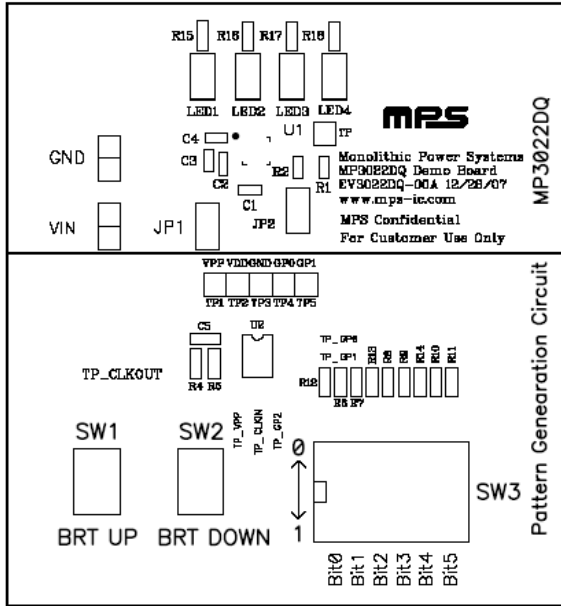

Figure 1—Top Silk Layer

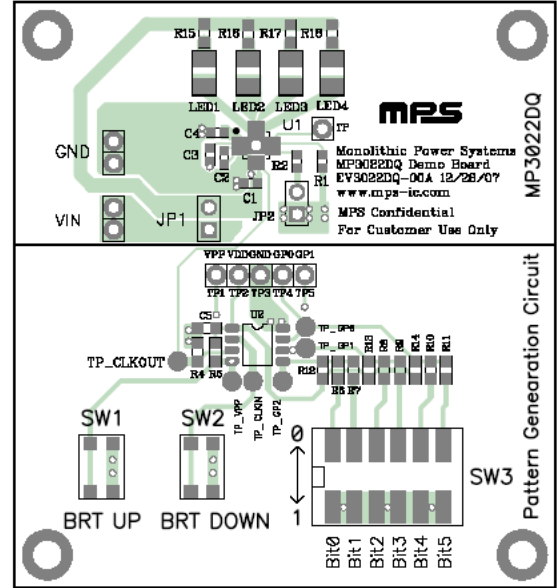

Figure 2—Top Layer

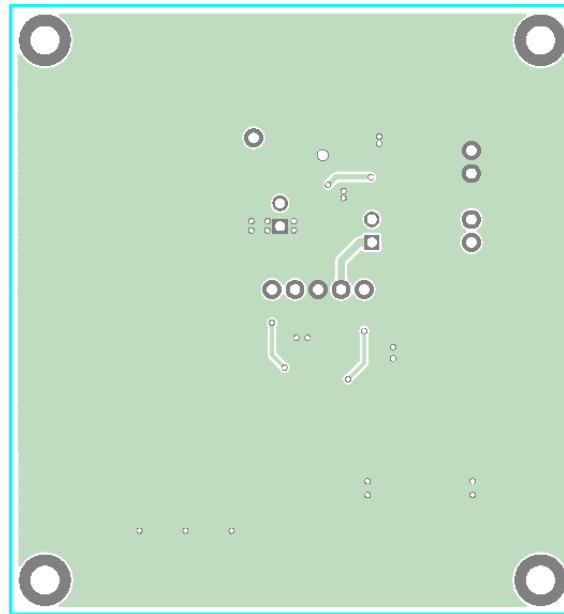
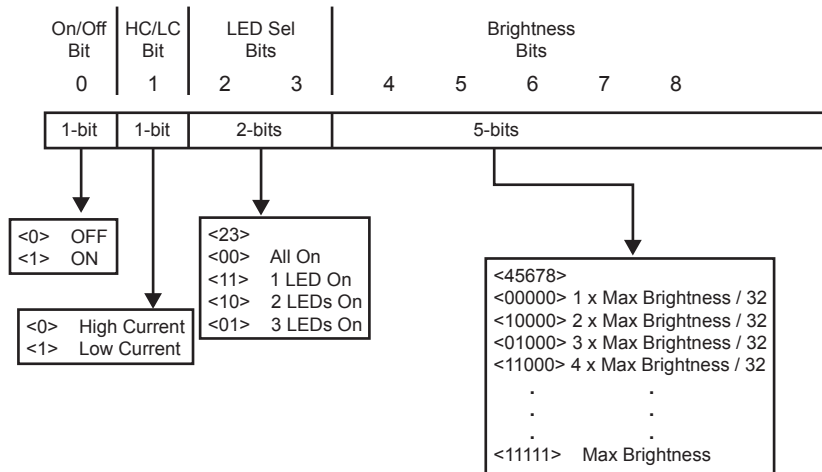

Figure 3—Bottom Layer

## QUICK START GUIDE

1. Solder LED1 – LED4 to the board if they are not populated.
2. Preset the power supply output to between 2.7V –5.5V then turn off the power supply.
3. Connect the positive terminal of the power supply to VIN.
4. Connect the negative terminal of the power supply to GND.
5. Set the number of LEDs by SW3. See Table below and make sure it is in position.



6. Turn on the power supply.
7. Push the “BRT UP” or “BRT DOWN” button to control the brightness of the LEDs. One push represents one level brightness change. Push and hold the button will continuously increase or decrease the brightness.

**NOTICE:** The information in this document is subject to change without notice. Users should warrant and guarantee that third party Intellectual Property rights are not infringed upon when integrating MPS products into any application. MPS will not assume any legal responsibility for any said applications.