



EV24830-S-00C

5V to 90V White LED Driver with Buck Mode and Configurable Frequency Evaluation Board

DESCRIPTION

The EV24830-S-00C is designed to demonstrate the capabilities of the MP24830, a 90V white LED driver that is suitable for step-down applications. It supports a wide input range with excellent load and line regulation. Its configurable current limit provides customized applications with a wide power range. Current mode operation provides fast transient response and eases loop stabilization. Protections include thermal shutdown, cycle-by-cycle over-current protection (OCP), open string protection, and output short-circuit protection (SCP).

The MP24830 incorporates both DC and PWM dimming onto a single control pin. The separate input reference ground pin allows for direct enabling and/or dimming control for positive to negative power conversion. The MP24830 is available in an SOIC-14 package.

ELECTRICAL SPECIFICATIONS

Parameter	Symbol	Value	Units
Input voltage	V_{IN}	$V_{OUT} + 2$ to 90	V
Enable voltage	V_{EN}	5	V
LED current	I_{LED}	1	A
Switching frequency	f_{SW}	200	kHz
Output voltage protection	V_{OVP}	28	V

FEATURES

- Configurable Maximum Output Current
- Buck Mode Functionality
- Wide 5V to 90V Operating Input Range
- Adjustable Switching Frequency
- Analog and PWM Dimming
- 0.2V Reference Voltage
- 5 μ A Shutdown Mode
- No Minimum LED Required
- Stable with Low-ESR Output Ceramic Capacitors
- Cycle-by-Cycle Over-Current Protection (OCP)
- Thermal Shutdown Protection
- Open String Protection
- Output Short-Circuit Protection (SCP)
- Available in an SOIC-14 Package

APPLICATIONS

- General LED Illuminations
- Automotive LED Lighting
- TV Backlighting Systems
- LCD Backlight Panels
- Handheld Computers

All MPS parts are lead-free, halogen-free, and adhere to the RoHS directive. For MPS green status, please visit the MPS website under Quality Assurance. "MPS", the MPS logo, and "Simple, Easy Solutions" are trademarks of Monolithic Power Systems, Inc. or its subsidiaries.

EV24830-S-00C EVALUATION BOARD

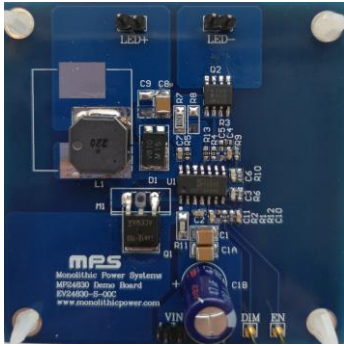

(LxWxH) 6.4cmx6.4cmx1.3cm

Board Number	MPS IC Number
EV24830-S-00C	MP24830

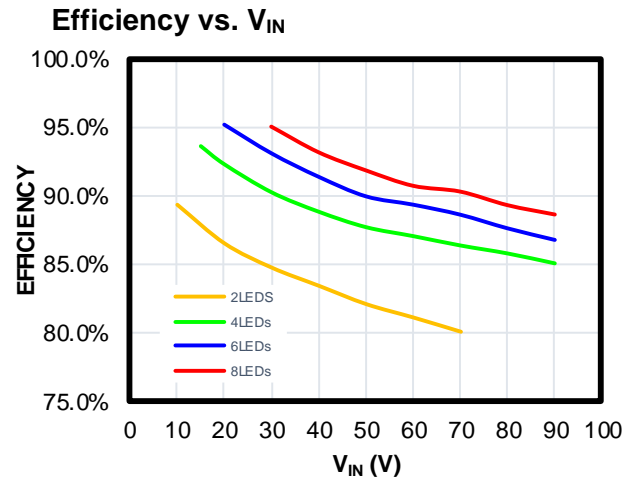

QUICK START GUIDE

1. Connect the LED string between LED+ (anode of the LED string) and LED- (cathode of the LED string). The LED string voltage should be below 28V (7 LED string voltages equal about 25V) to avoid triggering output over-voltage protection (OVP).
2. Set the VIN power supply voltage ($V_{OUT} + 2V \leq V_{IN} \leq 90V$), then connect the input between the VIN and INGND terminals on the evaluation board.
3. Set a second power supply (about 5V) to act as the the EN input supply for the evaluation board.
4. Turn all the power supplies off.
5. Turn the input voltage power supply on.
6. Turn the EN power supply on. The LED strings should light up.
7. Use R6 to set the switching frequency to about 200kHz.
8. To use the dimming function on the DIM connector, use a function generator to set the PWM signal amplitude to 5V. Then set the frequency between 100Hz and 20kHz for PWM dimming. For analog dimming, adjust the power supply from 0.7V to 2V

EVALUATION BOARD SCHEMATIC

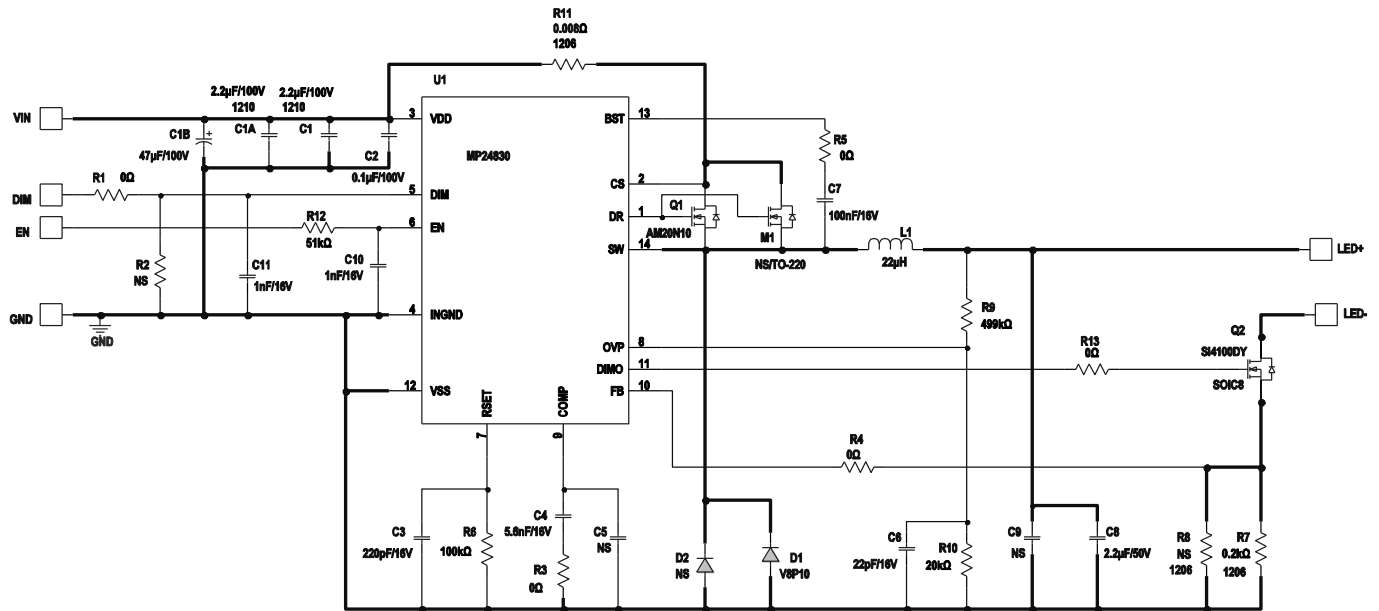

Figure 1: Evaluation Board Schematic

EV24830-S-00C BILL OF MATERIALS

Qty	Ref	Value	Description	Package	Manufacturer	Manufacturer P/N
3	C1, C1A, C8	2.2 μ F	Ceramic capacitor, 100V, 10%, X7R	1210	Murata	GRM32ER72A225K
1	C1B	47 μ F	Aluminum capacitor, 100V, 10%,	8mmx12mm x3.5mm	Panasonic	ECA-2AM470
1	C2	0.1 μ F	Ceramic capacitor, 100V, 10%, X7R	0603	Murata	GRM188R72A104KA35D
1	C3	220pF	Ceramic capacitor, 50V, 10%, X7R	0603	Murata	GRM188R71H221KA01D
1	C4	5.6nF	Ceramic capacitor, 50V, 10%, X7R	0603	Murata	GRM188R71H562KA01D
	C5, C9	NS	NS	NS	NS	NS
1	C6	22pF	Ceramic capacitor, 50V, 5%, C0G	0603	Murata	GRM1885C1H220JA01D
1	C7	0.1 μ F	Ceramic capacitor, 50V, 10%, X7R	0603	Murata	GRM188R71E104KA01D
2	C10, C11	1nF	Ceramic capacitor, 50V, 10%, X7R	0603	Murata	GRM188R71H102KA01D
1	D1	8A	Schottky diode, 100V, 8A	TO-277A	Vishay	V8P10
	D2	NS	NS	TO-277A	NS	NS
1	L1	22 μ H	Inductor, R _{DC} = 68m Ω , I _{SAT} = 4.2A	SMD	Murata	1274AS-H-220M=P3
5	R1, R3, R4, R5, R13	0	Film resistor, 5%	0603	Yageo	RC0603JR-070RL
	R2	NS	Film resistor, 5%	0603	Yageo	
1	R6	100k Ω	Film resistor, 1%	0603	Yageo	9C06031A1003FKHFT
1	R7	200m Ω	Film resistor, 0.5W, 1%	1206	Cyntec	RLT1632-4-R200-FNH
	R8	NS	NS	1206	NS	NS
1	R9	499k Ω	Film resistor, 1%	0603	Yageo	9C06031A4993FKHFT
1	R10	20k Ω	Film resistor, 1%	0603	Yageo	9C06031A2002FKHFT
1	R11	8m Ω	Film resistor, 0.5W, 1%	1206	Cyntec	RL1632H-R008-FNH
1	R12	51k Ω	Film resistor, 5%	0603	Yageo	9C06031A5102FKHFT
1	Q1	N-channel MOSFET	100V MOSFET	TO-252	Analog Power	AM20N10-160D
1	Q2	N-channel MOSFET	100V MOSFET	SO-8	Vishay	Si4100DY
	M1	NS	MOSFET	TO-220	NS	NS
1	U1	MP24830	Power LED driver	SOIC-14	MPS	MP24830HS-LF-Z

EVB TEST RESULTS

Performance waveforms are tested on the evaluation board. $V_{IN} = 10V$ to $90V$, $I_{OUT} = 1A$, $L = 22\mu H$, $T_A = 25^\circ C$, unless otherwise noted.

Efficiency vs. V_{IN}

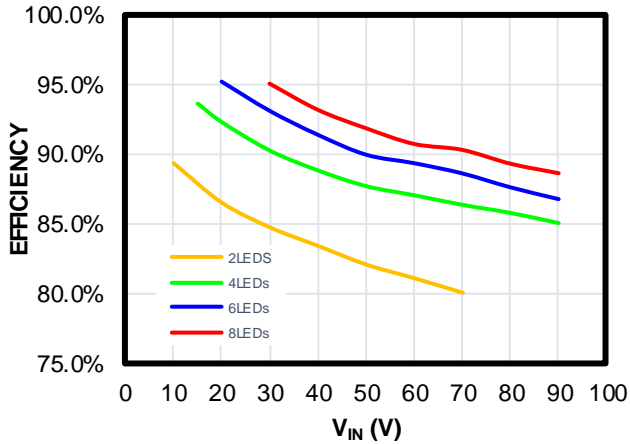

Efficiency vs. LED Voltage

$V_{IN} = 50V$

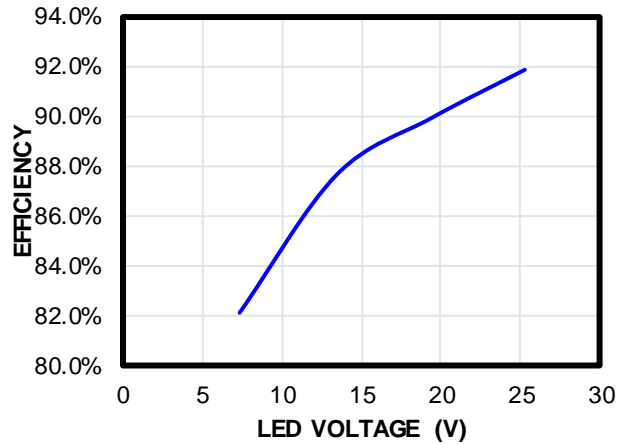

Line Regulation

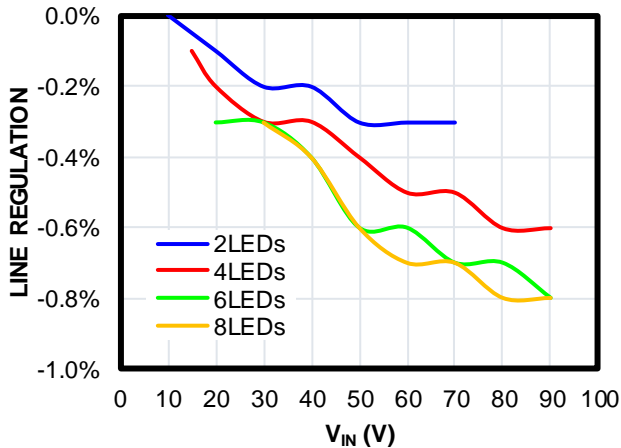

PWM Dimming Curve

$V_{IN} = 25V$, 3 LEDs, $f_{PWM} = 200Hz$

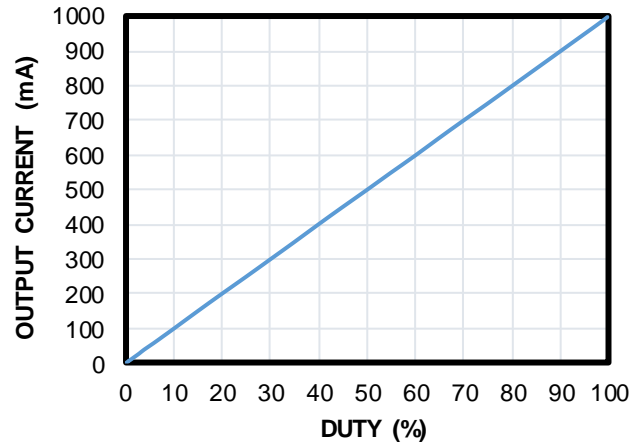

Analog Dimming Curve

$V_{IN} = 25V$, 3 LEDs

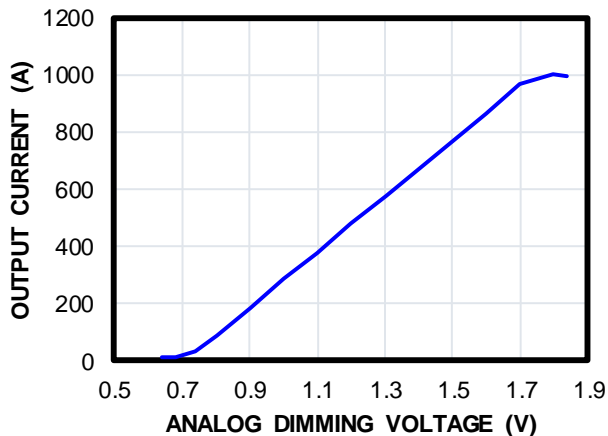

EVB TEST RESULTS

Performance waveforms are tested on the evaluation board. $V_{IN} = 10V$ to $90V$, $I_{OUT} = 1A$, $L = 22\mu H$, $T_A = 25^\circ C$, unless otherwise noted.

Steady State

$V_{IN} = 25V$, 3 LEDs, $I_{OUT} = 1A$

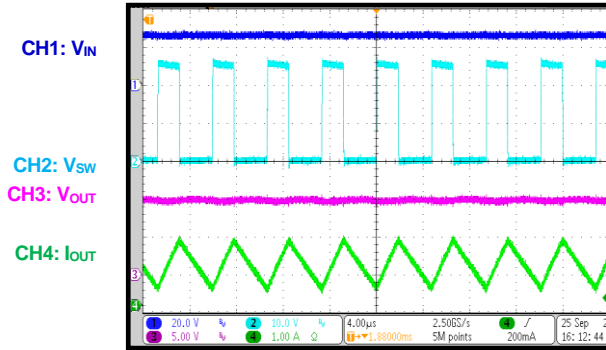

PWM Dimming

$V_{IN} = 25V$, 3LEDs, $I_{OUT} = 1A$, $f_{PWM} = 200Hz$

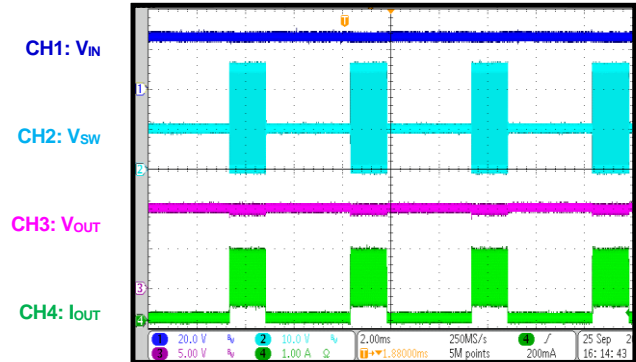

LED-to-GND Short

$V_{IN} = 25V$, 3 LEDs, $I_{OUT} = 1A$

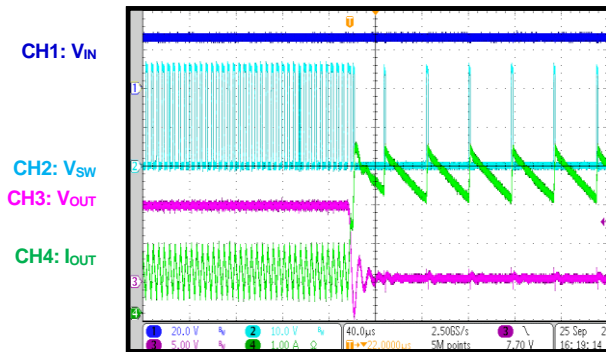

LED Short Output

$V_{IN} = 25V$, 3 LEDs, $I_{OUT} = 1A$

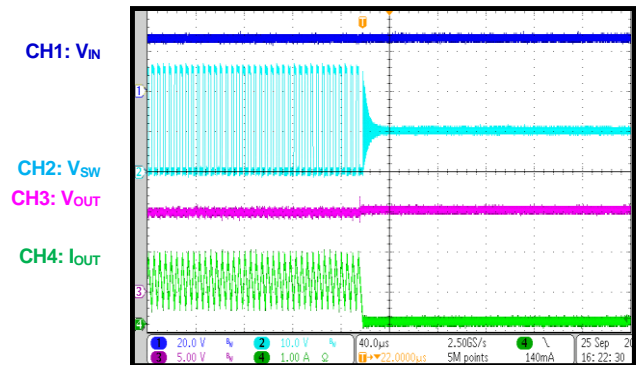

PCB LAYOUT

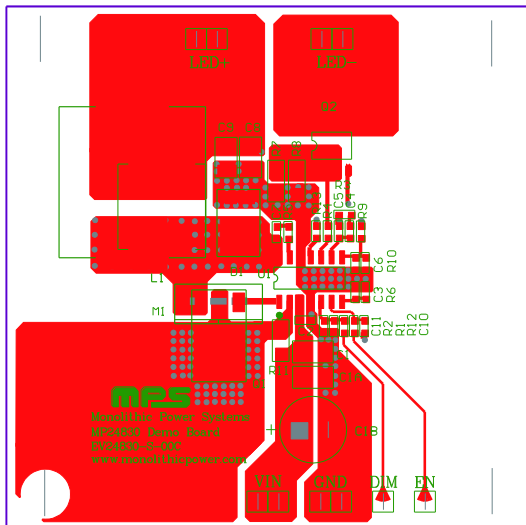

Figure 2: Top Layer

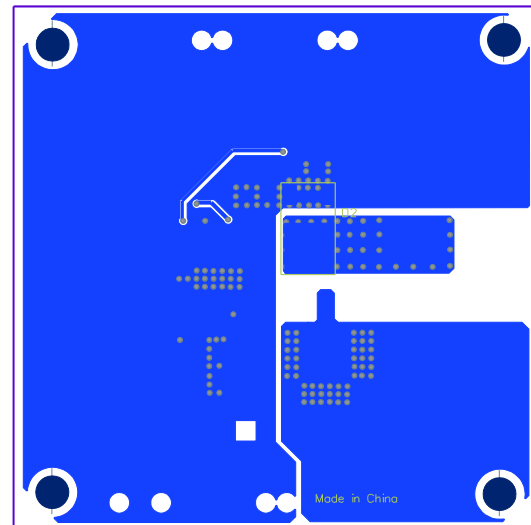

Figure 3: Bottom Layer



Revision History

Revision #	Revision Date	Description	Pages Updated
1.0	12/1/2020	Initial Release	-

Notice: The information in this document is subject to change without notice. Please contact MPS for current specifications. Users should warrant and guarantee that third-party Intellectual Property rights are not infringed upon when integrating MPS products into any application. MPS will not assume any legal responsibility for any said applications.