

DESCRIPTION

The EV2276-D-00A is an evaluation board for the MP2276, a high efficiency, monolithic, synchronous step-down converter.

The EV board can deliver 8A continuous load current over a wide operating input range. High efficiency can be achieved over a wide output current load range.

The MP2276 adopts internally compensated constant-on-time (COT) control mode that provides fast transient response and eases loop stabilization.

This EV board can be turned on or off via a remote ON/OFF input (EN) that is referenced to ground. This input is compatible with popular logic devices.

ELECTRICAL SPECIFICATION

Parameter	Symbol	Value	Units
Input Voltage	V _{IN}	4-16	V
Output Voltage	V _{OUT}	1	V
Output Current	I _{OUT}	8	A

FEATURES

- Wide 4V to 16V input Voltage Range
- 8A Continuous Output Current
- 24mΩ/10mΩ Low R_{DS(ON)} Integrated Power MOSFETs
- Adaptive COT for Ultrafast Transient Response
- Stable with Zero-ESR Output Capacitor
- Programmable Current Limit
- Selectable Forced CCM or Pulse-Skip Operation at Light Load
- Excellent Load Regulation
- Programmable Soft Start Time from 1.7ms and up
- Pre-Bias Start up
- Selectable 600kHz, 1100kHz or 2000kHz Switching Frequency
- Hiccup OCP Protection
- Auto Retry OVP Protection and Thermal Shutdown
- Output Adjustable from 0.8V
- Available in QFN-14 (2x3mm) package

APPLICATIONS

- Digital Set Top Boxes
- Flat panel TV and Monitors
- Distributed Power Systems

All MPS parts are lead-free, halogen free, and adhere to the RoHS directive. For MPS green status, please visit MPS website under Quality Assurance.
 "MPS" and "The Future of Analog IC Technology" are Registered Trademarks of Monolithic Power Systems, Inc.

EV2276-D-00A EVALUATION BOARD



(L x W) 78cm x 81cm

Board Number	MPS IC Number
EV2276-D-00A	MP2276GD

Efficiency vs. Output Current
 V_{OUT}=1V, L=1μH (DCR=4.6mΩ)

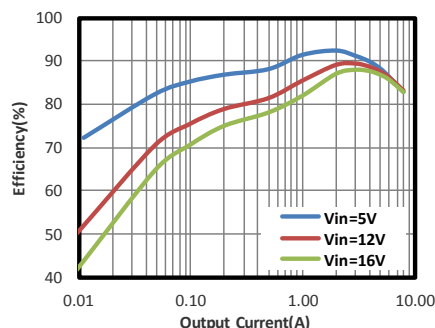

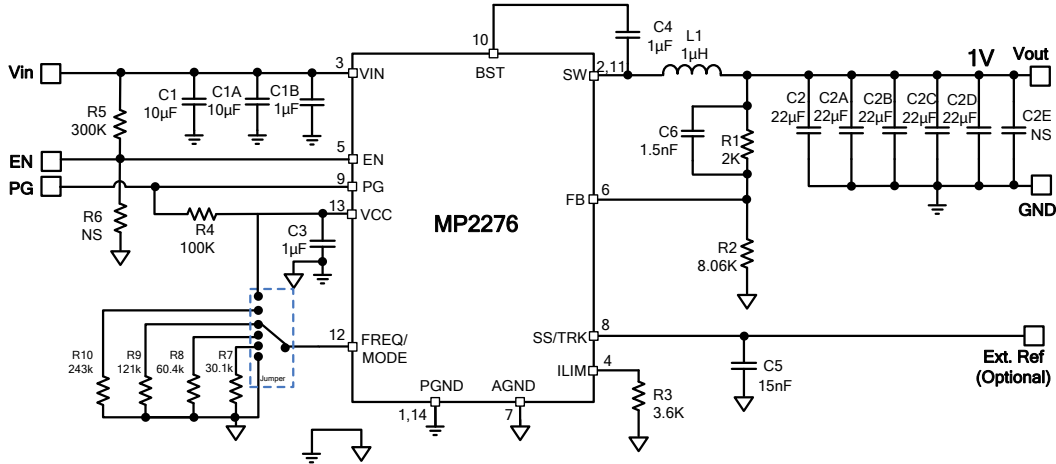
EVALUATION BOARD SCHEMATIC

EV2276-D-00A BILL OF MATERIALS

Qty	Ref	Value	Description	Package	Manufacturer	Part Number
2	C1, C1A	10µF	Ceramic Cap,25V,X5R	1206	Murata	GRM31CR61E106KA12L
3	C1B, C3, C4	1µF	Ceramic Cap,25V,X7R	0603	Murata	GRM188R71E105KA12D
5	C2, C2A, C2B, C2C, C2D	22µF	Ceramic Cap, 16V, X5R	0805	Murata	GRM219R61C226ME15L
0	C2E	NS				
1	C5	15nF	Ceramic Cap,50V,X7R	0603	Murata	GRM188R71H153KA01D
1	C6	1.5nF	Ceramic Cap,50V,COG	0603	Murata	GRM1885C1H152JA01D
1	R1	2k	Film Res., 1%	0603	Yageo	RC0603FR-072KL
1	R2	8.06k	Film Res., 1%	0603	Yageo	RC0603FR-078K06L
1	R3	3.6k	Film Res., 1%	0603	Yageo	RC0603FR-073K6L
1	R4	100k	Film Res., 1%	0603	Yageo	RC0603FR-07100KL
1	R5	300k	Film Res., 1%	0603	Yageo	RC0603FR-07300KL
0	R6	NS				
1	R7	30.1k	Film Res., 1%	0603	Yageo	RC0603FR-0730K1L
1	R8	60.4k	Film Res., 1%	0603	Yageo	RC0603FR-0760K4L
1	R9	121k	Film Res., 1%	0603	Yageo	RC0603FR-07121KL
1	R10	243k	Film Res., 1%	0603	Yageo	RC0603FR-07243KL
1	L1	1µH	DCR 4.6mΩ,Isat 19A	SMD	Würth	744311100
1	U1	MP2276GD	16V/8A Step Down Convert	QFN14-2X3mm	MPS	MP2276GD

EVB TEST RESULTS

Performance waveforms are tested on the EV2276-D-00A evaluation board.

$V_{IN}=12V$, $V_{OUT}=1V$, $L=1\mu H$, $F_{SW}=600kHz$, pulse skip mode. $T_A = +25^\circ C$, unless otherwise noted.

Load Regulation

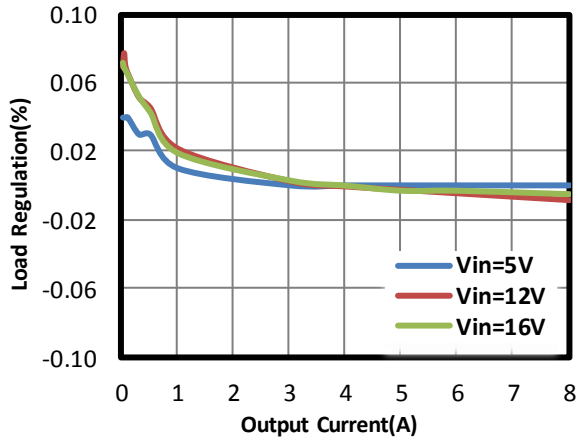

Line Regulation

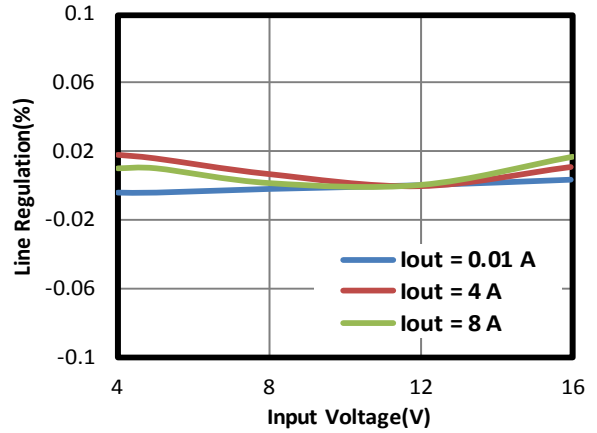

Case Temperature Rise vs. Output Current

4 Layers PCB, size is 7.75cmx8.13cm.

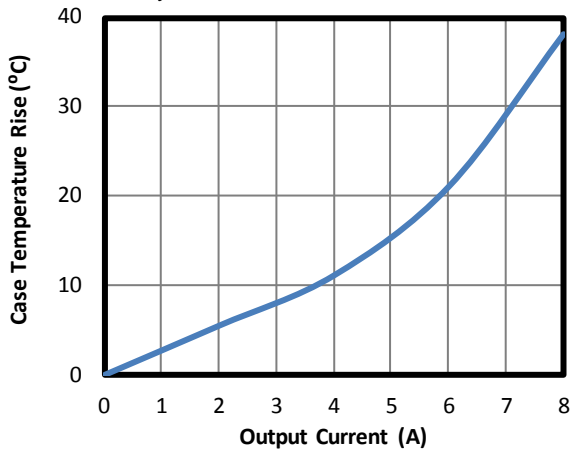

EVB TEST RESULTS *(continued)*

Performance waveforms are tested on the EV2276-D-00A evaluation board.

$V_{IN}=12V$, $V_{OUT}=1V$, $L=1\mu H$, $F_{SW}=600kHz$, pulse skip mode. $T_A = +25^\circ C$, unless otherwise noted.

Start-Up through Input Voltage
 $I_{OUT}=0A$

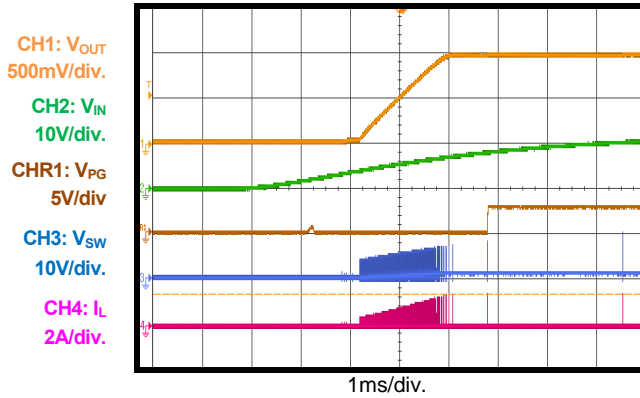

Shutdown through Input Voltage
 $I_{OUT}=0A$

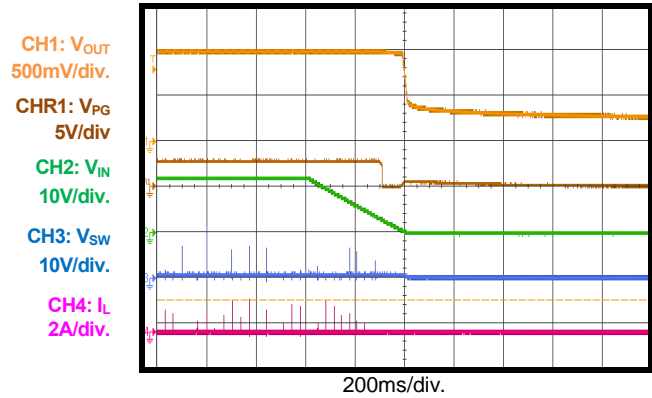

Start-Up through Input Voltage
 $I_{OUT}=8A$

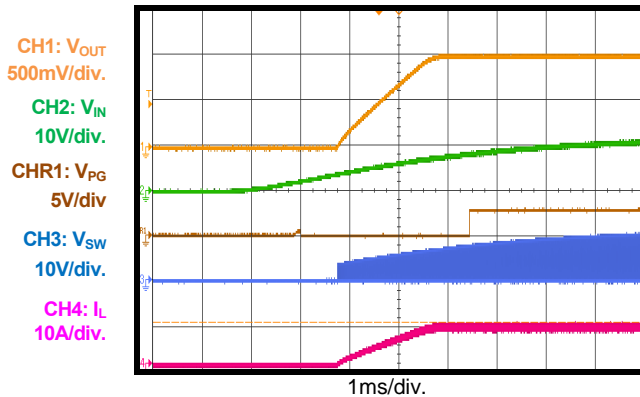

Shutdown through Input Voltage
 $I_{OUT}=8A$

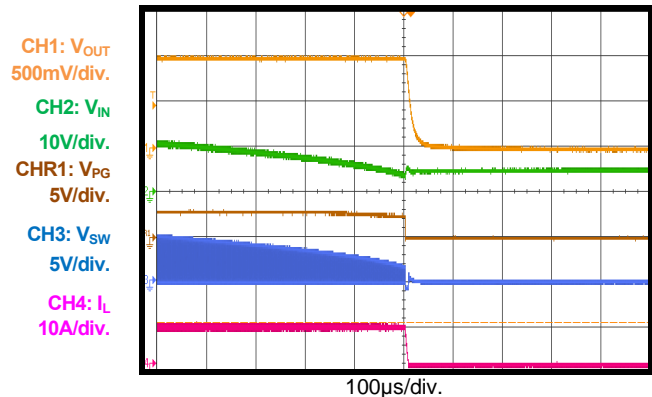

Start-Up through Enable
 $I_{OUT}=0A$

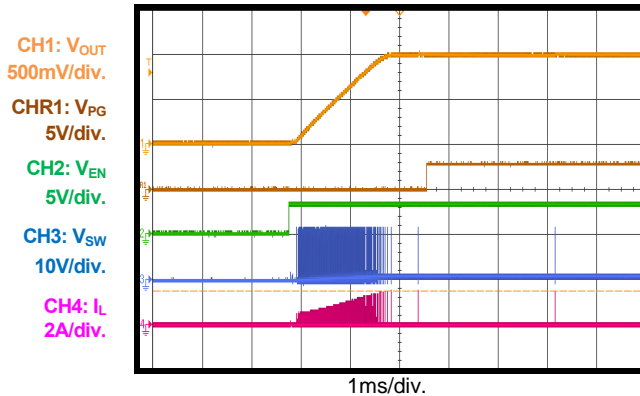

Shutdown through Enable
 $I_{OUT}=0A$

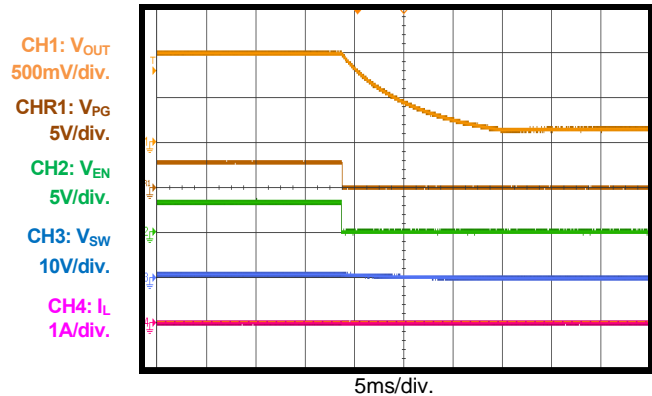

EVB TEST RESULTS *(continued)*

Performance waveforms are tested on the EV2276-D-00A evaluation board.

$V_{IN}=12V$, $V_{OUT}=1V$, $L=1\mu H$, $F_{SW}=600kHz$, pulse skip mode. $T_A = +25^{\circ}C$, unless otherwise noted.

Start-Up through Enable

$I_{OUT}=8A$

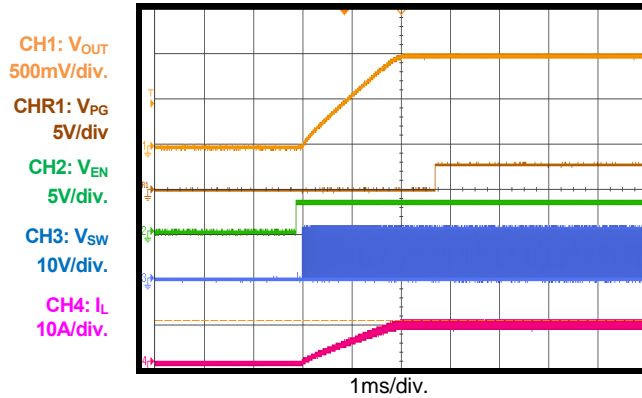

Shutdown through Enable

$I_{OUT}=8A$

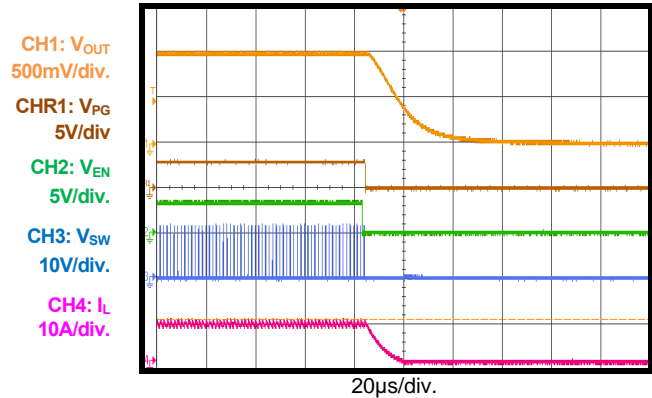

Input / Output Ripple

$I_{OUT}=0A$

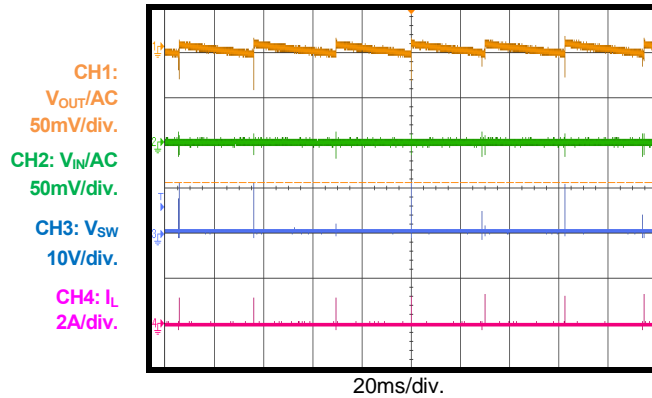

Input / Output Ripple

$I_{OUT}=8A$

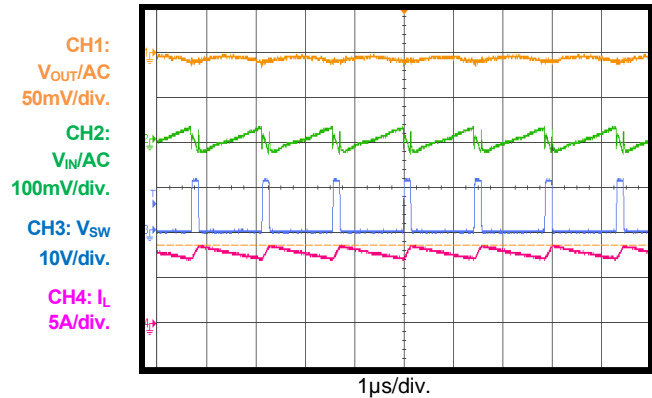

Transient Response

$I_{OUT}=4A-8A$, Slew Rate= $2.5A/\mu s$ by Eload

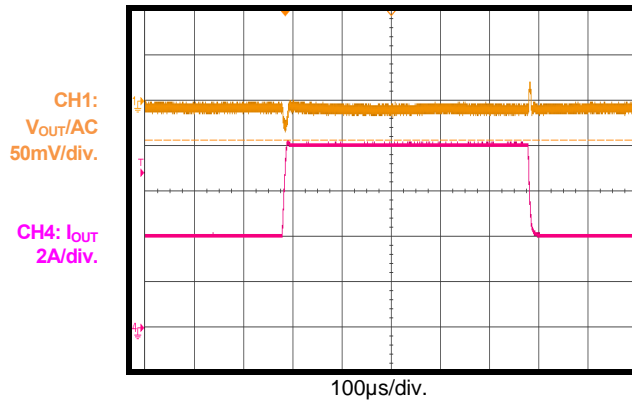

Short-Circuit Entry

$I_{OUT}=0A$

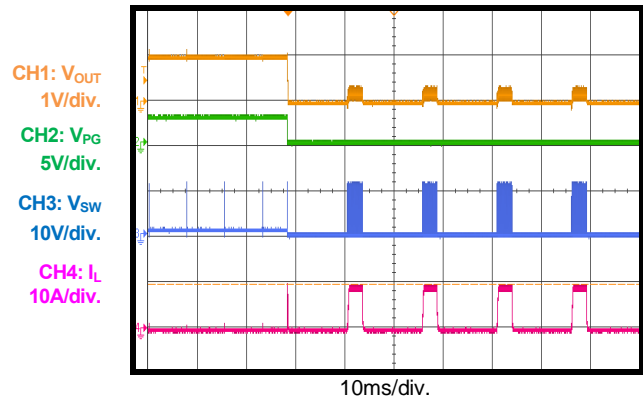

EVB TEST RESULTS *(continued)*

Performance waveforms are tested on the EV2276-D-00A evaluation board.

$V_{IN}=12V$, $V_{OUT}=1V$, $L=1\mu H$, $F_{SW}=600kHz$, pulse skip mode. $T_A = +25^{\circ}C$, unless otherwise noted.

Short Circuit Recovery

$I_{OUT}=0A$

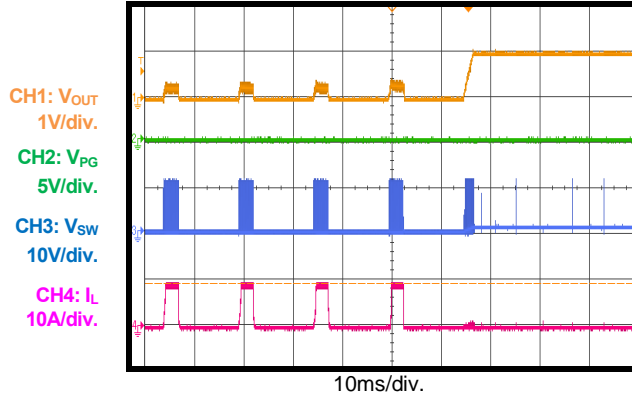

PRINTED CIRCUIT BOARD LAYOUT

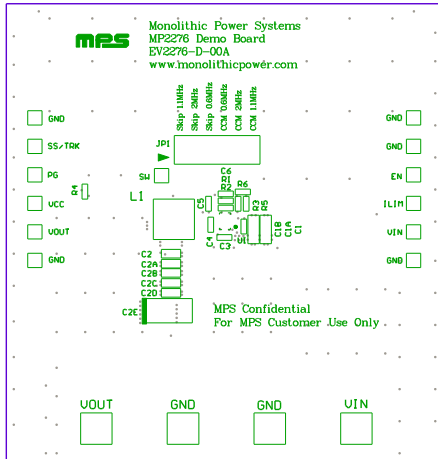

Figure 1—Top Silk Layer

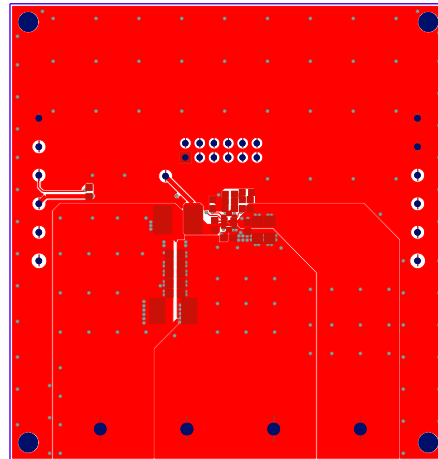

Figure 2—Top Layer

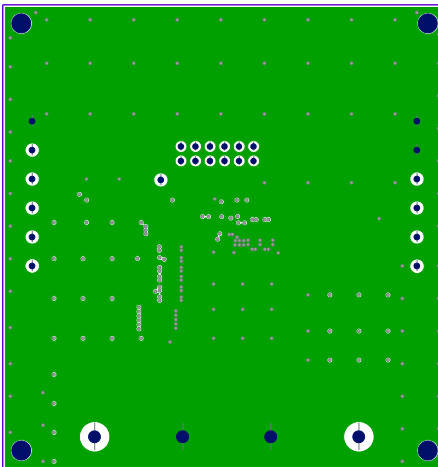

Figure 3—Inner Layer 1

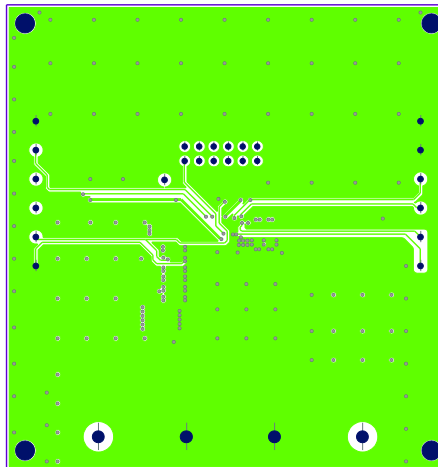

Figure 4— Inner Layer 2

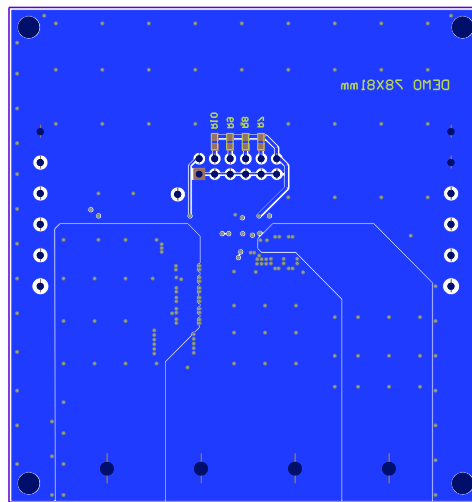

Figure 5—Bottom Layer and Bottom Silk Layer

QUICK START GUIDE

1. Connect the positive and negative terminals of the load to the VOUT and GND pins, respectively.
2. Preset the power supply output voltage between 4V and 16V, and then turn off the power supply.
3. Connect the positive and negative terminals of the power supply output to the VIN and GND pins, respectively. Make sure the power supply has current limit high enough to supply the power.
4. Turn the power supply on. The EV2276-D-00A will automatically startup.
5. For low VIN and heavy load case, choose larger input cap to improve stability.
6. To use the Enable function, apply a digital input to the EN pin. Drive EN higher than 1.27V to turn on the regulator or less than 0.93V to turn it off.
7. Use R1 and R2 to set the output voltage with $V_{FB} = 0.8 \text{ V}$. Follow the Application Information section in the device datasheet to select the proper values of R1, R2, inductor and output capacitor values when output voltage is changed.
8. The JP1 jumper can be used to select the operating frequency (600kHz, 1100kHz or 2000kHz) and light load operation mode (Pulse Skip or CCM).

NOTICE: The information in this document is subject to change without notice. Please contact MPS for current specifications. Users should warrant and guarantee that third party Intellectual Property rights are not infringed upon when integrating MPS products into any application. MPS will not assume any legal responsibility for any said applications.