

## DESCRIPTION

The MP155 is a primary-side regulator that provides accurate constant voltage regulation without the opto-coupler, and supports buck, buck-boost, and flyback topologies. An integrated 500V MOSFET simplifies the structure and reduces costs. These features make it a competitive candidate for off-line low-power applications, such as home appliances and standby power.

The MP155 is a green-mode-operation regulator. Both the peak current and the switching frequency decrease as the load decreases. As a result, it offers excellent efficiency performance at light load, thus improving the overall average efficiency.

The MP155 features various protections such as thermal shutdown (TSD), VCC under-voltage lockout (UVLO), overload protection (OLP), short-circuit protection (SCP), and open loop protection.

The MP155 is available in the TSOT23-5 package.

## FEATURES

- Primary-side constant voltage (CV) control, supporting buck, buck-boost and flyback topologies
- Integrated 500V/20Ω MOSFET
- < 100mW No-load power consumption
- Up to 3W output power
- Maximum DCM output current of 130mA
- Maximum CCM output current of 220mA
- Low VCC operating current
- Frequency foldback
- Maximum frequency limit
- Peak current compression
- Internal high-voltage current source
- Internal 350ns leading-edge blanking
- Thermal shutdown (auto restart)
- VCC under-voltage lockout with hysteresis (UVLO)
- Timer-based overload protection.
- Short circuit protection
- Open loop protection

## APPLICATIONS

- Home Appliance, white goods and consumer electronics
- Industrial Controls
- Standby Power

All MPS parts are lead-free and adhere to the RoHS directive. For MPS green status, please visit MPS website under Quality Assurance.

"MPS" and "The Future of Analog IC Technology", are Registered Trademarks of Monolithic Power Systems, Inc..

### EV155-J-00A EVALUATION BOARD



( L x W x H ) 3.4cm x 2.2cm x 1.6cm

Board Number	MPS IC Number
EV155-J-00A	MP155GJ

### EVALUATION BOARD SCHEMATIC

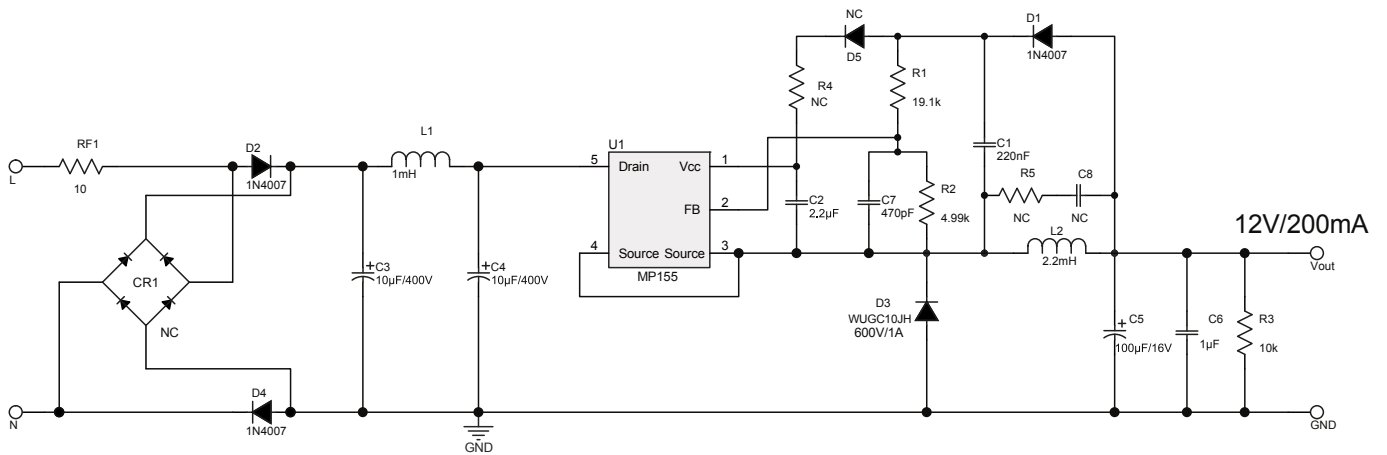

**EV155-J-00A BILL OF MATERIALS**

Qty	Ref	Value	Description	Package	Manufacture	Part Number
1	C1	220nF	Ceramic Capacitor; 16V;X7R;0603;	0603	muRata	GRM188R71C224KA01
1	C2	2.2μF	Ceramic Capacitor; 10V;X7R;0603	0603	muRata	GRM188R71A225KE15D
2	C3, C4	10μF/400V	Capacitor;400V;20%	DIP	Any	Any
1	C5	100μF/16V	Electrolytic Capacitor; 16V;Electrolytic;DIP	DIP	Jianghai	CD11C-16V100
1	C6	1μF	Ceramic Capacitor; 50V;X7R;0805;	0805	muRata	GRM21BR71H105KA12L
1	C7	470pF	Ceramic Capacitor;50V;COG	0603	TDK	C1608COG1H471J
3	D1, D2, D4	1N4007	Diode;1000V;1A	DO-41	Diodes	1N4007
1	D3	WUGC10JH	Diode;600V;1A	SMA	ZOWIE	WUGC10JH
1	L1	1mH	Inductor;1mH;6; 250mA	DIP	Wurth	7447462102
1	L2	2.2mH	Inductor;2.2mH;4.73; 300mA	DIP	Wurth	7447720222
1	R1	19.1k	Film Resistor;1%	0603	Yageo	RC0603FR-0719K1L
1	R2	4.99k	Film Resistor;1%;	0603	Yageo	RC0603FR-074K99L
1	R3	10k	Resistor;1%	0603	Yageo	RC0603FR-0710KL
1	RF1	10	Fuse Resistor;5%;1W	DIP	Any	10 Ohm/1W
1	U1	MP155GJ	Buck regulator	TSOT23-5	MPS	MP155GJ

## EVB TEST RESULTS

Performance waveforms are tested on the evaluation board.

$V_{IN} = 85\text{-}265\text{Vac}$ ,  $V_{OUT} = 12\text{V}$ ,  $I_{OUT} = 200\text{mA}$ ,  $T_A = 25^\circ\text{C}$ , unless otherwise noted.

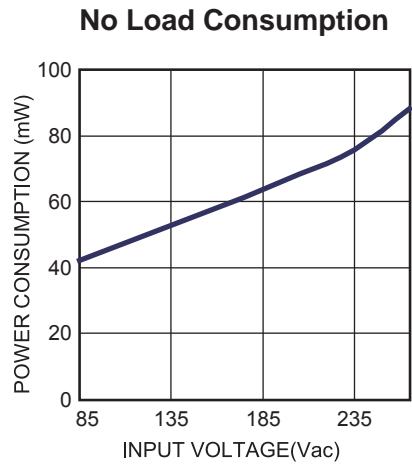
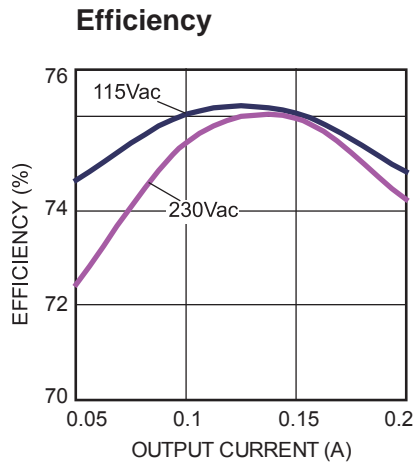

**Normal Operation**

$V_{IN} = 115\text{Vac}$ , Full Load

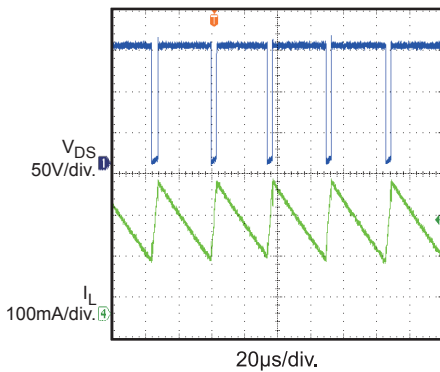

**Normal Operation**

$V_{IN} = 230\text{Vac}$ , Full Load

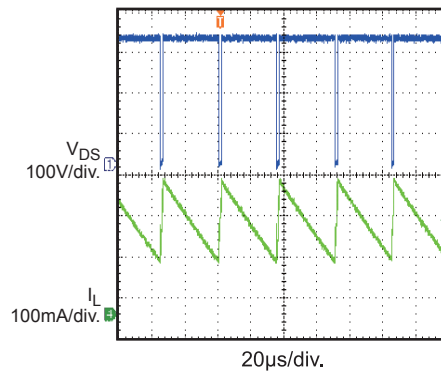

**Output Ripple**

$V_{IN} = 115\text{Vac}$ , No Load

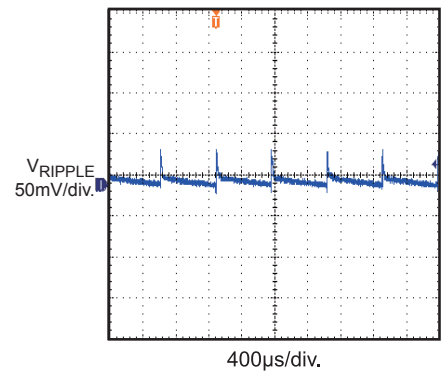

**Output Ripple**

$V_{IN} = 115\text{Vac}$ , Full Load

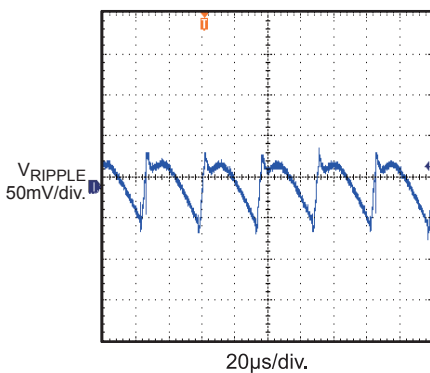

**Output Ripple**

$V_{IN} = 230\text{Vac}$ , No Load

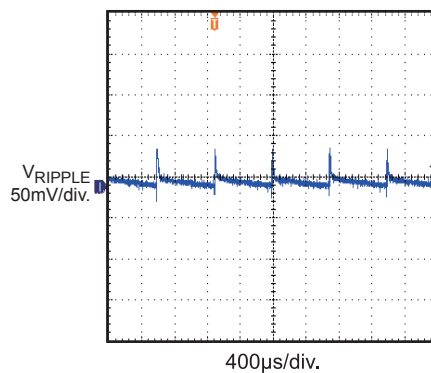

**Output Ripple**

$V_{IN} = 230\text{Vac}$ , Full Load

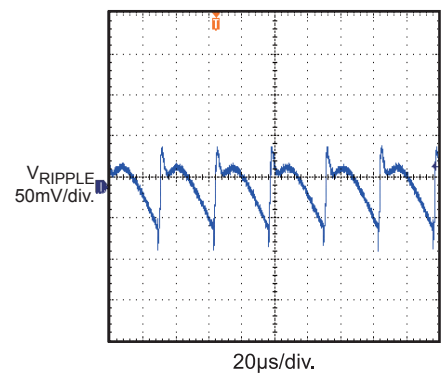

**EVB TEST RESULTS (continued)**

Performance waveforms are tested on the evaluation board.

 $V_{IN} = 85\text{-}265\text{Vac}$ ,  $V_{OUT} = 12\text{V}$ ,  $I_{OUT} = 200\text{mA}$ ,  $T_A = 25^\circ\text{C}$ , unless otherwise noted.

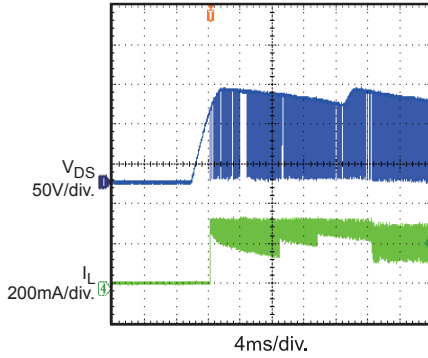
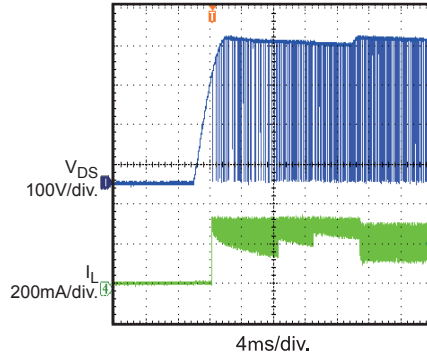
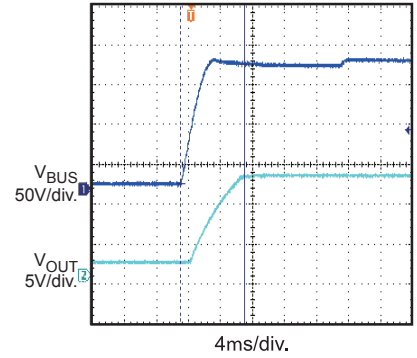
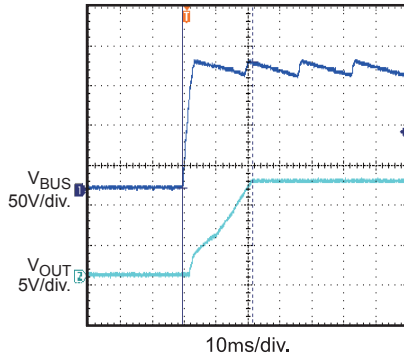
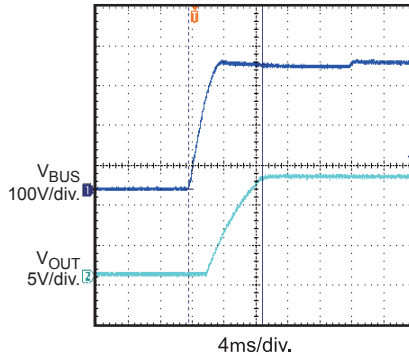
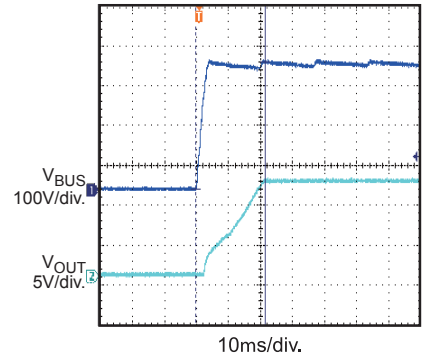
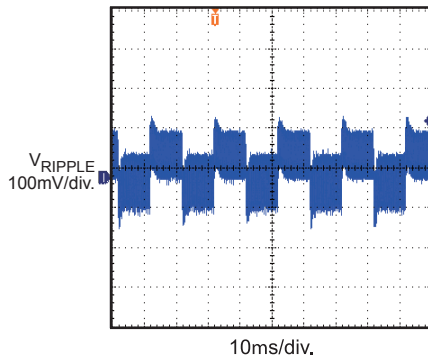
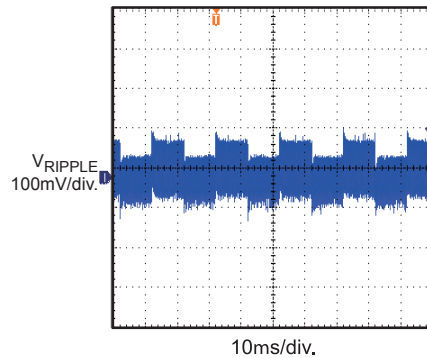
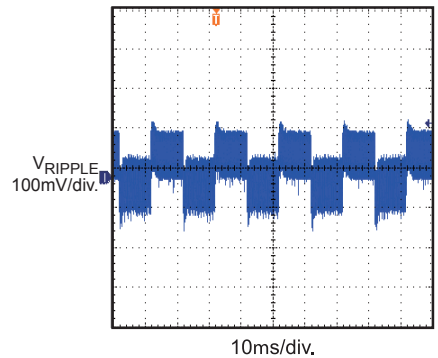
**Soft Start**
 $V_{IN} = 85\text{Vac}$ 

**Soft Start**
 $V_{IN} = 265\text{Vac}$ 

**Turn-on Delay**
 $V_{IN} = 115\text{Vac}$ , No Load

**Turn-on Delay**
 $V_{IN} = 115\text{Vac}$ , Full Load

**Turn-on Delay**
 $V_{IN} = 230\text{Vac}$ , No Load

**Turn-on Delay**
 $V_{IN} = 230\text{Vac}$ , Full Load

**Load Transient**
 $V_{IN} = 115\text{Vac}$ ,  
25% Load to 50% Load

**Load Transient**
 $V_{IN} = 115\text{Vac}$ ,  
50% Load to 75% Load

**Load Transient**
 $V_{IN} = 230\text{Vac}$ ,  
25% Load to 50% Load

**EVB TEST RESULTS (continued)**

Performance waveforms are tested on the evaluation board.

$V_{IN} = 85\text{-}265\text{VAC}$ ,  $V_{OUT} = 12\text{V}$ ,  $I_{OUT} = 200\text{mA}$ ,  $T_A = 25^\circ\text{C}$ , unless otherwise noted.

**Load Transient**

$V_{IN} = 230\text{Vac}$ ,  
50% Load to 75% Load

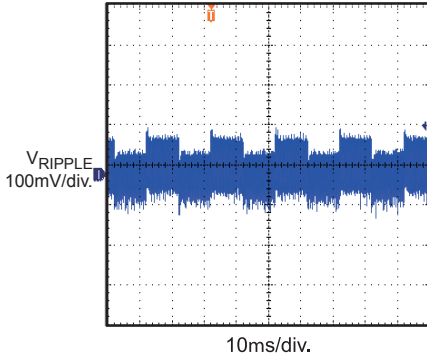

**OLP Protection**

$V_{IN} = 230\text{Vac}$

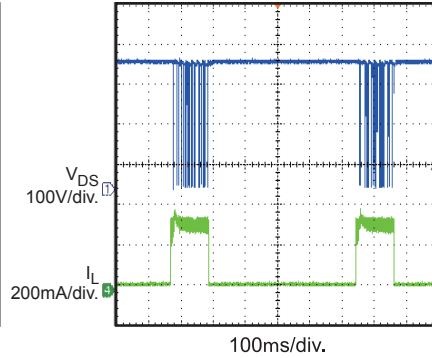

**SCP Protection**

$V_{IN} = 230\text{Vac}$

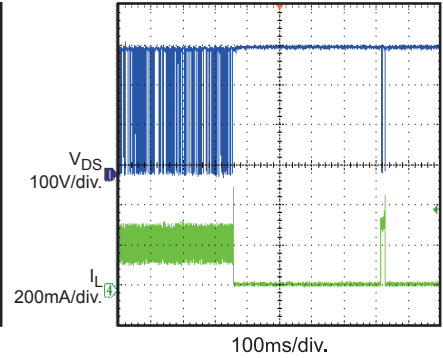

**Thermal Down**

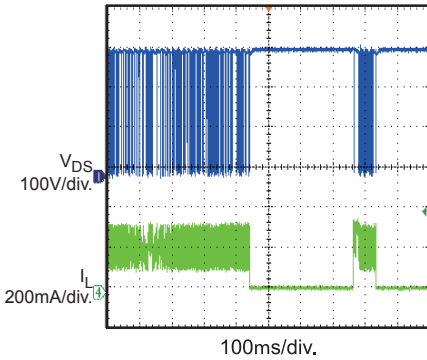

**Open Loop**

Full Load

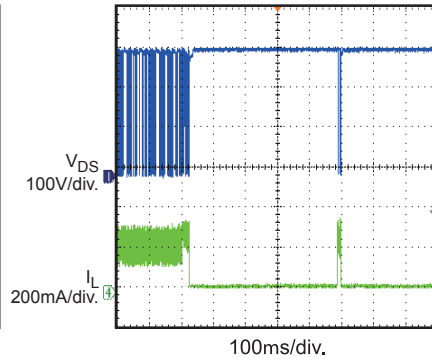

**Open Loop**

No Load

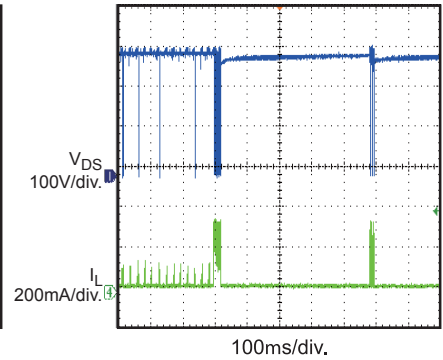

**Conducted EMI**

Two-wire input,  $V_{IN} = 230\text{VAC}$

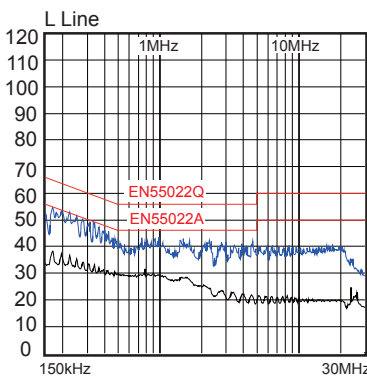

**Conducted EMI**

Two-wire input,  $V_{IN} = 230\text{VAC}$

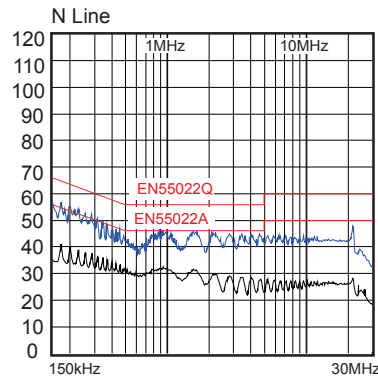

## SURGE PERFORMANCE

With the input capacitors C3 (10 $\mu$ F) and C4 (10 $\mu$ F), the board can pass 1kV surge test. Table 1 shows the capacitance required under normal condition for different surge voltage.

**Table 1: Recommended Capacitor Values**

Surge Voltage	500V	1000V	2000V
C3	1 $\mu$ F	10 $\mu$ F	22 $\mu$ F
C4	1 $\mu$ F	4.7 $\mu$ F	10 $\mu$ F

**PRINTED CIRCUIT BOARD LAYOUT**

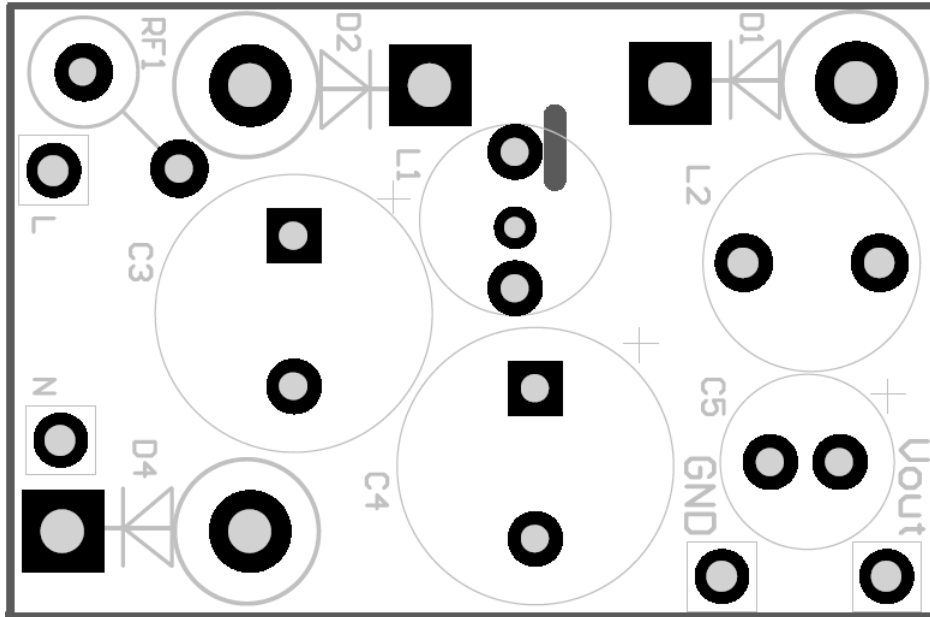

Figure 1 — Top Silk Layer

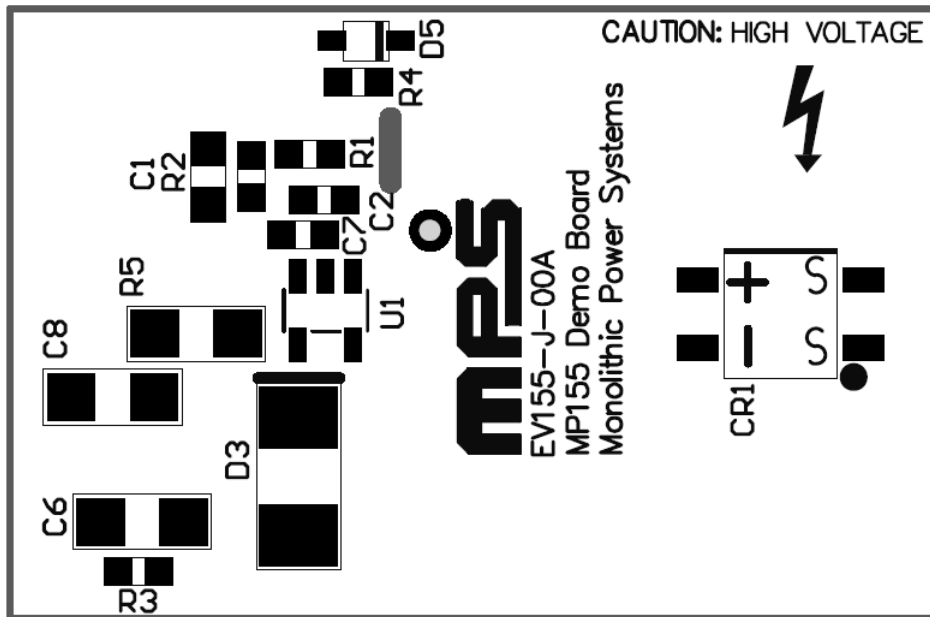

Figure 2 — Bottom Silk Layer



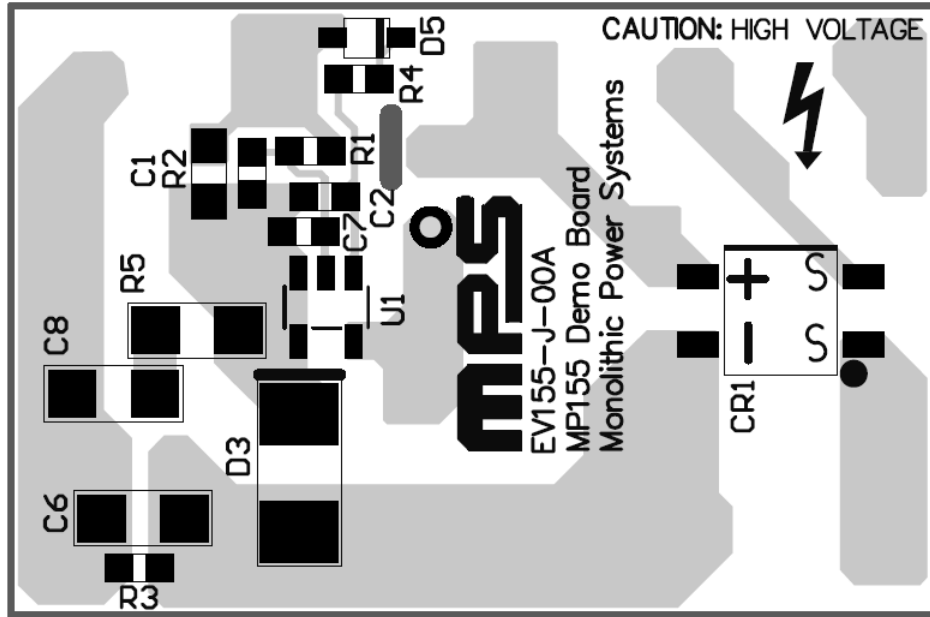

Figure 3 — Bottom Layer

## QUICK START GUIDE

1. Preset Power Supply to  $85V \leq V_{IN} \leq 265V$ .
2. Turn Power Supply off.
3. Connect the Line and Neutral terminals of the power supply output to L and N port.
4. Connect the positive terminal of the load to  $V_{OUT}$  port, and connect the negative terminal of the load to GND port.
5. Turn Power Supply on after making connections.

**NOTICE:** The information in this document is subject to change without notice. Please contact MPS for current specifications. Users should warrant and guarantee that third party Intellectual Property rights are not infringed upon when integrating MPS products into any application. MPS will not assume any legal responsibility for any said applications.