

DESCRIPTION

MP150 is a primary side regulator providing accurate constant voltage (CV) regulation without the Opto-coupler, support Buck, Buck-Boost and Flyback topologies. 500V MOSFET is integrated in the regulator, so very simple structure and low cost can be achieved. These features help to make it a competitive candidate for off-line low power applications, such as home appliance and standby power.

MP150 is a green mode operation regulator. With the load decreasing, the peak current and the switching frequency will both decreasing with the load. As a result, it still offers excellent efficiency performance at light load, thus better average efficiency is achieved.

MP150 features various protections like Thermal Shutdown (TSD), VCC under Voltage Lockout (UVLO), Over Load Protection (OLP), Short Circuit Protection (SCP), Open Loop Protection.

MP150 is available in the TSOT23-5 package.

FEATURES

- Primary side constant voltage (CV) control, supporting Buck, Buck-Boost and Flyback topologies
- Integrated 500V/30Ω MOSFET
- < 150mW No-load power consumption
- Up to 2W output power
- Maximum DCM output current lower than 120mA, maximum CCM output current lower than 200mA
- Frequency Foldback
- Maximum frequency limitation
- Peak Current Compression
- Internal High Voltage Current Source

APPLICATIONS

- Home Appliance, white goods and consumer electronics
- Industrial Controls
- Standby Power

All MPS parts are lead-free and adhere to the RoHS directive. For MPS green status, please visit MPS website under Quality Assurance. "MPS" and "The Future of Analog IC Technology" are Registered Trademarks of Monolithic Power Systems, Inc.

EV150-J-00A EVALUATION BOARD

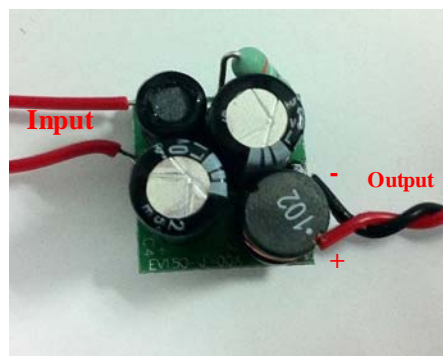

(L x W x H) 1.7cm x 1.7cm x 1.7cm

Board Number	MPS IC Number
EV150-J-00A	MP150GJ

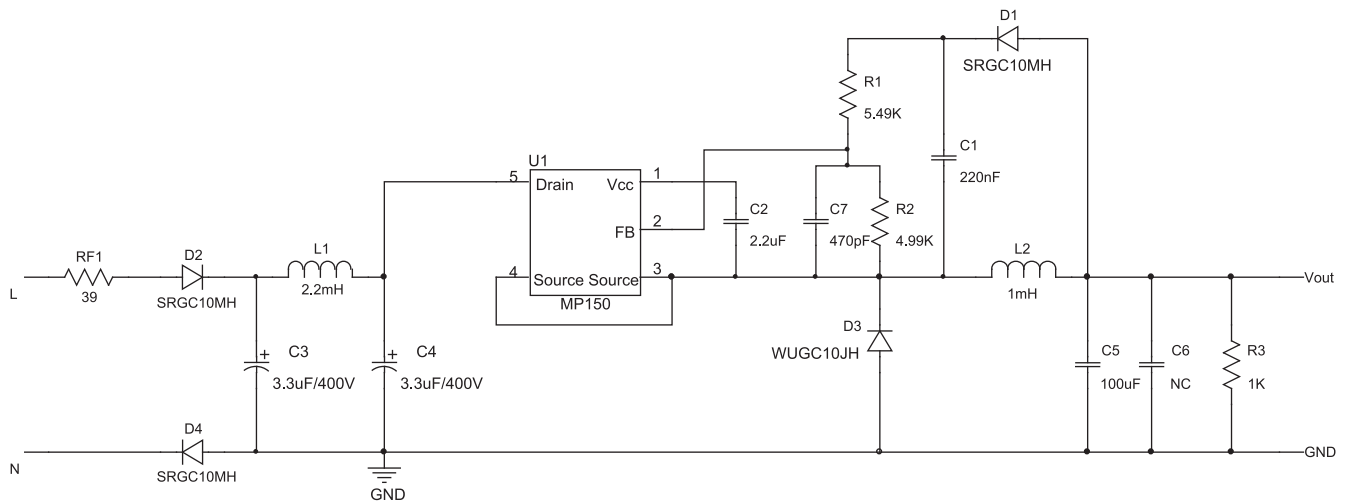
EVALUATION BOARD SCHEMATIC

EV150-J-00A BILL OF MATERIALS

Qty	Ref	Value	Description	Package	Manufacture	Part Number
1	C1	220nF	Ceramic Capacitor, 16V; X7R, 0603	0603	muRata	GRM188R71C224KA01
1	C2	2.2uF	Ceramic Capacitor, 10V, X7R, 0603	0603	muRata	GRM188R71A225KE15D
2	C3, C4	3.3uF/400V	Capacitor, 400V	DIP	Rubycon	400LLE3.3MEFC8X11.5
1	C5	100uF	Ceramic Capacitor, 6.3V, X5R, 1210	1210	muRata	GRM32ER60J107ME20L
1	C7	470pF	Ceramic Capacitor, 50V, X7R, 0603	0603	TDK	C1608X7R1H471K
3	D1, D2, D4	SRGC10MH	Diode;1000V;1A	1206	Maxmega	SRGC10MH
1	D3	WUGC10JH	Diode, 600V, 1A	SMA	ZOWIE	WUGC10JH
1	L1	2.2mH	Inductor, 2.2mH,	DIP	Any	Any
1	L2	1mH	Inductor, 1mH, 2.5, 420mA	DIP	Würth	744743102
1	R1	5.49K	Film Resistor, 1%	0603	Yageo	RC0603FR-075K49L
1	R2	4.99K	Film Resistor, 1%;	0603	Yageo	RC0603FR-074K99L
1	R3	1K	Resistor, 1%	0603	Yageo	RC0603FR-071KL
1	RF1	39	Fuse Resistor; 5%, 1W	DIP	Yageo	FKN1WSJT-52-39R
1	U1	MP150GJ	Buck regulator	TSOT23-5	MPS	MP150GJ

EVB TEST RESULTS

Performance waveforms are tested on the evaluation board.

$V_{IN} = 85\sim 265V_{AC}$, $V_{OUT} = 5V$, $I_{OUT} = 200mA$, $T_A = 25^\circ C$, unless otherwise noted.

Efficiency

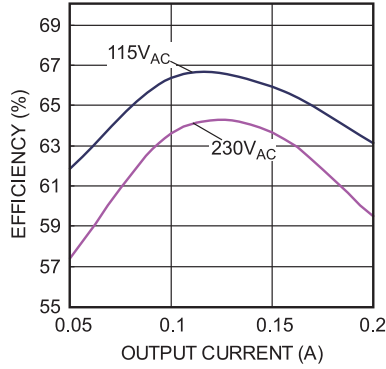

No Load Consumption

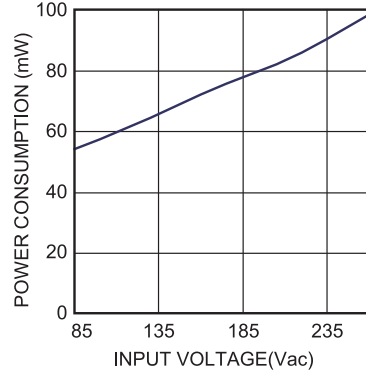

Normal Operation

$V_{IN} = 115V_{AC}$, Full Load

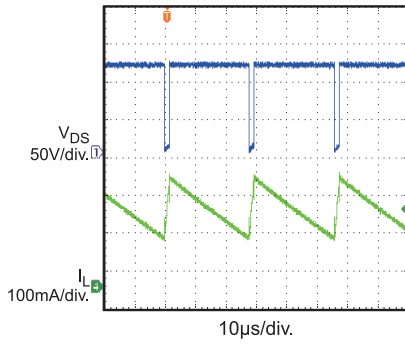

Normal Operation

$V_{IN} = 230V_{AC}$, Full Load

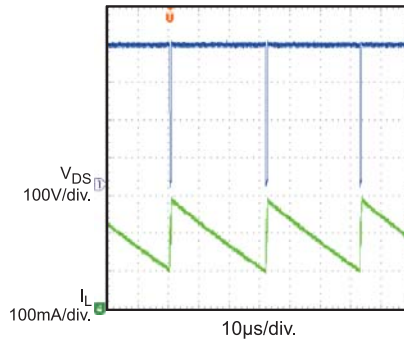

Output Ripple

$V_{IN} = 115V_{AC}$, No Load

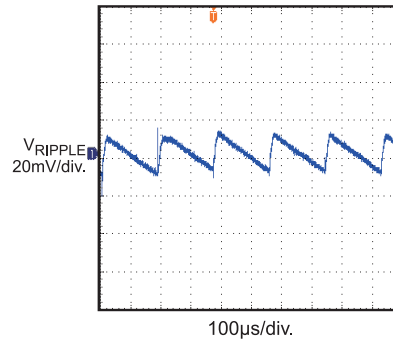

Output Ripple

$V_{IN} = 115V_{AC}$, Full Load

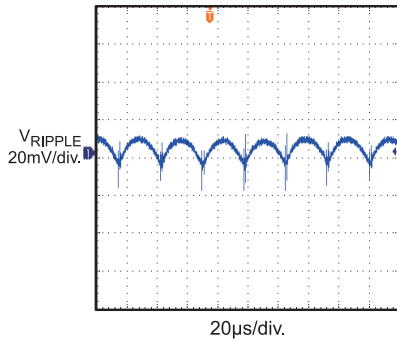

Output Ripple

$V_{IN} = 230V_{AC}$, No Load

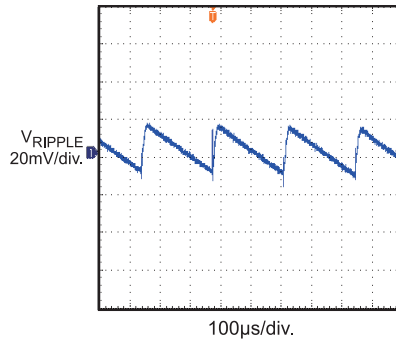

Output Ripple

$V_{IN} = 230V_{AC}$, Full Load

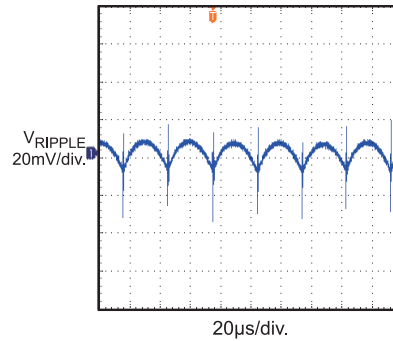

EVB TEST RESULTS *(continued)*

Performance waveforms are tested on the evaluation board.

$V_{IN} = 85\sim 265V_{AC}$, $V_{OUT} = 5V$, $I_{OUT} = 200mA$, $T_A = 25^{\circ}C$, unless otherwise noted.

Soft Start

$V_{IN} = 85V_{AC}$

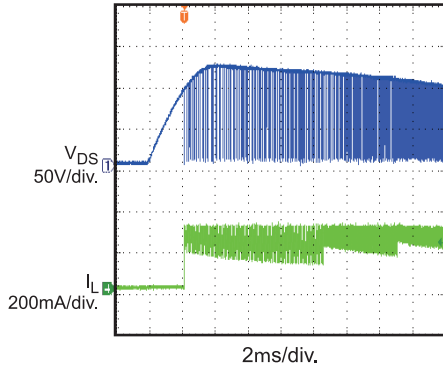

Soft Start

$V_{IN} = 265V_{AC}$

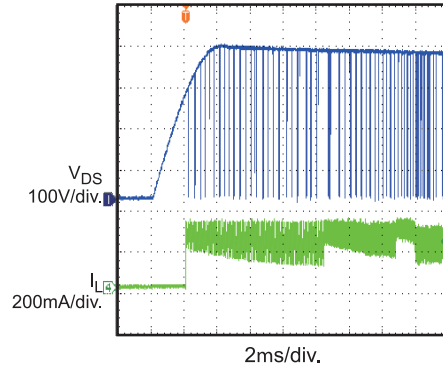

Turn-on Delay

$V_{IN} = 115V_{AC}$, No Load

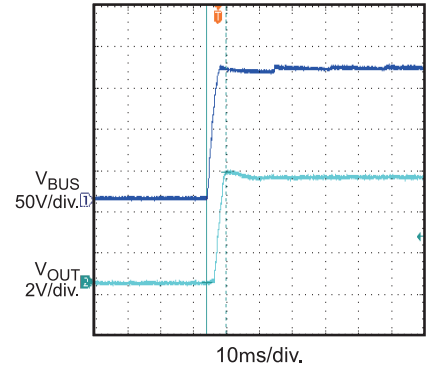

Turn-on Delay

$V_{IN} = 115V_{AC}$, Full Load

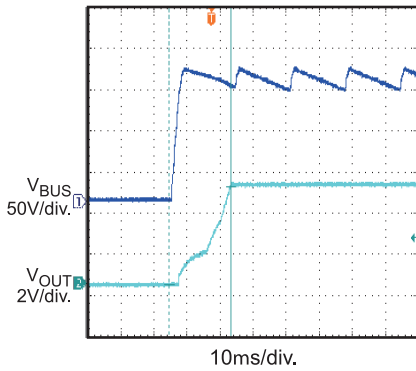

Turn-on Delay

$V_{IN} = 230V_{AC}$, No Load

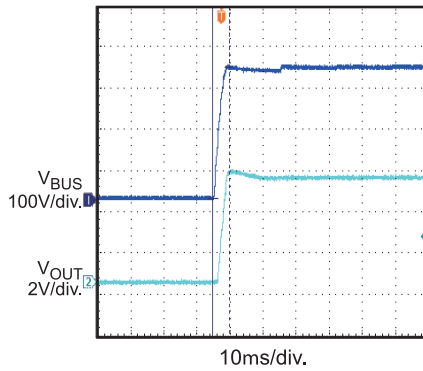

Turn-on Delay

$V_{IN} = 230V_{AC}$, Full Load

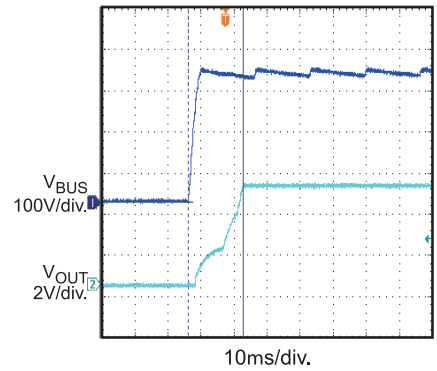

Load Transient

$V_{IN} = 115V_{AC}$,
25% Load to 50% Load

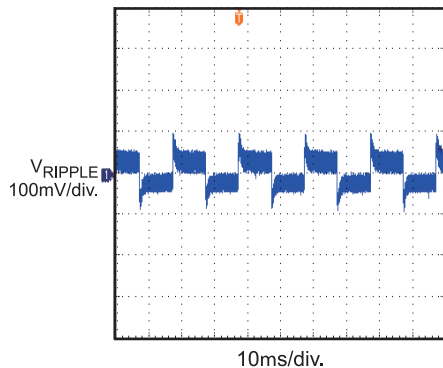

Load Transient

$V_{IN} = 115V_{AC}$,
50% Load to 75% Load

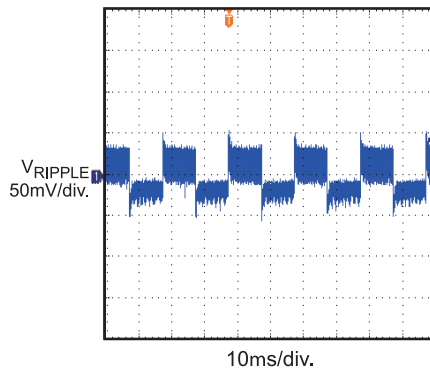

Load Transient

$V_{IN} = 230V_{AC}$,
25% Load to 50% Load

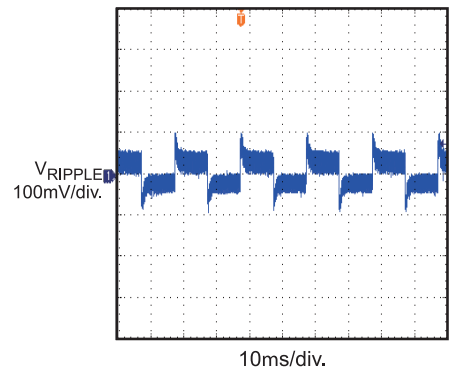

EVB TEST RESULTS (continued)

Performance waveforms are tested on the evaluation board.

$V_{IN} = 85\sim 265V_{AC}$, $V_{OUT} = 5V$, $I_{OUT} = 200mA$, $T_A = 25^{\circ}C$, unless otherwise noted.

Load Transient

$V_{IN} = 230V_{AC}$,
50% Load to 75% Load

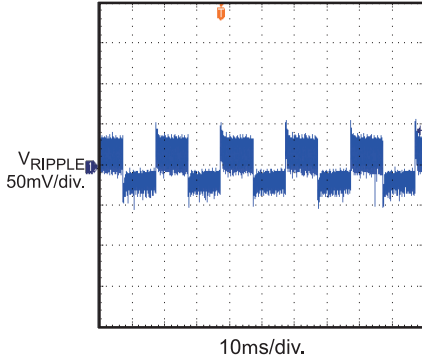

OLP Protection

$V_{IN} = 230V_{AC}$

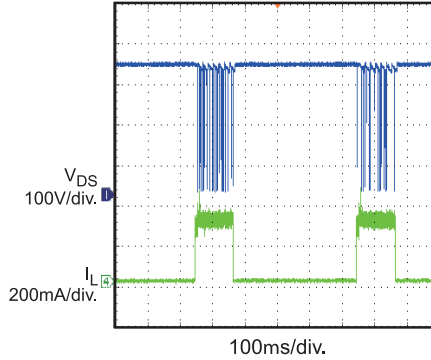

SCP Protection

$V_{IN} = 230V_{AC}$

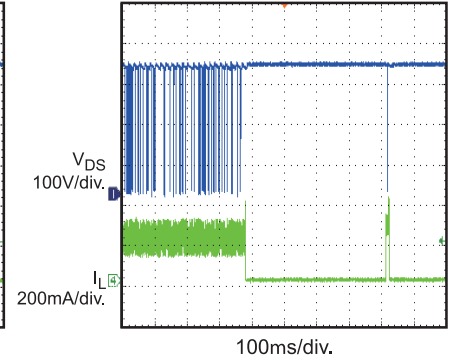

Thermal Down

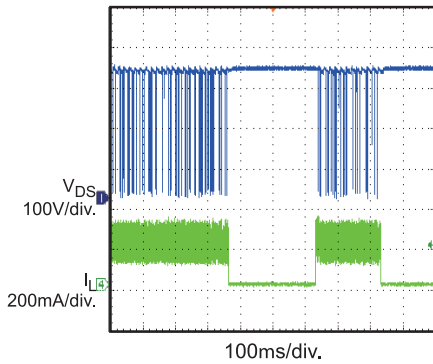

Open Loop

Full Load

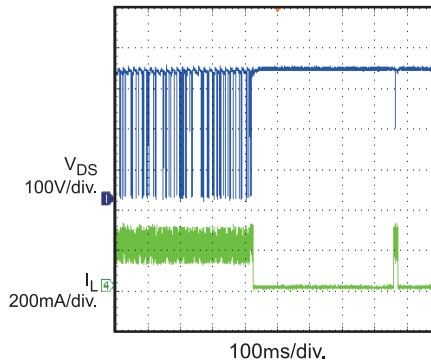

Open Loop

No Load

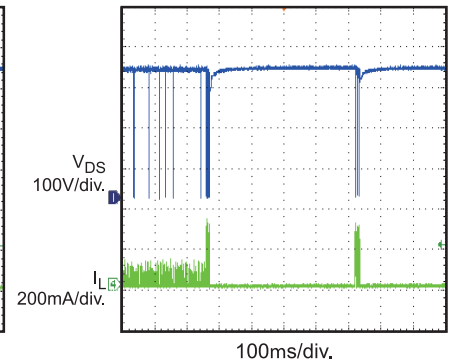

Conducted EMI

Two-Wire Input, $V_{IN} = 230V_{AC}$

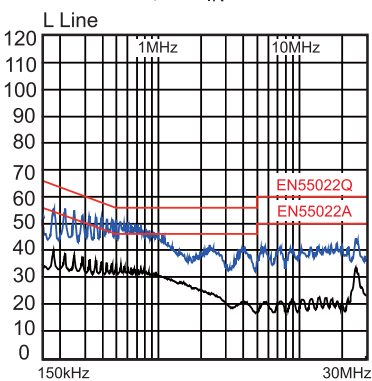

Conducted EMI

Two-Wire Input, $V_{IN} = 230V_{AC}$

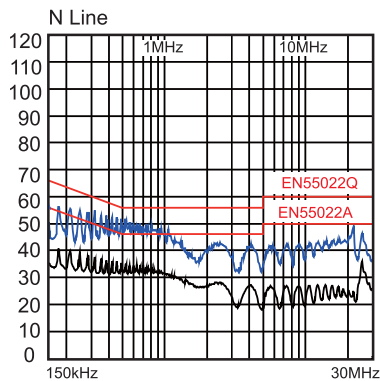

SURGE PERFORMANCE

With the input capacitors C3 (3.3 μ F) and C4 (3.3 μ F), the board can pass 500V surge test. Table 1 shows the capacitance required under normal condition for different surge voltage.

Table 1: Recommended Capacitor Values

Surge Voltage	500V	1000V	2000V
C1	1 μ F	10 μ F	22 μ F
C2	1 μ F	4.7 μ F	10 μ F

PRINTED CIRCUIT BOARD LAYOUT

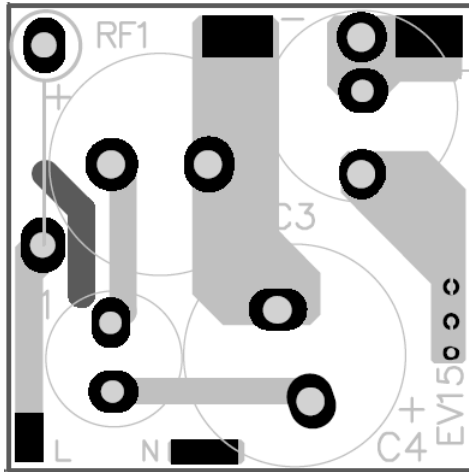

Figure 1 — Top Silk Layer

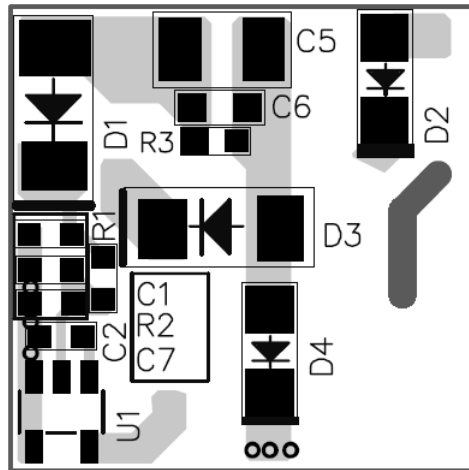

Figure 2 — Bottom Layer

QUICK START GUIDE

1. Preset Power Supply to $85V \leq V_{IN} \leq 265V$.
2. Turn Power Supply off.
3. Connect the Line and Neutral terminals of the power supply output to L and N port.
4. Connect the positive terminal of the load to “+” port, and connect the negative terminal of the load to “-” port.
5. Turn Power Supply on after making connections.

NOTICE: The information in this document is subject to change without notice. Please contact MPS for current specifications. Users should warrant and guarantee that third party Intellectual Property rights are not infringed upon when integrating MPS products into any application. MPS will not assume any legal responsibility for any said applications.