

DESCRIPTION

The MP9115 is a fully integrated, internally compensated 1.2MHz fixed frequency PWM step-down converter. It is ideal for powering portable equipment that runs from a single cell Lithium-Ion (Li+) Battery, with an input range from 2.7V to 6V. The MP9115 can provide up to 2.5A of load current with output voltage as low as 0.8V. It can also operate at 100% duty cycle for low dropout applications.

With peak current mode control and internal compensation, the MP9115 is stable with ceramic capacitors and small inductors. Fault condition protection includes cycle-by-cycle current limiting and thermal shutdown.

MP9115 is available in the small 10-pin 3mmx3mm TQFN package.

FEATURES

- Output Adjustable from 0.8V to V_{IN}
- Up to 91% Efficiency
- 100% Duty Cycle for Low Dropout Applications
- 1 μ A Shutdown Current
- 1.2MHz Fixed Switching Frequency
- 2.7V-6V Input Operation Range
- 3A Peak Output Current
- Stable with Low ESR Output Ceramic Capacitors
- Thermal Shutdown
- Cycle-by-Cycle Over Current Protection
- Short circuit protection
- No reverse current of LS MOS for Pre-bias start up
- Available in 10-pin 3x3mm TQFN

APPLICATIONS

- Smart Phones
- PDA's
- DVD+/-RW Drives
- Digital Cameras
- Portable Instruments

"MPS" and "The Future of Analog IC Technology" are Trademarks of Monolithic Power Systems, Inc.

TYPICAL APPLICATION

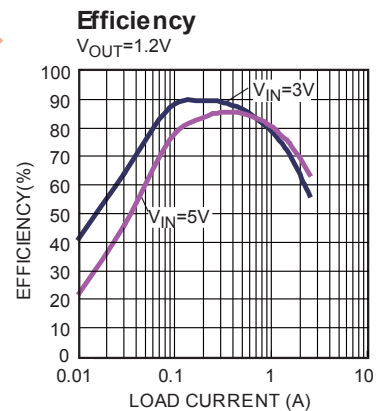
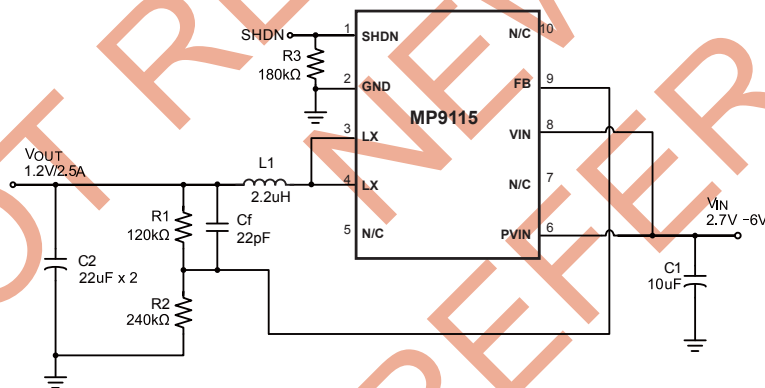

ORDERING INFORMATION

Part Number*	Package	Top Marking	Free Air Temperature (T _A)
MP9115DQT	TQFN10 (3mm x 3mm)	2N	-40°C to +85°C

*For Tape & Reel, add suffix -Z (eg. MP9115DQT-Z);

For RoHS compliant packaging, add suffix -LF (eg. MP9115DQT-LF-Z)

PACKAGE REFERENCE

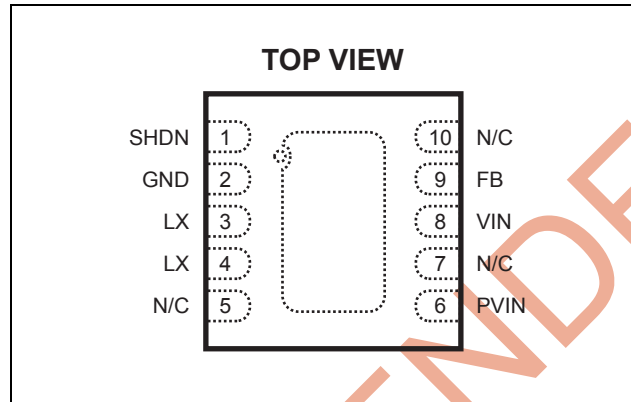

ABSOLUTE MAXIMUM RATINGS ⁽¹⁾

PVIN, VIN to GND.....	-0.3V to + 6.5V
SW to GND	-0.3V to V _{IN} + 0.3V
EN, FB to GND	-0.3V to +6.5V
Operating Temperature.....	-40°C to +85°C
Continuous Power Dissipation (T _A = +25°C) ⁽²⁾	2.5W
Junction Temperature.....	150°C
Lead Temperature	260°C
Storage Temperature.....	-65°C to +150°C

Recommended Operating Conditions ⁽³⁾

Supply Voltage V _{IN}	2.7V to 6V
Operating Junct. Temp (T _J).....	-40°C to +125°C

Thermal Resistance ⁽⁴⁾	θ_{JA}	θ_{JC}
TQFN10 (3x3mm).....	50	12

Notes:

- Exceeding these ratings may damage the device.
- The maximum allowable power dissipation is a function of the maximum junction temperature T_J(MAX), the junction-to-ambient thermal resistance θ_{JA} , and the ambient temperature T_A. The maximum allowable continuous power dissipation at any ambient temperature is calculated by P_D(MAX)=(T_J(MAX)-T_A)/ θ_{JA} . Exceeding the maximum allowable power dissipation will cause excessive die temperature, and the regulator will go into thermal shutdown. Internal thermal shutdown circuitry protects the device from permanent damage.
- The device is not guaranteed to function outside of its operating conditions.
- Measured on JESD51-7, 4-layer PCB.

ELECTRICAL CHARACTERISTICS ⁽⁵⁾
 $V_{IN} = PV_{IN} = 3.6V$, $V_{SHDN} = GND$, $T_A = +25^{\circ}C$, unless otherwise noted.

Parameters	Symbol	Condition	Min	Typ	Max	Units
Supply Current	I_{IN}	$V_{SHDN} = 0V$, $V_{FB} = 0.9V$		600	900	μA
Shutdown Current	I_{SHUT}	$V_{SHDN} = V_{IN}$, $V_{IN} = 6V$		0.01	1	μA
Thermal Shutdown Trip Threshold	T_{SD}	Hysteresis = $20^{\circ}C$		150		$^{\circ}C$
SHDN Trip Threshold	$SHDN_{VTH}$	$-40^{\circ}C \leq T_A \leq +85^{\circ}C$	0.3	1.0	1.5	V
SHDN Input Current	I_{SHDN}	$V_{SHDN} = 0V$ to $6.5V$	-5		5	μA
IN Undervoltage Lockout Threshold	$INUV_{VTH}$	Rising Edge	2.15	2.40	2.65	V
IN Undervoltage Lockout Hysteresis	$INUV_{HYS}$			160		mV
Regulated FB Voltage	V_{FB}	$T_A = +25^{\circ}C$	0.784	0.800	0.816	V
		$-40^{\circ}C \leq T_A \leq +85^{\circ}C$	0.776	0.800	0.824	
FB Input Bias Current	I_{FB}	$V_{FB} = 0.9V$	-50	-2	+50	nA
PFET On Resistance	HS_{RDS-ON}	$I_{LX} = 100mA$		0.25		Ω
NFET On Resistance	LS_{RDS-ON}	$I_{LX} = -100mA$		0.20		Ω
LX Leakage Current	$LXHS_{LKG}$	$V_{SHDN} = 3.6V$; $V_{IN} = 6V$; $V_{LX} = 0V$	-1		1	μA
	$LXLS_{LKG}$	$V_{SHDN} = 3.6V$; $V_{IN} = 6V$; $V_{LX} = 6V$	-5		5	μA
PFET Peak Current Limit	I_{LIMIT}	Duty Cycle=100%,	3.5	4.5	6	A
Switching Frequency	F_{SW}		1.0	1.2	1.4	MHz

Notes:

 5) Production test at $+25^{\circ}C$. Specifications over the temperature range are guaranteed by design and characterization.

PIN FUNCTIONS

Pin #	Name	Description
1	SHDN	Shut down input, "High" disables MP9115.
2	GND	Ground pin
3,4	LX	Switching node to the inductor
5	N/C	No connection
6	PVIN	Input supply pin for power FET
7	N/C	No connection
8	VIN	Input Supply pin for controller
9	FB	Feedback input pin
10	N/C	No connection

TYPICAL PERFORMANCE CHARACTERISTICS

$V_{IN} = 5V$, $V_{OUT} = 1.2V$, $L=2.2\mu H$, $T_A = +25^\circ C$, unless otherwise noted.

Efficiency vs. Load Current
 $V_{OUT}=1.2V$

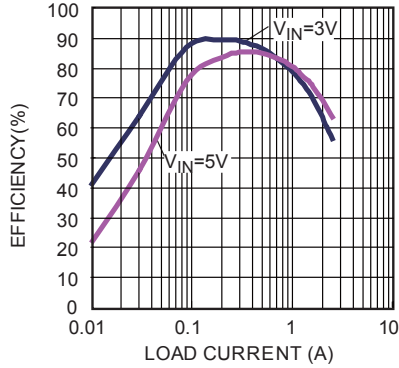

Efficiency vs. Load Current
 $V_{OUT}=2.5V$

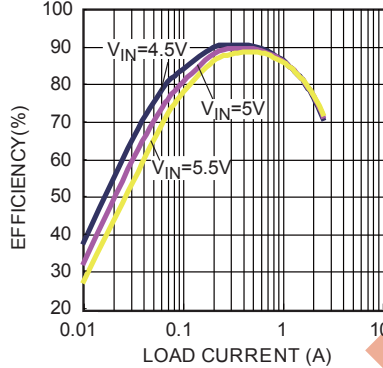

Supply Current vs. Input Voltage

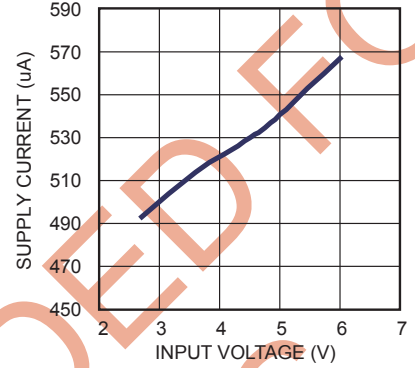

Case Temperature Rise vs. Output Current

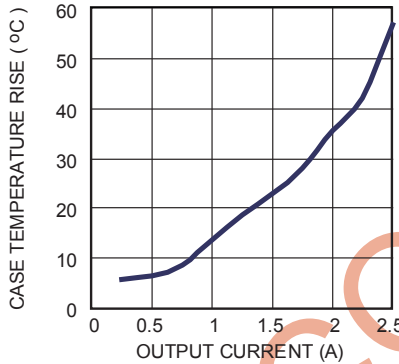

Load Regulation

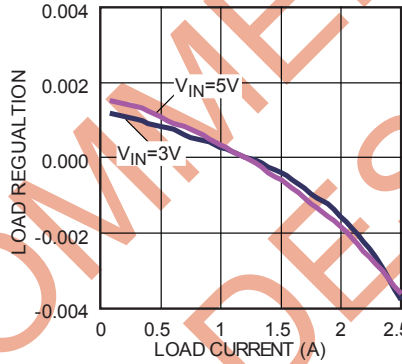

Line Regulation

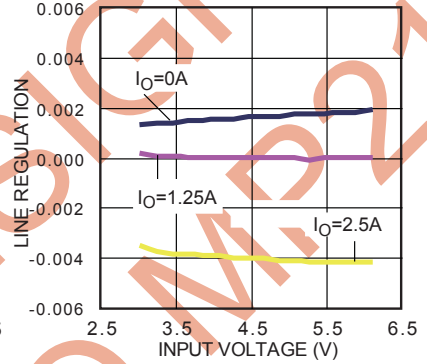

Ipeak vs. Duty

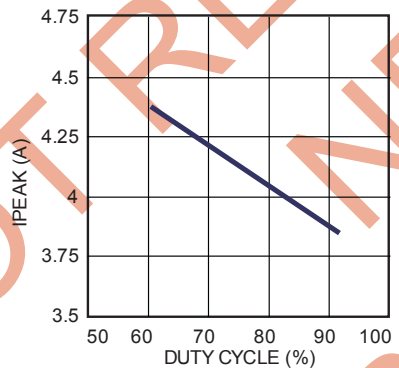

TYPICAL PERFORMANCE CHARACTERISTICS (continued)

$V_{IN} = 5V$, $V_{OUT} = 1.2V$, $L=2.2\mu H$, $T_A = +25^\circ C$, unless otherwise noted.

Short Entry

Full Load

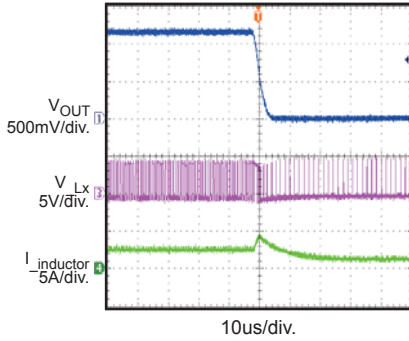

Short Recovery

Full Load

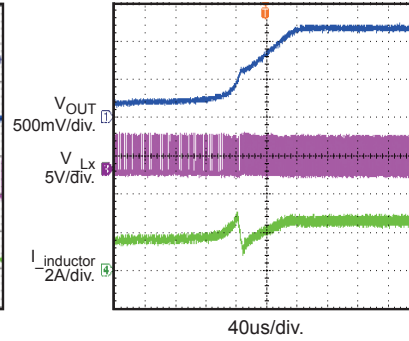

Power up without Load

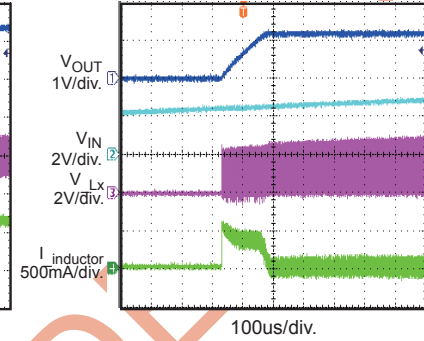

Power up with 2.5A Load

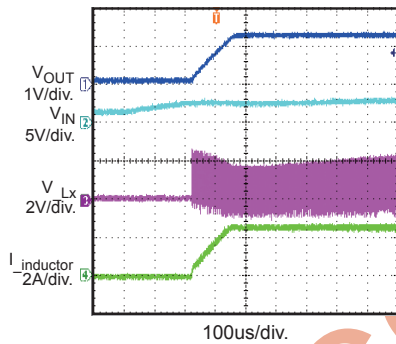

SHDN Start up without Load

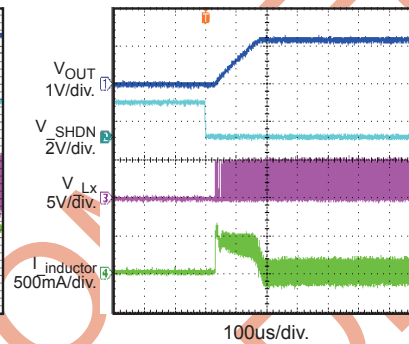

SHDN Start Up with 2.5A Load

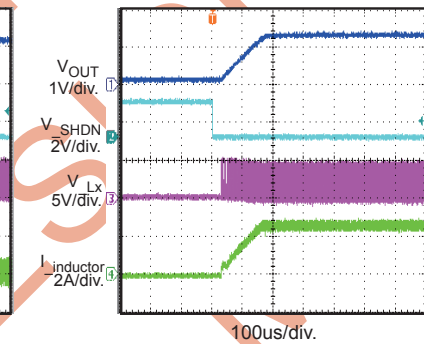

Input Ripple Voltage

Full Load

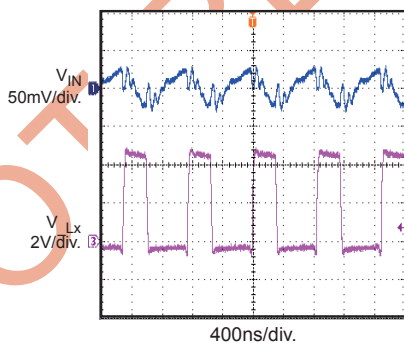

Output Ripple Voltage

Full Load

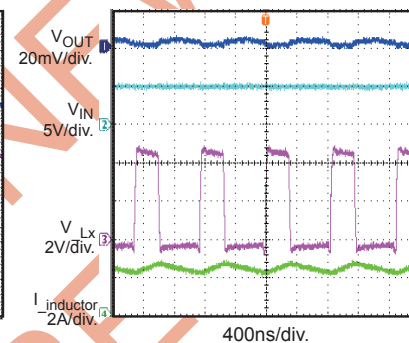

Load Transient Response

(1.25A-2.5A, Slew Rate:2.5A/uS)

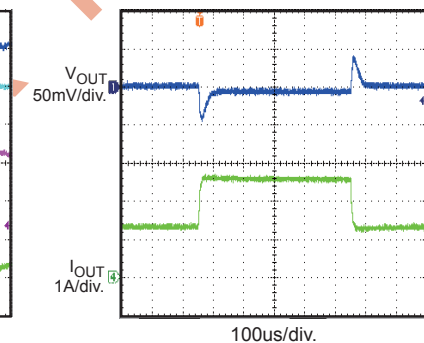

FUNCTIONAL BLOCK DIAGRAM

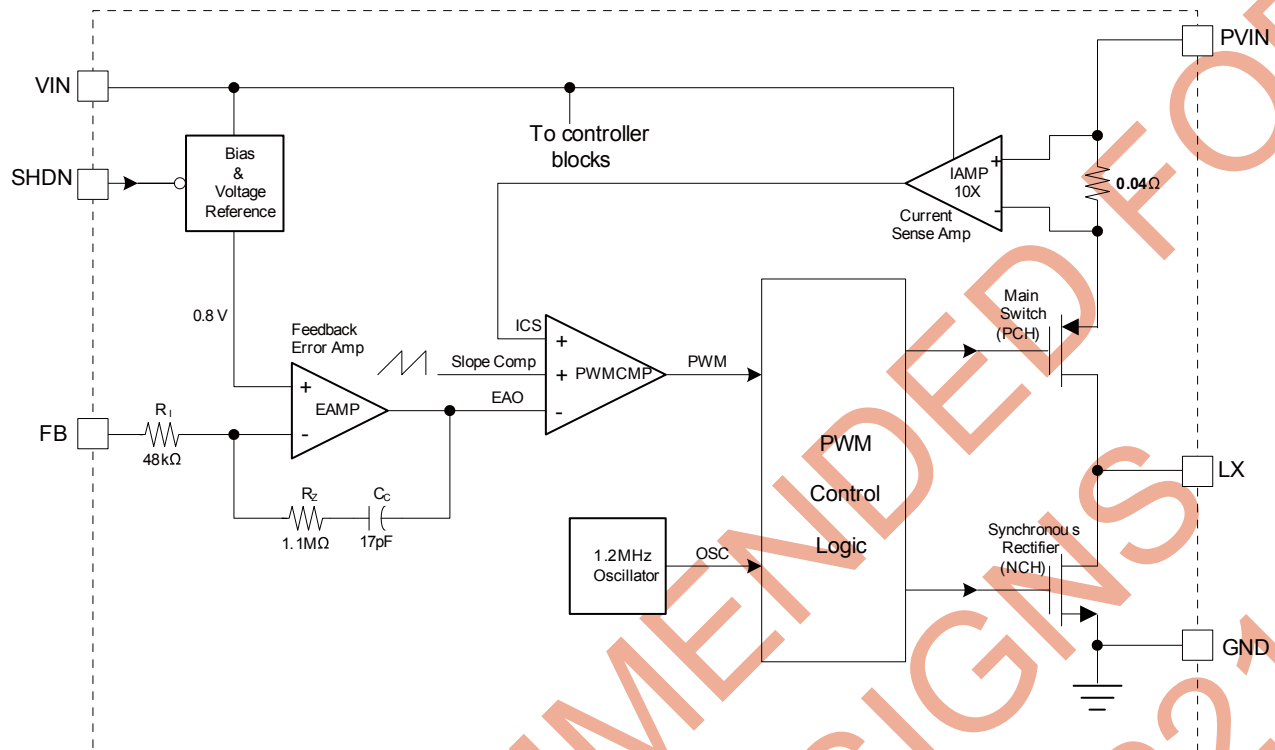

Figure 1—Functional Block Diagram

OPERATION

The MP9115 is a fixed frequency 1.2MHz current mode 2.5A step-down converter, optimized for low voltage, Li-Ion battery powered applications where high efficiency and small size are critical. MP9115 integrates a high side PFET main switch and a low side synchronous rectifier. It always operates in continuous conduction mode, simplifies the control scheme and eliminates the random spectrum noise due to discontinuous conduction mode.

The steady state duty cycle D for this mode can be calculated as:

$$D = T_{ON} \times f_{OSC} \times 100\% \approx \frac{V_{OUT}}{V_{IN}} \times 100\%$$

Where T_{ON} is the main switch on time and f_{OSC} is the oscillator frequency (1.2MHz typ.).

Current Mode PWM Control

Slope compensated current mode PWM control provides stable switching and cycle-by-cycle current limiting for superior load and line response as well as protection of the internal main switch and synchronous rectifier. The MP9115 switches at a constant frequency (1.2MHz) and modulates the inductor peak current to regulate the output voltage. Specifically, for each cycle the PWM controller forces the inductor peak current to an internal reference level derived from the feedback error voltage. At normal operation, the main switch is turned on at each rise edge of the internal oscillator, and remains on for a certain period of time to ramp up the inductor current. As soon as the inductor current reaches the reference level, the main switch is turned off and immediately the synchronous rectifier will be turned on to provide the inductor current. In forced PWM mode, the synchronous rectifier will stay on until the next oscillator cycle.

Dropout Operation

The MP9115 allows the main switch to remain on for more than one switching cycle to increase the duty cycle when the input voltage is dropping close to the output voltage. When the duty cycle reaches 100%, the main switch is held on continuously to deliver current to the output up to the PFET current limit. In this case, the output voltage becomes the input voltage minus the voltage drop across the main switch and the inductor.

Maximum Load Current

The MP9115 can operate down to 2.7V input voltage; however the maximum load current decreases at lower input due to a large IR drop on the main switch and synchronous rectifier. The slope compensation signal reduces the peak inductor current as a function of the duty cycle to prevent sub-harmonic oscillations at duty cycles greater than 50%. Conversely, the current limit increases as the duty cycle decreases.

Short Circuit Protection

When the output is shorted to ground, the oscillator frequency is reduced to prevent the inductor current from increasing beyond the PFET current limit. The PFET current limit is also reduced to lower the short circuit current. The frequency and current limit will return to the normal values once the short circuit condition is removed and the feedback voltage approaches 0.8V.

APPLICATION INFORMATION

Output Voltage Setting

The output voltage is set by the external resistor divider:

$$V_{OUT} = 0.8 \cdot \left(1 + \frac{R_1}{R_2}\right)$$

The feedforward capacitor is recommended when output voltage is low, as Figure 2 shows.

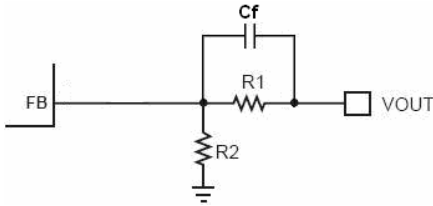

Figure 2—Feedback Network

Table 1 lists the recommended resistors and feedforward capacitors value for common output voltages.

Table 1—Resistor and Feedforward Capacitor Selection for Common Output Voltages

Vout (V)	R1 (kΩ)	R2 (kΩ)	Cf (pF)	C2 (uF) Ceramic	L1 (uH)
1.2	120	240	22	44	2.2
1.5	120	137	18	44	2.2
1.8	120	95.3	18	44	2.2
2.5	120	56.2	NS	44	2.2
3.3	120	38.3	NS	44	2.2

Inductor Selection

A 1μH to 10μH inductor with DC current rating at least 25% higher than the maximum load current is recommended for most applications. For best efficiency, the inductor DC resistance shall be <200mΩ. See Table2 for recommended inductors and manufacturers. For most designs, the inductance value can be derived from the following equation:

$$L = \frac{V_{OUT} \times (V_{IN} - V_{OUT})}{V_{IN} \times \Delta I_L \times f_{OSC}}$$

Where ΔI_L is inductor ripple current. Choose inductor ripple current approximately 30% of the maximum load current, 2.5A.

The maximum inductor peak current is:

$$I_{L(MAX)} = I_{LOAD} + \frac{\Delta I_L}{2}$$

Table 2—Suggested Inductors

Manufacturer	Part Number	Inductance (μH)	Dimensions LxWxH (mm ³)
Würth	7447745022	2.2	5.8X5.2X2
TDK	SLF6045T-2R2N3R3-3PF	2.2	6X6X4.5

Input Capacitor C_{IN} Selection

The input capacitor reduces the surge current drawn from the input and switching noise from the device.

Ceramic capacitors with X5R or X7R dielectrics are highly recommended because of their low ESR and small temperature coefficients. For most applications, a 10μF capacitor is sufficient.

Output Capacitor C_{OUT} Selection

The output capacitor keeps output voltage ripple small and ensures regulation loop stable. The output capacitor impedance shall be low at the switching frequency. Ceramic capacitors with X5R or X7R dielectrics are recommended. For forced PWM mode operation, the output ripple ΔV_{OUT} is approximately:

$$\Delta V_{OUT} = \frac{V_{OUT} \cdot (V_{IN} - V_{OUT})}{V_{IN} \cdot f_{OSC} \cdot L} \left(R_{ESR} + \frac{1}{8} \cdot \frac{1}{f_{OSC} \cdot C_{OUT}} \right)$$

For most applications, a 33μF capacitor is sufficient.

Thermal Dissipation

Power dissipation shall be considered when operates MP9115 at maximum 2.5A output current. If the junction temperature rises above 150°C, MP9115 will be shut down by internal thermal protection circuitry.

The junction-to-ambient thermal resistance of the 10-pin TQFN (3mm x 3mm) $R_{\theta JA}$ is 50°C/W. The maximum allowable power dissipation is about1.6W when MP9115 is operating in a 70°C ambient temperature environment:

$$PD_{MAX} = \frac{150^{\circ}C - 70^{\circ}C}{50^{\circ}C/W} = 1.6W$$

PC Board Layout

The high current paths (GND, PVIN and Lx) should be placed very close to the device with short, direct and wide traces. Input capacitors

should be placed as close as possible to the respective PVIN and GND pins. The external feedback resistors shall be placed next to the FB pins. Keep the switching nodes Lx short and away from the feedback network.

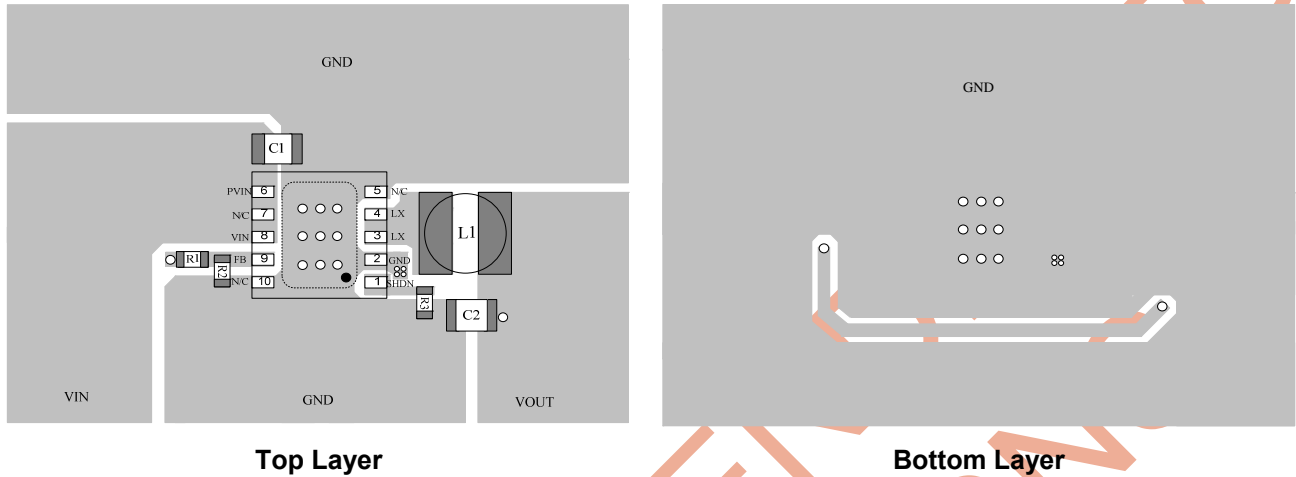

Figure 3— PCB Layout

NOT RECOMMENDED FOR NEW DESIGN REFER TO MP2143

