

### DESCRIPTION

The MP62040-1/MP62041-1 Power Distribution Switch is designed for high-side load switch applications. The switch operates from 1.7V to 5.5V nominal input voltage and includes an 85mΩ Power MOSFET to handle up to 2A continuous load.

The MP62040-1/MP62041-1 has slew rate control with 115µs rise time to limit inrush current when enabling the switch. In addition, the part features a discharge function that provides a resistive discharge path for the external output capacitor when the part is disabled.

The built-in level shift function allows a logic signal on enable input that may be different from the supply voltage to switch the high side P-channel MOSFET ON or OFF.

The MP62040-1/MP62041-1 is available in an ultra-small UTQFN4 package, with ultra-low height (0.55mm typ.).

### FEATURES

- 2A Continuous Current
- 1.7V to 5.5V Supply Range
- Output Discharge Function
- Soft Start: 115µs
- 1µA Shutdown Current
- 85mΩ MOSFET
- Active High & Active Low Options
- Space Saving 1.6x1.2mm UTQFN4 Package (0.55mm Height)

### APPLICATIONS

- Load Switch in Portable Applications
- Battery Switch-over Circuits

For MPS green status, please visit MPS website under Quality Assurance. "MPS" and "The Future of Analog IC Technology" are Registered Trademarks of Monolithic Power Systems, Inc.

### TYPICAL APPLICATION

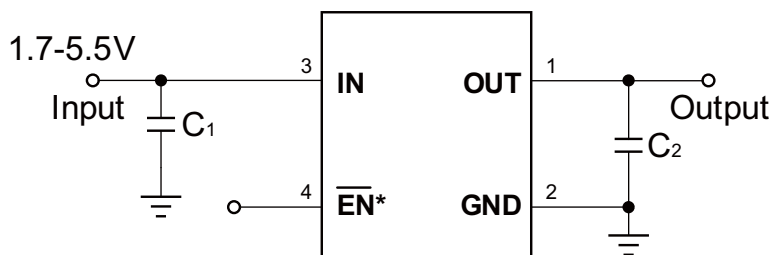

MP62040-1/MP62041-1

(\*: EN is active high for MP62041-1)  
Single Channel

### ORDERING INFORMATION

Part Number	Enable	Switch	Maximum Continuous Load Current	Package	Top Marking	Free Air Temperature (T <sub>A</sub> )
MP62040DQFU-1*	Active Low	Single	2A	UTQFN4	AFY	-40°C to +85°C
MP62041DQFU-1	Active High			UTQFN4	5UY	

\* For Tape & Reel, add suffix -Z (e.g. MP62040DQFU-1-Z).  
 For RoHS compliant packaging, add suffix -LF (e.g. MP62040DQFU-1-LF-Z)

### PACKAGE REFERENCE

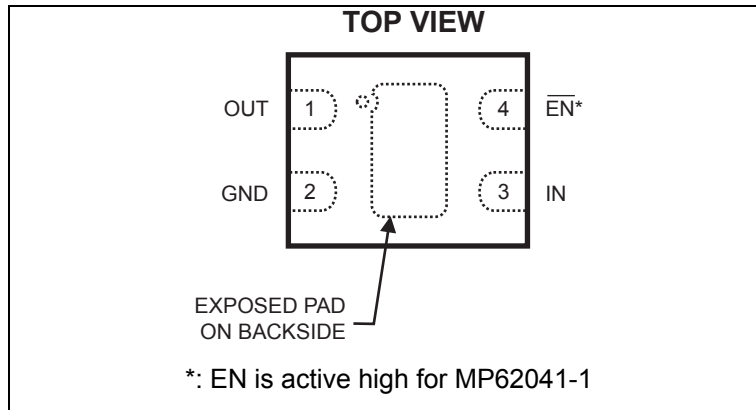

### ABSOLUTE MAXIMUM RATINGS <sup>(1)</sup>

IN .....	-0.3V to +6.0V
EN, OUT to GND .....	-0.3V to +6.0V
Continuous Power Dissipation (T <sub>A</sub> = +25°C) <sup>(2)</sup>	
UTQFN4.....	0.7W
Junction Temperature.....	150°C
Lead Temperature .....	260°C
Storage Temperature.....	-65°C to +150°C
Maximum Junction Temp. (T <sub>J</sub> ).....	+125°C

<b>Thermal Resistance <sup>(3)</sup></b>	<b>θ<sub>JA</sub></b>	<b>θ<sub>JC</sub></b>
UTQFN4 .....	173 .....	127.. °C/W

**Notes:**

- 1) Exceeding these ratings may damage the device.
- 2) The maximum allowable power dissipation is a function of the maximum junction temperature T<sub>J</sub>(MAX), the junction-to-ambient thermal resistance θ<sub>JA</sub>, and the ambient temperature T<sub>A</sub>. The maximum allowable continuous power dissipation at any ambient temperature is calculated by P<sub>D</sub>(MAX)=(T<sub>J</sub>(MAX)-T<sub>A</sub>)/θ<sub>JA</sub>. Exceeding the maximum allowable power dissipation will cause excessive die temperature, and the regulator will go into thermal shutdown. Internal thermal shutdown circuitry protects the device from permanent damage.
- 3) Measured on JESD51-7, 4-layer PCB.

## ELECTRICAL CHARACTERISTICS

$V_{IN}=3.6V$ ,  $T_A=+25^{\circ}C$ , unless otherwise noted.

Parameter	Symbol	Condition	Min	Typ	Max	Units
IN Voltage Range	$V_{IN}$		1.7		5.5	V
Supply Current		Device active, $V_{IN}=3.6V$ , $I_{OUT}=0$		2		$\mu A$
Shutdown Current		Device disable, $V_{IN}=5.5V$ , $V_{OUT}=float$			1	$\mu A$
FET On_Resistance		$V_{IN}=1.7V$ , $I_{OUT}=100mA$		165	225	m $\Omega$
		$V_{IN}=1.8V$ , $I_{OUT}=100mA$		155	215	m $\Omega$
		$V_{IN}=2.5V$ , $I_{OUT}=100mA$		130	200	m $\Omega$
		$V_{IN}=3.6V$ , $I_{OUT}=100mA$		100	140	m $\Omega$
		$V_{IN}=4.5V$ , $I_{OUT}=100mA$		85	115	m $\Omega$
EN Input Logic High Voltage		$V_{IN} = 1.7V$ to $4.5V$ , $I_D = -250\mu A$	1.2			V
EN Input Logic Low Voltage		$V_{IN} = 1.7V$ to $4.5V$ , $I_D = -250\mu A$			0.4	V
EN Input Current		Device active, $V_{IN} = 5.5V$		2	4	$\mu A$
Discharge Resistance		Device disable, $V_{IN} = 3.6V$ , $I_{TEST} = 1mA$		200	300	$\Omega$
$V_{OUT}$ Rising Time <sup>(4)</sup>	$T_r$	$V_{IN}=3.6V$ , $I_{OUT}=100mA$ , $C_L=1\mu F$	75	115	200	$\mu s$
$V_{OUT}$ Falling Time <sup>(5)</sup>	$T_f$	$V_{IN}=3.6V$ , $I_{OUT}=100mA$ , $C_L=1\mu F$	65	75	100	$\mu s$
Turn On_Time <sup>(6)</sup>	$T_{on}$	$V_{IN}=3.6V$ , $I_{OUT}=100mA$ , $C_L=1\mu F$		235	350	$\mu s$
Turn Off_Time <sup>(7)</sup>	$T_{off}$	$V_{IN}=3.6V$ , $I_{OUT}=100mA$ , $C_L=1\mu F$		100	200	$\mu s$

**Notes:**

- 4) Measured from 10% to 90%.
- 5) Measured from 90% to 10%.
- 6) Measured from (50%) EN signal to (90%) output signal.
- 7) Measured from (50%) EN signal to (10%) output signal.

## PIN FUNCTIONS

UTQFN	Name	Description
1	OUT	IN-to-OUT Power-Distribution Output
2	GND	Ground and the thermal pad should both be connected to electrical ground.
3	IN	Input Voltage. Accepts 1.7V to 5.5V input.
4	$\overline{\text{EN}}$	Active Low: (MP62040-1), Active High: (MP62041-1)

## PARAMETER MEASUREMENT INFORMATION

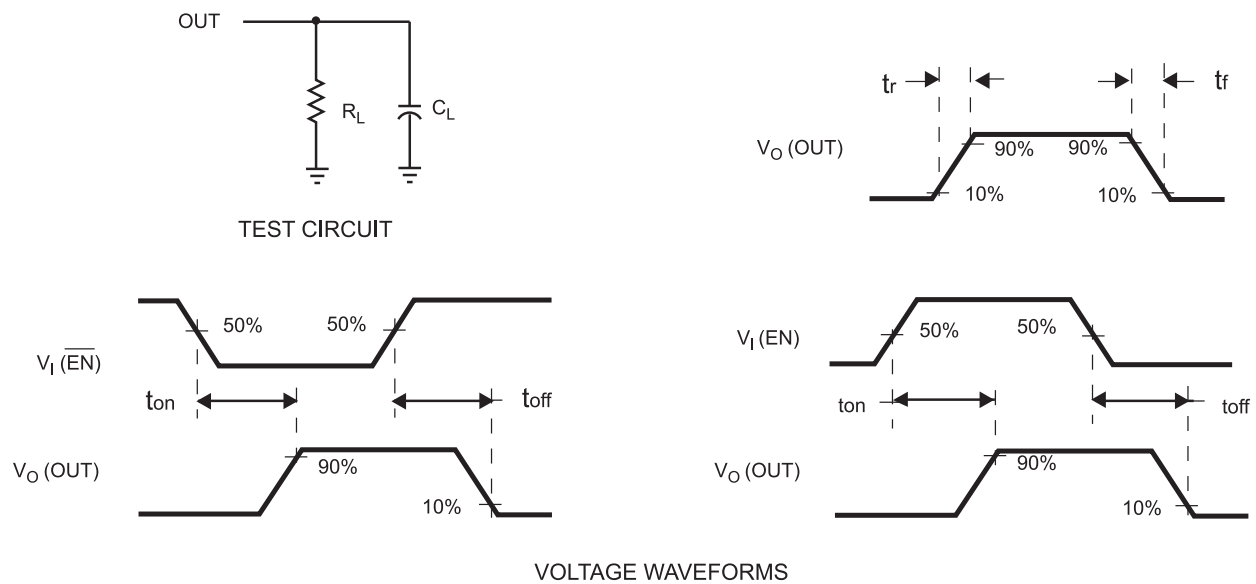

**Figure 1 — Definition of Tr, Tf, Ton and Toff**

## TYPICAL PERFORMANCE CHARACTERISTICS

$V_{IN} = V_{EN} = 3.6V$ ,  $C_L = 1\mu F$ ,  $T_A = +25^\circ C$ , unless otherwise noted.

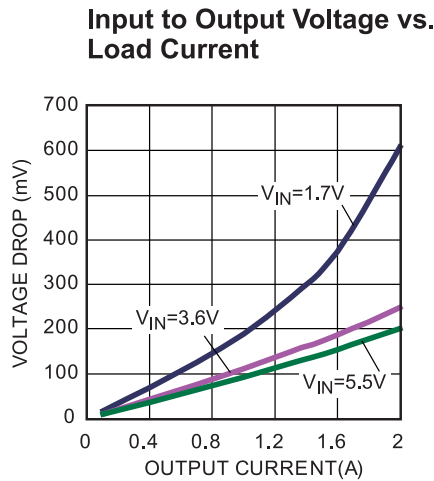
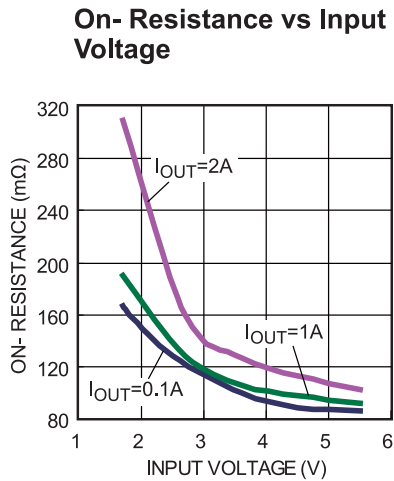
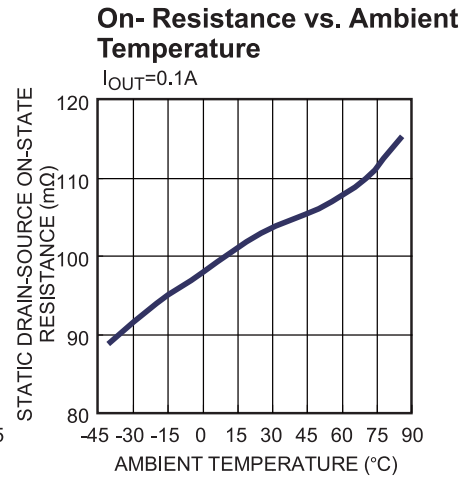
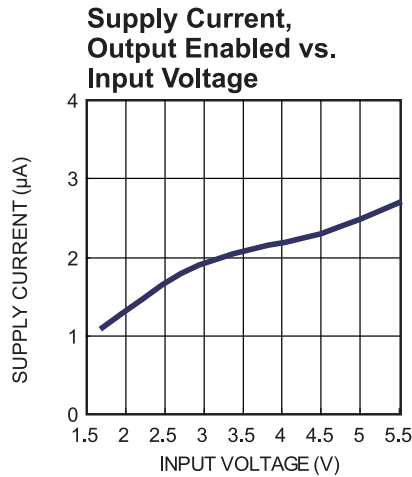
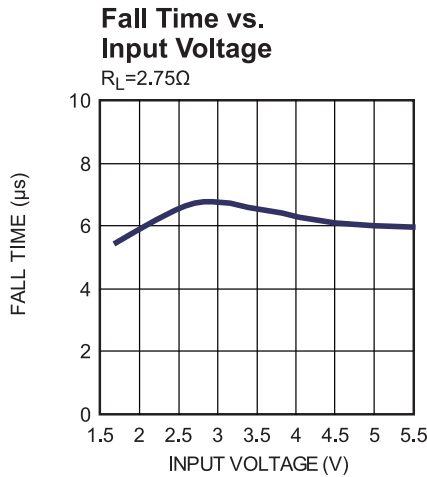
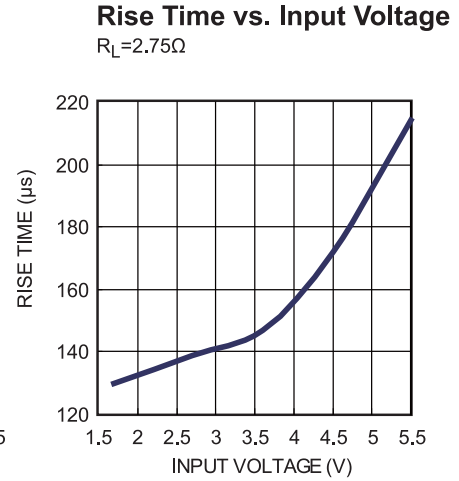
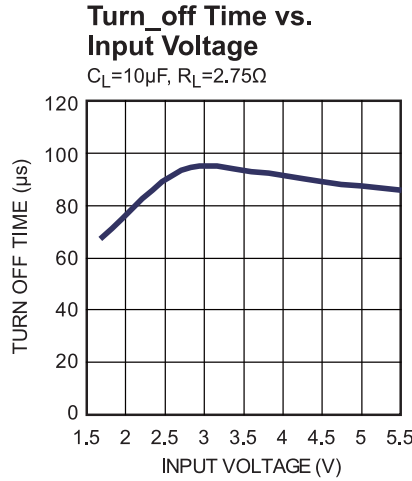
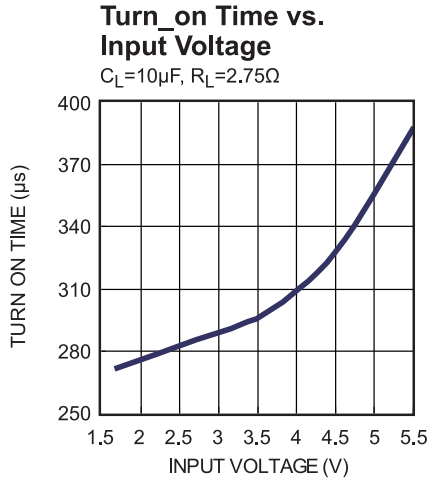

**TYPICAL PERFORMANCE CHARACTERISTICS** *(continued)*
 $V_{IN} = V_{EN} = 3.6V$ ,  $C_L = 1\mu F$ ,  $T_A = +25^\circ C$ , unless otherwise noted.

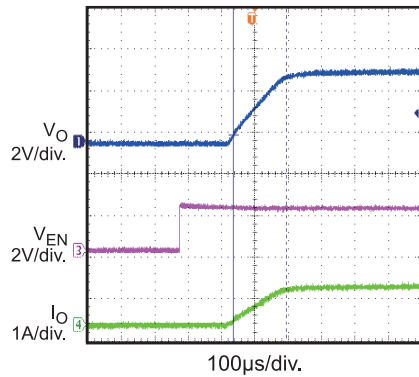
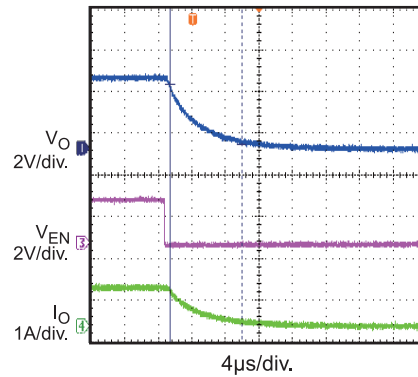
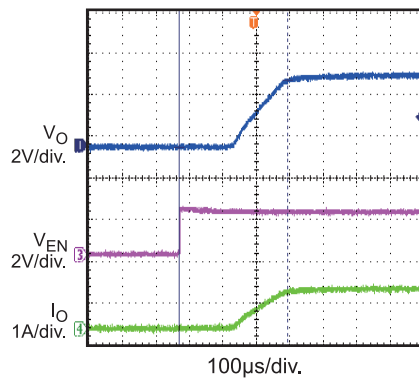
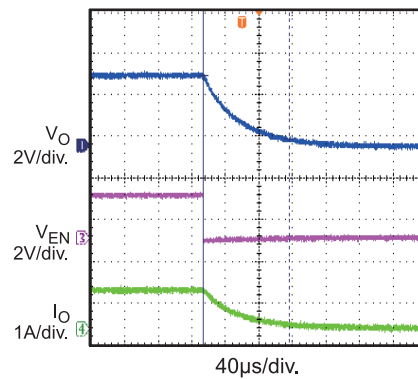
**Turn\_on Delay and Rise Time  
with 1 $\mu F$  Load**  
 $R_L = 3.6\Omega$ 

**Turn\_off Delay and Fall Time  
with 1 $\mu F$  Load**  
 $R_L = 3.6\Omega$ 

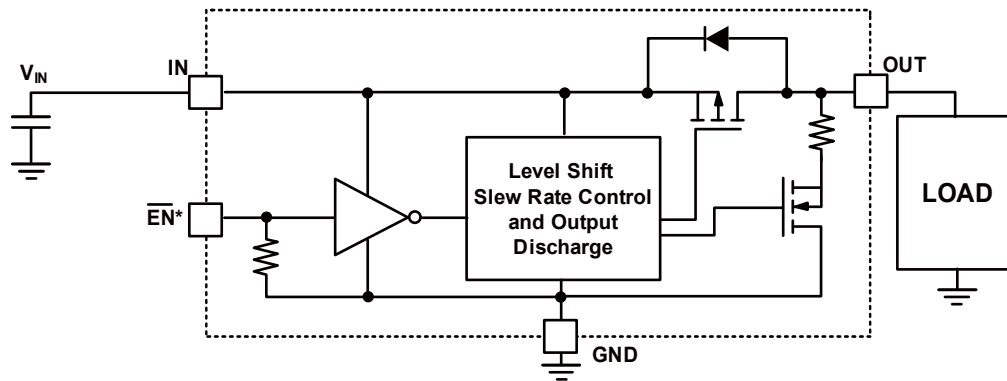
**Turn\_on Delay and Rise Time  
with 10 $\mu F$  Load**  
 $C_{OUT} = 10\mu F$ ,  $R_L = 3.6\Omega$ 

**Turn\_off Delay and Fall Time  
with 10 $\mu F$  Load**  
 $C_{OUT} = 10\mu F$ ,  $R_L = 3.6\Omega$ 

## FUNCTION BLOCK DIAGRAM



(\*: EN is active high for MP62041-1)

**Figure 2—Function Block Diagram**

## DETAILED DESCRIPTION

The MP62040-1/MP62041-1 Power Distribution Switch is designed for high-side load switch. The switch operates from 1.7V to 5.5V nominal input voltage and can handle up to 2A continuous load.

### Enable

The logic pin disables the switch to reduce overall supply current. Once the EN pin reaches logic enable threshold, the MP62040-1/MP62041-1 is enabled and the supply current is very small, only 2 $\mu$ A.

### Output Discharge

The part includes a discharge function that provides a resistive discharge path for the external output capacitor. This function allows the device to quickly discharge the output voltage when it's disabled.

## APPLICATION INFORMATION

### Power-Supply Considerations

Over 10 $\mu$ F capacitor between IN and GND is recommended. This precaution reduces power-supply transients that may cause ringing on the input.

In order to achieve smaller output load transient ripple, placing a high-value electrolytic capacitor on the output pin(s) is recommended when the load is heavy.

## PACKAGE INFORMATION

### UTQFN (1.6x1.2mm)

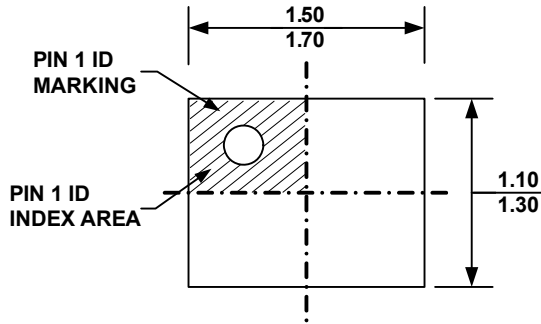

**TOP VIEW**

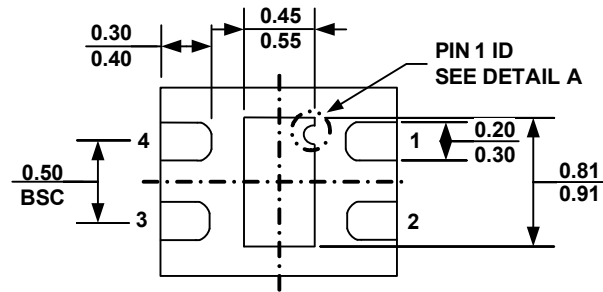

**BOTTOM VIEW**

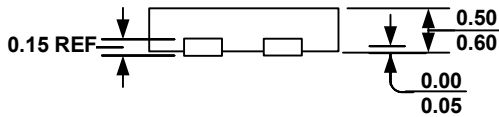

**SIDE VIEW**

**PIN 1 ID OPTION A**  
R 0.10 TYP.

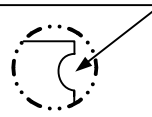

**PIN 1 ID OPTION B**  
0.20x45° TYP.

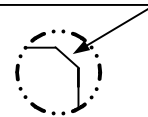

**DETAIL A**

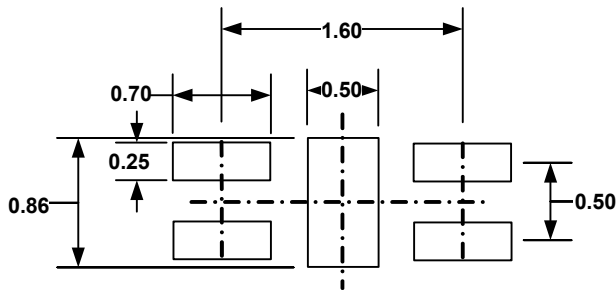

**RECOMMENDED LAND PATTERN**

#### NOTE:

- 1) ALL DIMENSIONS ARE IN MILLIMETERS
- 2) EXPOSED PADDLE SIZE DOES NOT INCLUDE MOLD FLASH
- 3) LEAD COPLANARITY SHALL BE 0.10 MILLIMETER MAX
- 4) JEDEC REFERENCE IS MO-229.
- 5) DRAWING IS NOT TO SCALE

**NOTICE:** The information in this document is subject to change without notice. Users should warrant and guarantee that third party Intellectual Property rights are not infringed upon when integrating MPS products into any application. MPS will not assume any legal responsibility for any said applications.