

DESCRIPTION

The MP3307 is a non-synchronous WLED step-up driver with a 2.7V to 5.5V input range. It uses peak current mode to regulate the LED current sensed through an external low-side resistor.

The MP3307 features up to 2.2MHz of programmable switching frequency, making it easy to avoid noise interference, optimize efficiency, and reduce the output filter component size. To extend the dimming range, both analog and PWM dimming modes are supported with a separate input.

The MP3307 has LED open protection, output over-voltage protection, cycle-by-cycle current-limit protection, and thermal shutdown protection.

The MP3307 is available in a TSOT23-8 package, which is ideal for use in video displays.

FEATURES

- 2.7V to 5.5V Input Voltage
- Analog Dimming with >20kHz Input Signal
- Direct PWM Dimming Mode with 100Hz to 2kHz Input Signal
- Up to 2.2MHz Programmable Switching Frequency
- Low 200mV Feedback Voltage with $\pm 1\%$ Accuracy at Room Temperature
- 24V Open-Load Protection Threshold
- UVLO and Thermal Shutdown
- Cycle-by-Cycle Over-Current Protection
- Available in a TSOT23-8 Package

APPLICATIONS

- Video Displays
- In-Car LCD Infotainment
- Tablets

All MPS parts are lead-free, halogen-free, and adhere to the RoHS directive. For MPS green status, please visit the MPS website under Quality Assurance. "MPS" and "The Future of Analog IC Technology" are registered trademarks of Monolithic Power Systems, Inc.

TYPICAL APPLICATION

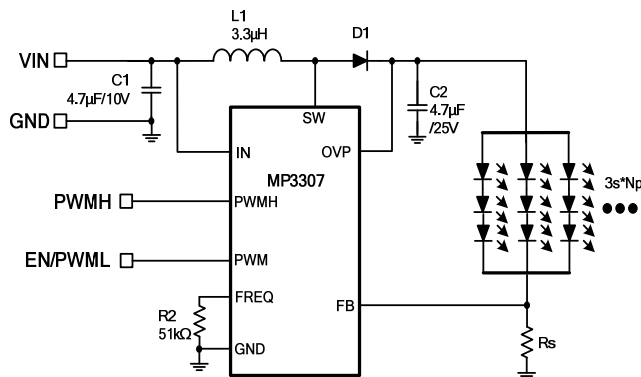

Efficiency vs. V_{IN}

3S4P, $F_{SW}=1.2\text{MHz}$,
inductor: 3.3µH/65mΩ

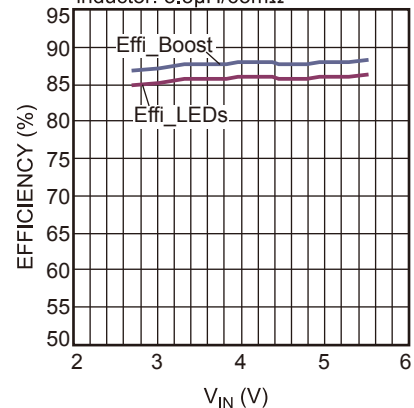

ORDERING INFORMATION

Part Number*	Package	Top Marking
MP3307GJ	TSOT23-8	<i>See Below</i>

* For Tape & Reel, add suffix –Z (e.g. MP3307GJ–Z)

TOP MARKING

| ANFY

ANF: Product code of MP3307GJ
Y: Year code

PACKAGE REFERENCE

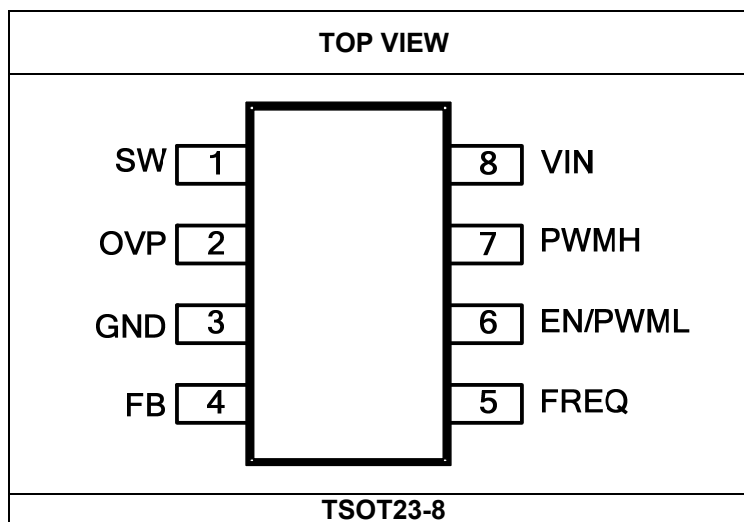

ABSOLUTE MAXIMUM RATINGS ⁽¹⁾

V_{IN}	–0.3V to +6V
V_{SW} , V_{OUT}	–1V to +40V
All other pins	–0.3V to +6V
Junction temperature	150°C
Lead temperature	260°C
Continuous power dissipation	($T_A = 25^\circ\text{C}$) ⁽²⁾
TSOT23-8	1.25W

Recommended Operating Conditions ⁽³⁾

Supply voltage (V_{IN})	2.7V to 5.5V
Operating junction temp. (T_J)...	–40°C to +125°C

Thermal Resistance ⁽⁴⁾	θ_{JA}	θ_{JC}
TSOT23-8	100.....	55 °C/W

NOTES:

- 1) Exceeding these ratings may damage the device.
- 2) The maximum allowable power dissipation is a function of the maximum junction temperature T_J (MAX), the junction-to-ambient thermal resistance θ_{JA} , and the ambient temperature T_A . The maximum allowable continuous power dissipation at any ambient temperature is calculated by P_D (MAX) = $(T_J$ (MAX)– T_A)/ θ_{JA} . Exceeding the maximum allowable power dissipation will cause an excessive die temperature, causing the regulator to go into thermal shutdown. Internal thermal shutdown circuitry protects the device from permanent damage.
- 3) The device is not guaranteed to function outside of its operating conditions.
- 4) Measured on JESD51-7, 4-layer PCB.

ELECTRICAL CHARACTERISTICS

$V_{IN} = 3.6V$, $V_{EN} = V_{IN}$, $T_A = 25^{\circ}C$, unless otherwise noted.

Parameters	Symbol	Condition	Min	Typ	Max	Units
Step-Up Converter						
Operating input voltage	V_{IN}		2.7		5.5	V
Supply current (quiescent)	I_Q	No load with switching		440		μA
Supply current (shutdown)	I_{ST}	$V_{EN} = 0V$, $V_{IN} = 3.6V$			1	μA
Input UVLO threshold	V_{IN_UVLO}	Rising edge		2.5		V
Input UVLO hysteresis				200		mV
EN high voltage	V_{EN_HIGH}	V_{EN} rising	1.2			V
EN low voltage	V_{EN_LOW}	V_{EN} falling			0.4	V
Switching frequency	f_{SW}	$R_{OSC} = 51k\Omega$		2.22		MHz
Maximum duty cycle	D_{MAX}		90	93		%
Feedback regulation voltage	V_{REF}		198	200	202	mV
V_{REF} ramp-up time per step	t_{STEP}			320		μs
Power Switch						
Main switch on resistance	R_{DSON_M}	$V_{IN} = 3.6V$		0.3	0.5	Ω
Current Dimming						
PWMH input low threshold	V_{PWM_LO}	V_{PWM} falling			0.4	V
PWMH input high threshold	V_{PWM_HI}	V_{PWM} rising	1.2			V
PWML shutdown time	t_{SD}	EN/PWML high to low		20		ms
Protection						
OVP voltage	V_{OVP}	OVP	22.5	24	25.5	V
		Hysteresis		2		V
Cycle-by-cycle current limit	I_{LIM}		1.6			A
OVP UVLO threshold	V_{OVP_UV}			1.25		V
Thermal shutdown threshold	t_{ST}			150		$^{\circ}C$
Thermal shutdown hysteresis				25		$^{\circ}C$

TYPICAL PERFORMANCE CHARACTERISTICS

$V_{IN} = 3.6V$, 3s*4p LEDs, $L = 3.3\mu H$, $f_s = 2.2MHz$, $T_A = 25^\circ C$, unless otherwise noted.

PWM Dimming Curve

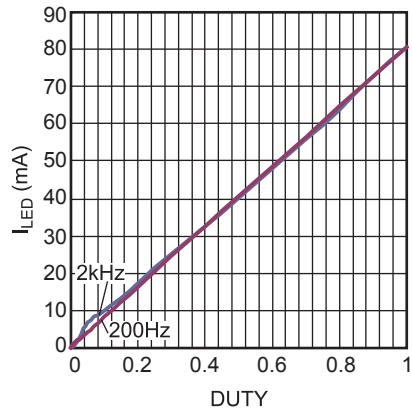

Analog Dimming Curve

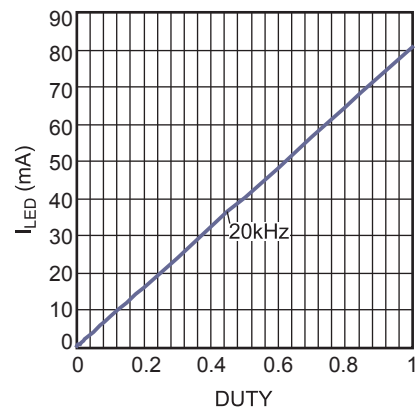

TYPICAL PERFORMANCE CHARACTERISTICS (continued)
 $V_{IN} = 3.6V$, 3s*4p LEDs, $L = 3.3\mu H$, $f_s = 2.2MHz$, $T_A = 25^\circ C$, unless otherwise noted.

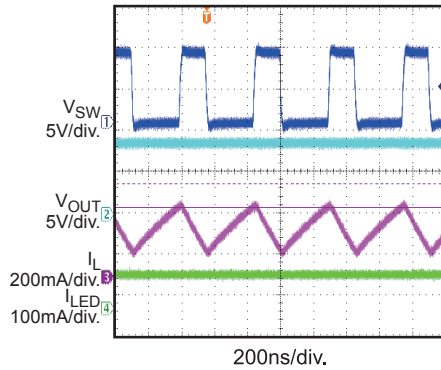
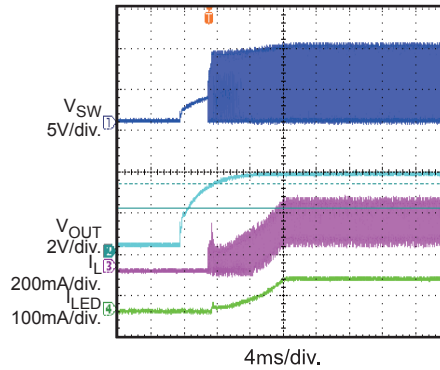
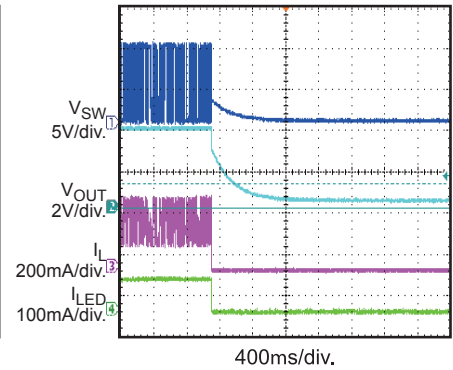
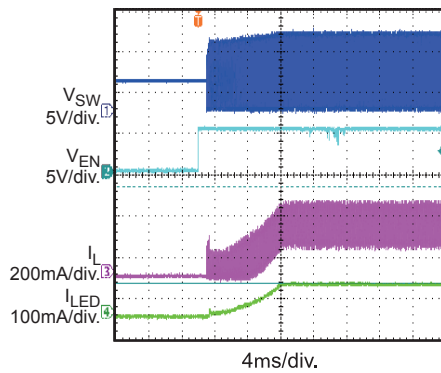
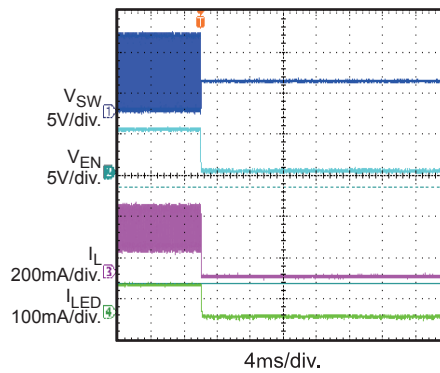
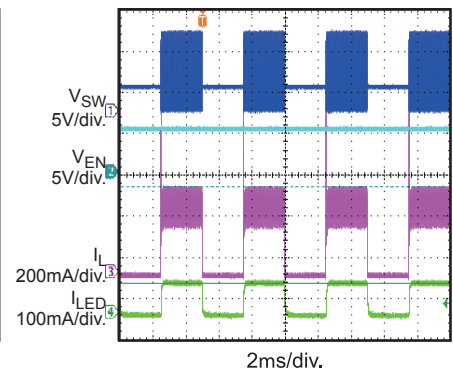
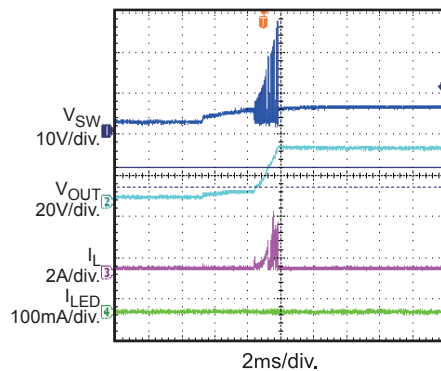
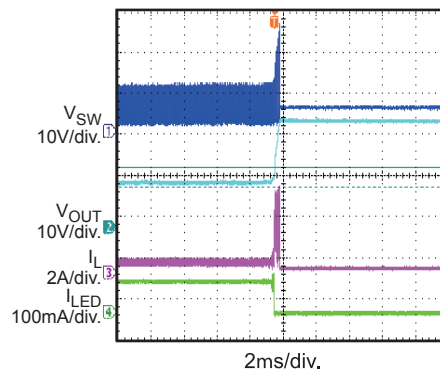
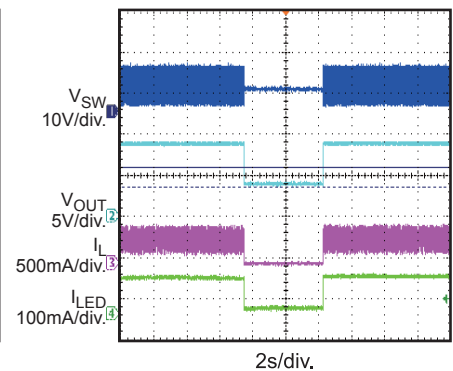
Steady State

 V_{IN} Power On

 V_{IN} Power Off

EN Power On

EN Power Off

PWM Dimming
 $F_{PWM} = 200Hz$, $D = 50\%$

Start-Up in Open Load

Open Load in Normal Operation

Thermal Shutdown then Recover

PIN FUNCTIONS

Pin #	Name	Description
1	SW	Power switch node. SW is the drain of the internal low-side MOSFET. Connect the power inductor between SW and V_{IN} .
2	OVP	Over-voltage sensing.
3	GND	Ground.
4	FB	LED current feedback. FB regulates the voltage across the current-sense resistor between FB and GND to 200mV.
5	FREQ	Switching frequency set. Connect a resistor between FREQ and GND to program the converter switching frequency. Do NOT leave FREQ floating.
6	EN/PWML	PWM brightness control/enable. Apply a PWM signal for PWM dimming. The PWM frequency is proportional to the LED current dimming ratio—a lower dimming frequency results in a smaller dimming current. For most applications, use a frequency range of 200Hz to 2kHz. A low-level signal longer than 20ms will shut down the IC.
7	PWMH	Analog dimming input. A >20kHz PWM signal is recommended if a PWM signal input is being used for analog dimming.
8	VIN	Input supply. VIN provides power for internal power and the logic circuits. VIN must be bypassed locally.

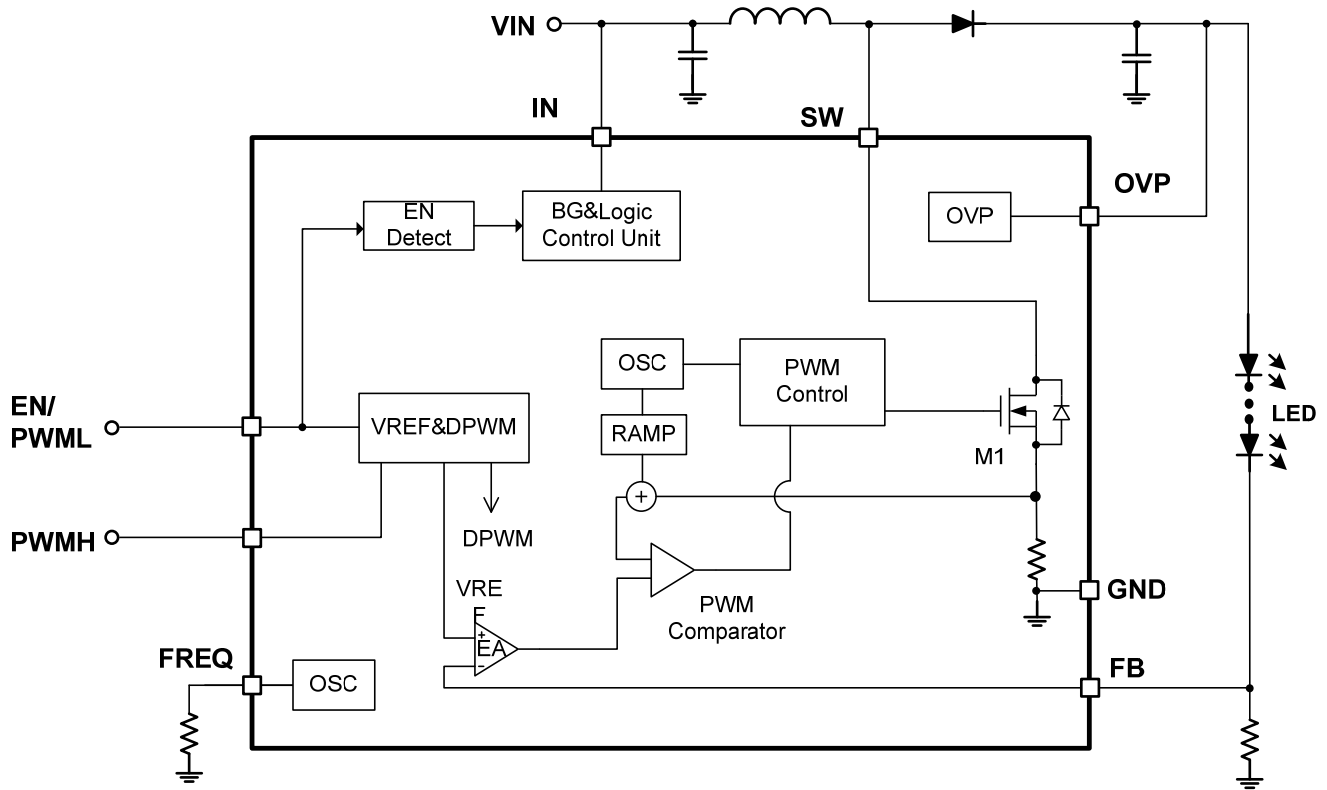

Figure 1: Functional Block Diagram

OPERATION

The MP3307 uses peak-current-mode control to regulate the current through the WLED string. At the start of each oscillator cycle, the control circuit turns on the low-side MOSFET (LS-FET, M1). A stabilizing ramp is added to the output of the current sense amplifier, which feeds into the positive input of the PWM comparator and prevents sub-harmonic oscillations at duty cycles greater than 50%. When the input of the PWM comparator equals the output voltage of the error amplifier, M1 turns off. The inductor current then flows through the external Schottky diode, which forces the inductor current to decrease.

The voltage at the output of the error amplifier is the amplified difference between the 200mV reference voltage and the feedback voltage. If the feedback voltage starts to drop, the output of the error amplifier increases. This also increases the current flowing through M1, the power to the inductor, and the output power. This method regulates the LED current accurately.

System Start-Up

When enabled, the MP3307 checks safety limits, including UVLO, over-temperature protection (OTP), and over-current protection (OCP). If all of the protection tests pass, the chip then boosts the step-up converter with an internal soft start. During the soft start, the current reference increases from 0 to 200mV in 32 steps (320μs per step) to prevent a large inrush current.

Dimming Control

The MP3307 provides two dimming methods: PWM dimming and analog dimming mode.

For PWM dimming, apply a PWM signal to EN/PWML. The LED current is then segmented according to the PWM signal and the average LED current. See Equation (1):

$$I_{\text{set}} \times D_{\text{dim}} \quad (1)$$

Where D_{dim} is the PWM duty cycle, and I_{set} is the LED current amplitude.

When the PWM signal is high, the converter operates in normal mode. Conversely, when the PWM amplitude is low, the converter stops switching. If the PWM signal low-level time is more than 20ms, the IC shuts down. Use a 100Hz to 2kHz PWM dimming frequency for most dimming ratio requests.

For analog dimming, connect the PWM dimming signal to PWMH. An internal RC filter filters the PWM signal. The LED current amplitude equals $I_{\text{set}} \times D_{\text{dim}}$, where D_{dim} is the PWM duty cycle, and I_{set} is the LED current amplitude. Use a >20kHz PWM signal to improve filtering performance.

Open-String Protection

The MP3307 monitors V_{OUT} for open-string protection. If the LED string is open, the feedback voltage is lower than the reference voltage. The COMP then rises and charges the output capacitor until the V_{OUT} reaches the protection point (V_{OVP}).

The IC stops switching when V_{OUT} reaches the OVP threshold; it resumes operation when V_{OUT} drops below the threshold.

Input Under-Voltage Protection

When V_{IN} exceeds 2.5V, the converter starts to charge the internal reference and provides power to the internal control circuitry. There is an UVLO hysteresis (approximately 200mV) as V_{IN} falls. The IC shuts down when the input voltage drops below 2.3V.

Thermal Shutdown Protection

Thermal shutdown prevents the IC from operating at exceedingly high temperatures. When the die temperature exceeds the upper threshold (T_{ST}), the IC shuts down; it resumes normal operation when the die temperature drops below the lower threshold. Typically, the hysteresis is 25°C.

APPLICATION INFORMATION

Selecting the Switching Frequency

The switching frequency of the step-up converter can be programmed from 300kHz to 1.2MHz. A resistor on OSC sets the internal oscillator frequency for the step-up converter with Equation (2):

$$f_{sw}(\text{kHz}) = \frac{120000}{R_{OSC}(\text{k}\Omega)} \quad (2)$$

For instance, if $R_{OSC}=51\text{k}\Omega$, then the switching frequency is 2.35MHz.

Setting the LED Current

Set the LED current through the current-setting resistor on FB using Equation (3):

$$I_{LED}(\text{mA}) = \frac{V_{REF}(\text{V})}{R_{FB}(\Omega)} \times 1000 \quad (3)$$

For instance, if $V_{REF}=200\text{mV}$, and $R_{FB}=10\Omega$, then the LED current is 20mA. Do NOT leave FB floating.

Selecting the Input Capacitor

The input capacitor reduces the surge current drawn from the input supply and the switching noise from the device. The input capacitor impedance at the switching frequency should be less than the input source impedance to prevent the high-frequency switching current from passing through to the input. Use ceramic capacitors with X5R or X7R dielectrics for their low ESR and small temperature coefficients. For most applications, use a 2.2 μF to 10 μF ceramic capacitor.

Selecting the Inductor

The MP3307 requires an inductor to boost its output voltage. An inductor with a larger value results in less ripple current; it also lowers both the peak inductor current and stress on the internal N-channel MOSFET. However, the larger inductor is physically larger and has both a higher series resistance and a lower saturation current.

Choose an inductor that does not saturate under the worst-case load conditions. Select a minimum inductor value to ensure that the boost converter works in continuous conduction

mode with high efficiency and good EMI performance.

Calculate the required inductance value using Equation (4) and Equation (5):

$$L \geq \frac{\eta \times V_{OUT} \times D \times (1-D)^2}{2 \times f_{sw} \times I_{LOAD}} \quad (4)$$

$$D = 1 - \frac{V_{IN}}{V_{OUT}} \quad (5)$$

Where V_{IN} and V_{OUT} are the input and output voltages, f_{sw} is the switching frequency, I_{LOAD} is the LED load current, and η is the efficiency.

To avoid hitting the switching current limit for peak current mode, the worst-case inductor peak current should be less than 80% of the current limit (I_{LIM}).

Selecting the Output Capacitor

The output capacitor keeps the output voltage ripple small and ensures feedback loop stability. The output capacitor impedance must be low at the switching frequency. Ceramic capacitors with X7R dielectrics are recommended for their low ESR characteristics. Selection must also account for the capacitance's dependence on the voltage rating. With DC bias voltage, the capacitor can lose as much as 50% of its capacitance at its rated voltage rating. Leave a sufficient voltage rating margin when selecting the component.

A capacitance that is too low or too high causes loop instability. For most applications, select a capacitor in the range of 2.2 μF to 10 μF .

PCB Layout Guidelines

Efficient PCB layout is critical for preventing noise, limiting electromagnetic interference, and achieving stable operation. For best results, refer to Figure 2 and follow the guidelines below:

1. Minimize the loop consisting of the MP3307's internal low-side MOSFET, external Schottky diode, and output capacitor, as it contains a high-frequency ripple current.
2. Place the input and output capacitors as close to the IC as possible.

TYPICAL APPLICATION CIRCUITS

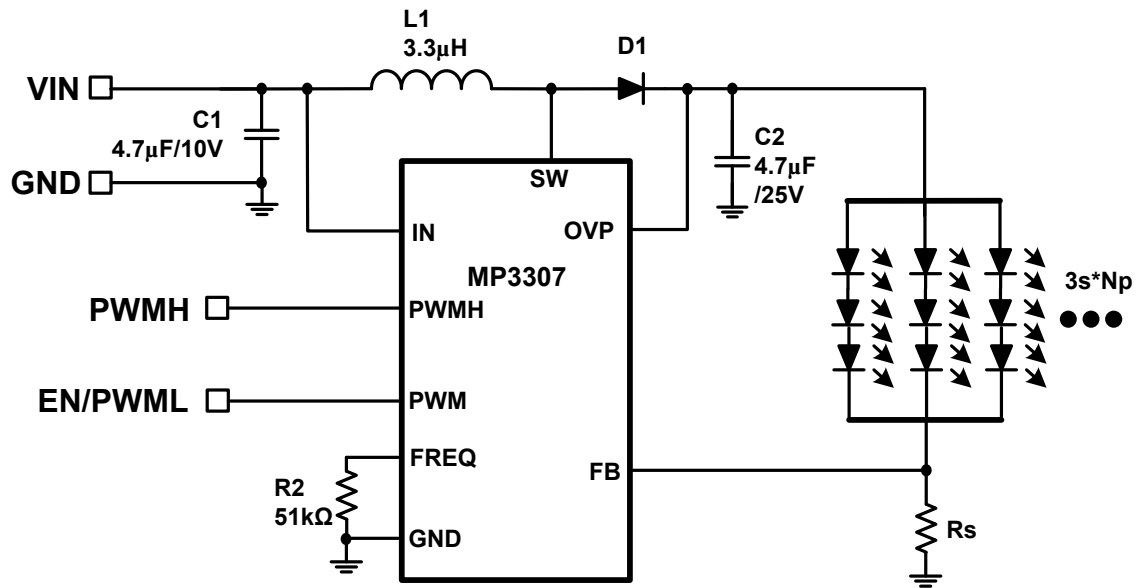
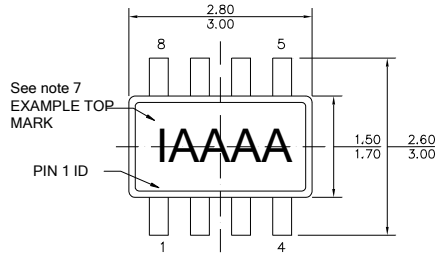

Figure 2: Typical Application for 3s*Np LEDs

PACKAGE INFORMATION

TSOT23-8



TOP VIEW

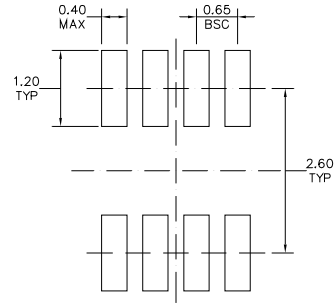

RECOMMENDED LAND PATTERN

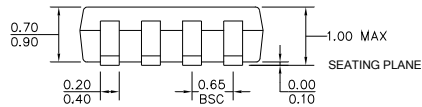

FRONT VIEW

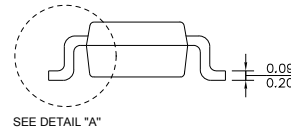

SIDE VIEW

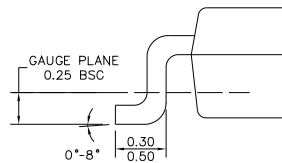

DETAIL "A"

NOTE:

- 1) ALL DIMENSIONS ARE IN MILLIMETERS.
- 2) PACKAGE LENGTH DOES NOT INCLUDE MOLD FLASH, PROTRUSION OR GATE BURR.
- 3) PACKAGE WIDTH DOES NOT INCLUDE INTERLEAD FLASH OR PROTRUSION.
- 4) LEAD COPLANARITY (BOTTOM OF LEADS AFTER FORMING) SHALL BE 0.10 MILLIMETERS MAX.
- 5) JEDEC REFERENCE IS MO-193, VARIATION BA.
- 6) DRAWING IS NOT TO SCALE.
- 7) PIN 1 IS LOWER LEFT PIN WHEN READING TOP MARK FROM LEFT TO RIGHT, (SEE EXAMPLE TOP MARK)

NOTICE: The information in this document is subject to change without notice. Please contact MPS for current specifications. Users should warrant and guarantee that third party Intellectual Property rights are not infringed upon when integrating MPS products into any application. MPS will not assume any legal responsibility for any said applications.