

DESCRIPTION

The MP2160 is a monolithic step-down switch mode converter with built-in internal power MOSFETs. It achieves 1.2A peak continuous output current from a 2.7V to 6V input voltage with excellent load and line regulation. The output voltage can be regulated as low as 0.6V.

The Constant-On-Time control scheme provides fast transient response and eases loop stabilization. Fault condition protection includes cycle-by-cycle current limiting and thermal shutdown.

The MP2160 is available in the small QFN8 1.5x2.0mm package and requires a minimum number of readily available standard external components.

The MP2160 is ideal for a wide range of applications including High Performance DSPs, FPGAs, PDAs, portable instruments and DVD drivers.

FEATURES

- Wide 2.7V to 6V Operating Input Range
Output Adjustable from 0.6V
- Up to 1.2A Peak Output Current
- 100% Duty Cycle in Dropout
- Low IQ: 17 μ A
- 100m Ω and 60m Ω Internal Power MOSFET Switches
- Default 3.5MHz Switching Frequency
- EN and Power Good for Power Sequencing
- Cycle-by-Cycle Over Current Protection
- Short Circuit Protect with Hiccup Mode
- Stable with Low ESR Output Ceramic Capacitors
- Available in a QFN8 1.5x2.0mm Package

APPLICATIONS

- Wireless Card
- DVD Drivers

All MPS parts are lead-free, halogen free, and adhere to the RoHS directive. For MPS green status, please visit MPS website under Quality Assurance. "MPS" and "The Future of Analog IC Technology" are Registered Trademarks of Monolithic Power Systems, Inc.

TYPICAL APPLICATION

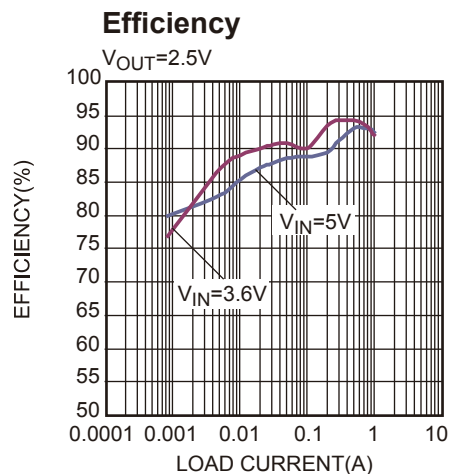
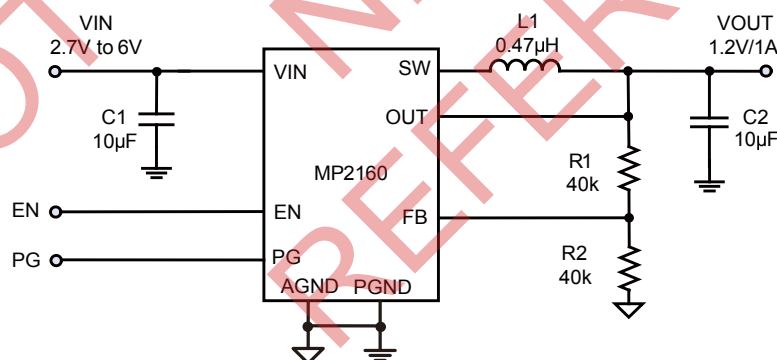

ORDERING INFORMATION

Part Number*	Package	Top Marking
MP2160GQH	QFN8 (1.5x2.0mm)	BC

* For Tape & Reel, add suffix -Z (e.g. MP2160GQH-Z);

TOP MARKING

—
BC
LL

BC: product code of MP2160GQH;
LL: lot number;

PACKAGE REFERENCE

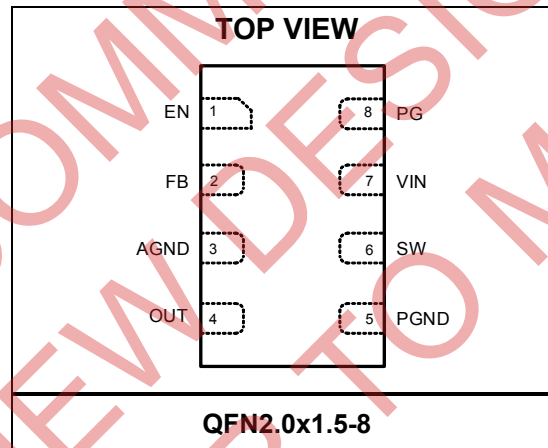

ABSOLUTE MAXIMUM RATINGS ⁽¹⁾

Supply Voltage V_{IN}	6.5V
V_{SW}	-0.3V (-1.5V for <20ns & -4V for <8ns) to 6.5V (10V for <10ns)
All Other Pins	-0.3V to 6.5 V
Continuous Power Dissipation ($T_A = +25^\circ\text{C}$) ⁽²⁾	1.14W
Junction Temperature	150°C
Lead Temperature	260°C
Storage Temperature	-65°C to +150°C

Recommended Operating Conditions ⁽³⁾

Supply Voltage V_{IN}	2.7V to 6V
Operating Junction Temp. (T_J)	-40°C to +125°C

Thermal Resistance ⁽⁴⁾	θ_{JA}	θ_{JC}
QFN8 (1.5x2.0mm)	110	55... °C/W

Notes:

- Exceeding these ratings may damage the device.
- The maximum allowable power dissipation is a function of the maximum junction temperature T_J (MAX), the junction-to-ambient thermal resistance θ_{JA} , and the ambient temperature T_A . The maximum allowable continuous power dissipation at any ambient temperature is calculated by P_D (MAX) = $(T_J$ (MAX) - T_A) / θ_{JA} . Exceeding the maximum allowable power dissipation will cause excessive die temperature, and the regulator will go into thermal shutdown. Internal thermal shutdown circuitry protects the device from permanent damage.
- The device is not guaranteed to function outside of its operating conditions.
- Measured on JESD51-7, 4-layer PCB.

ELECTRICAL CHARACTERISTICS

$V_{IN} = 5V$, $T_A = +25^{\circ}C$, unless otherwise noted.

Parameter	Symbol	Condition	Min	Typ	Max	Units
Feedback Voltage	V_{FB}	$2.7V \leq V_{IN} \leq 6V$	-2%	0.600	+2%	V/%
		$T_A = -40^{\circ}C$ to $+85^{\circ}C^{(6)}$	-2.5%		+2.5%	
Feedback Current	I_{FB}	$V_{FB} = 0.6V$		10	50	nA
PFET Switch On Resistance	R_{DSON_P}			100		m Ω
NFET Switch On Resistance	R_{DSON_N}			60		m Ω
Switch Leakage		$V_{EN} = 0V$, $V_{IN} = 6V$ $V_{SW} = 0V$ and $6V$		0	1	μA
PFET Current Limit		40% duty cycle	1.6	2.1	2.6	A
ON Time	T_{ON}	$V_{IN}=5V$, $V_{OUT}=1.2V$		70		ns
		$V_{IN}=3.6V$, $V_{OUT}=1.2V$		100		
Switching frequency	F_s	$V_{OUT}=1.2V$, $V_{IN}=3.6V$	-20%	3500	+20%	kHz/%
		$T_A = -40^{\circ}C$ to $+85^{\circ}C^{(6)}$	-25%	3500	+25%	
Minimum Off Time	$T_{MIN-OFF}$			60		ns
Soft-Start Time	T_{SS-ON}			1.5		ms
Power Good Upper Trip Threshold	PG_H	FB voltage respect to the regulation		+10		%
Power Good Lower Trip Threshold	PG_L			-10		%
Power Good Delay	PG_D			50		μs
Power Good Sink Current Capability	V_{PG-L}	Sink 1mA			0.4	V
Power Good Logic High Voltage	V_{PG-H}	$V_{IN}=5V$, $V_{FB}=0.6V$	4.9			V
Power Good Internal Pull Up Resistor	R_{PG}			550		k Ω
Under Voltage Lockout Threshold Rising			2.15	2.3	2.45	V
Under Voltage Lockout Threshold Hysteresis				300		mV
EN Input Logic Low Voltage					0.4	V
EN Input Logic High Voltage			1.2			V
EN Input Current		$V_{EN}=2V$		1.5		μA
		$V_{EN}=0V$		0.1	1	μA
Supply Current (Shutdown)		$V_{EN}=0V$		0.1		μA
Supply Current (Quiescent)		$V_{EN}=2V$, $V_{FB}=0.63V$, $V_{IN}=5V$		17	20	μA
Thermal Shutdown				150		$^{\circ}C$
Thermal Hysteresis ⁽⁵⁾				30		$^{\circ}C$

Notes:

- 5) Not production test, guaranteed by design.
- 6) Not production test, guaranteed by characterization.

TYPICAL CHARACTERISTICS

$V_{IN} = 5V$, $V_{OUT} = 1.2V$, $L = 0.47\mu H$, $T_A = +25^\circ C$, unless otherwise noted.

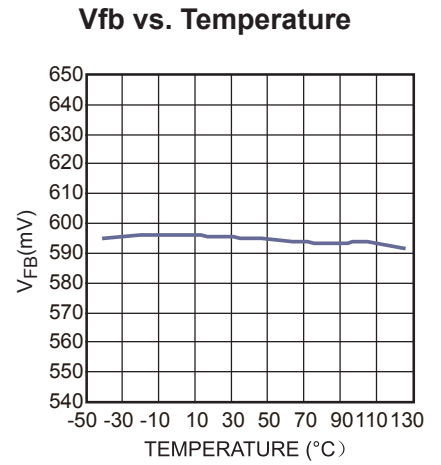
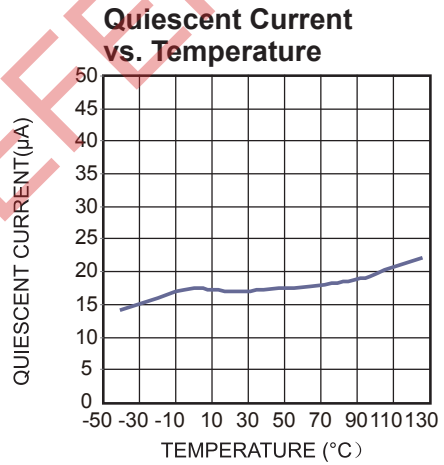
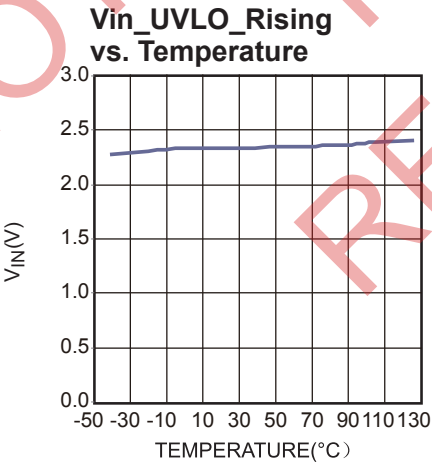
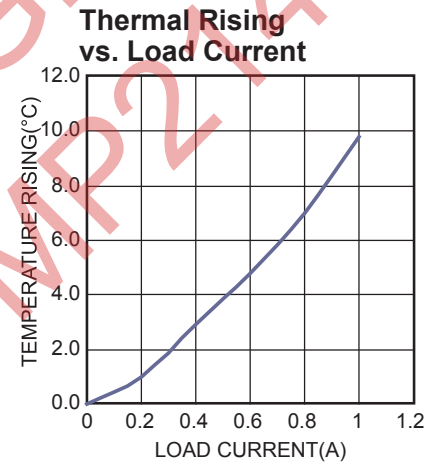
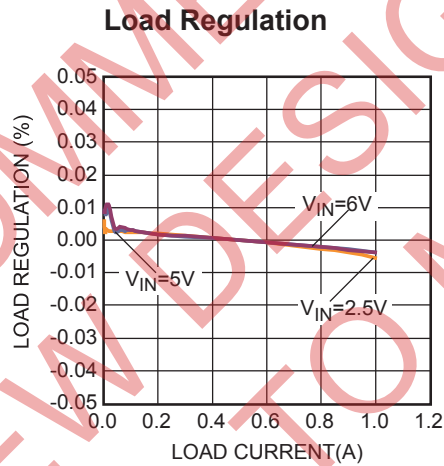
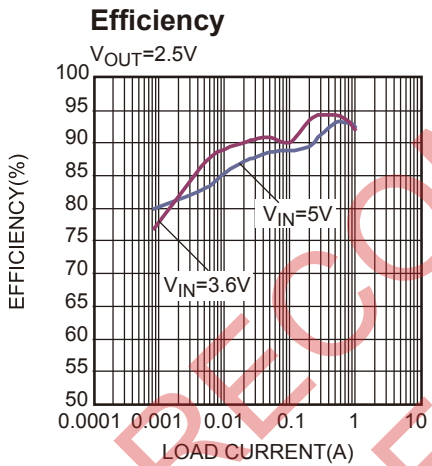
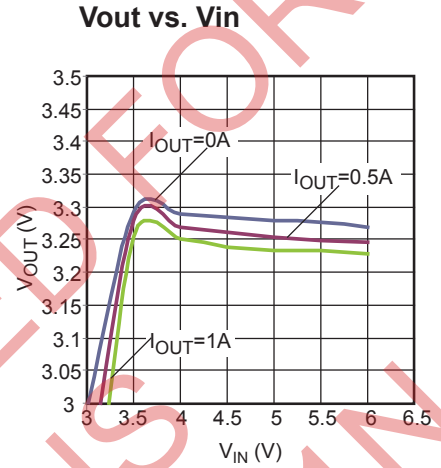
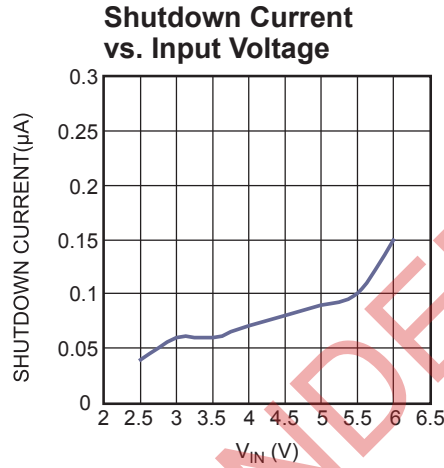
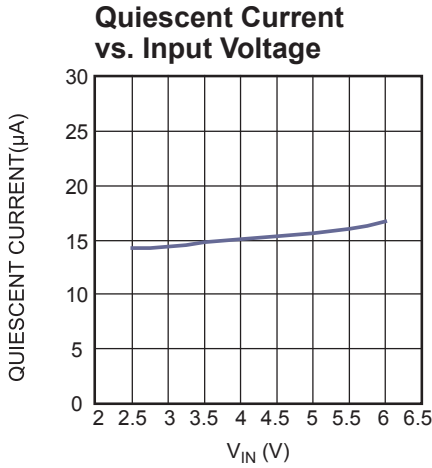

TYPICAL PERFORMANCE CHARACTERISTICS (continued)
 $V_{IN} = 5V$, $V_{OUT} = 1.2V$, $L = 0.47\mu H$, $T_A = +25^\circ C$, unless otherwise noted.

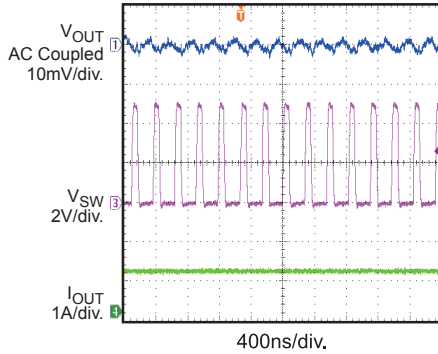
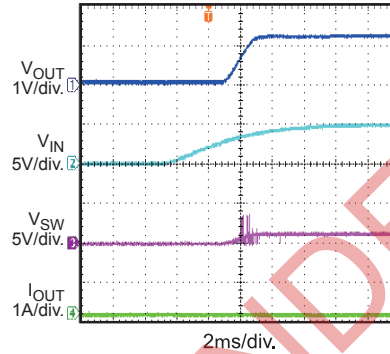
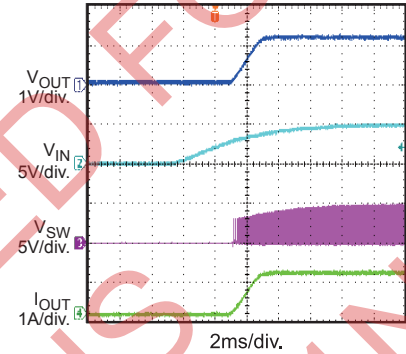
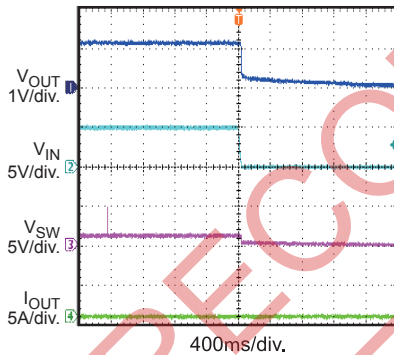
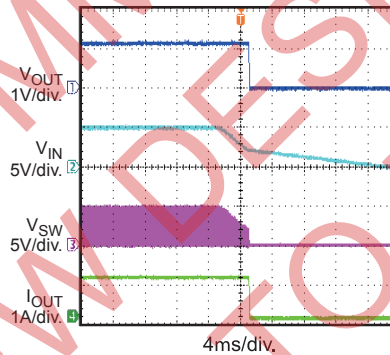
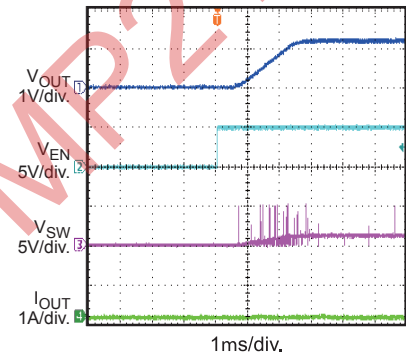
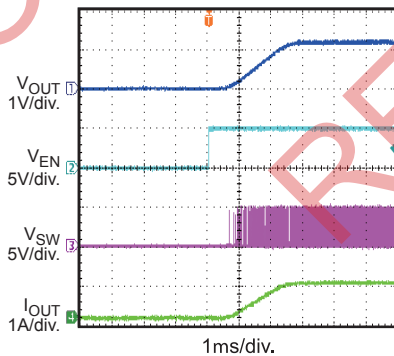
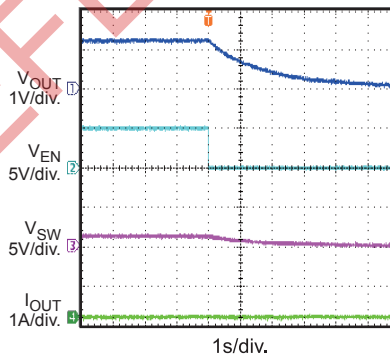
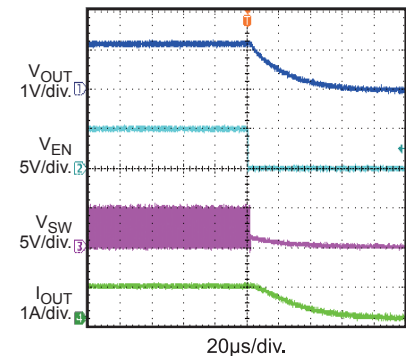
Output Ripple
 $I_{OUT} = 1A$

VIN Power Up without Load

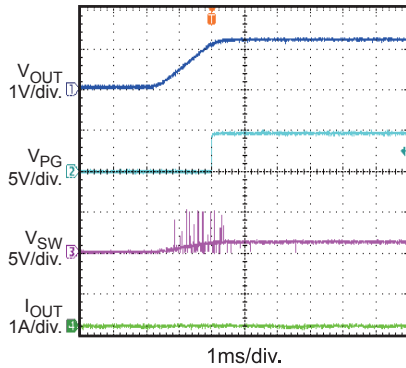
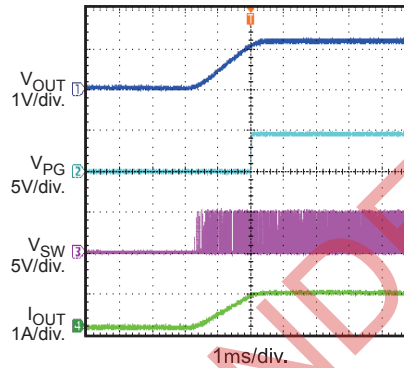
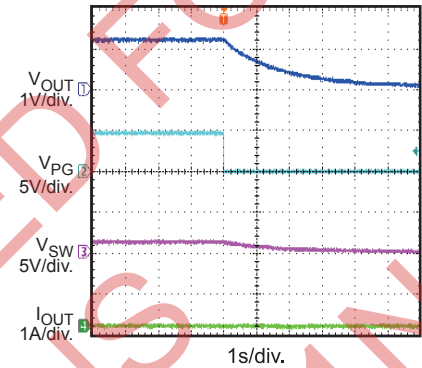
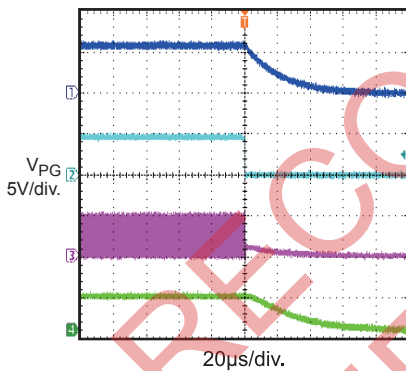
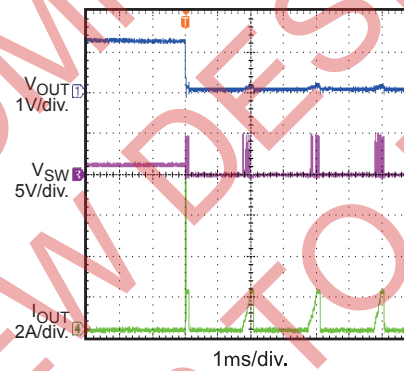
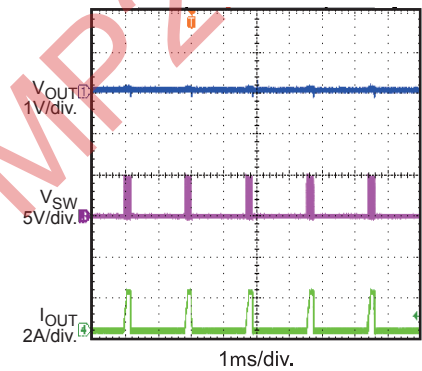
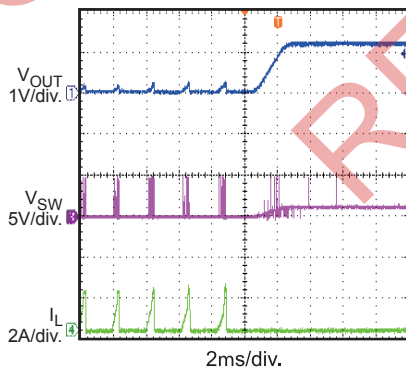
VIN Power Up with 1A Load

VIN Shut Down without Load

VIN Shut Down with 1A Load

EN Start Up without Load

EN Start Up with 1A Load

EN Shut Down without Load

EN Shut Down with 1A Load

TYPICAL PERFORMANCE CHARACTERISTICS (continued)
 $V_{IN} = 5V, V_{OUT} = 1.2V, L = 0.47\mu H, T_A = +25^\circ C$, unless otherwise noted.

Power Good On without Load

Power Good On with 1A Load

Power Good Off without Load

Power Good Off with 1A Load

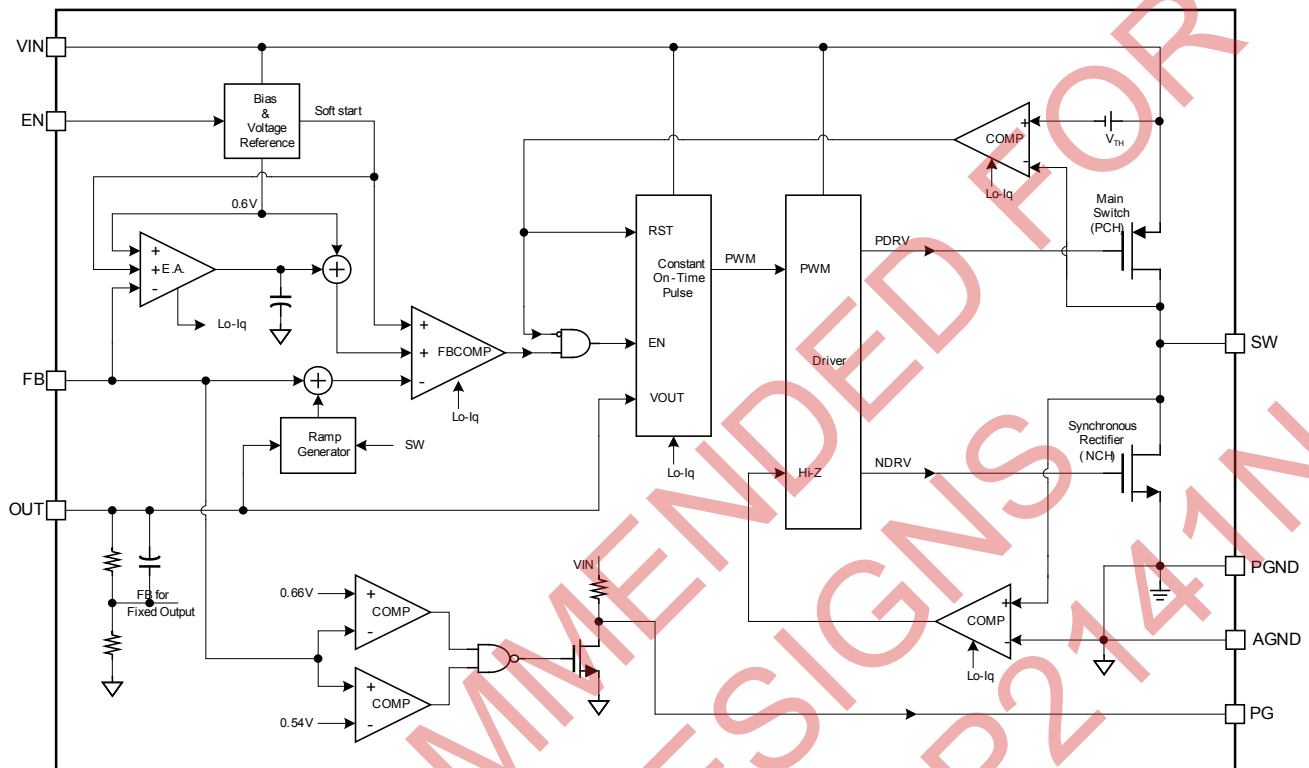
Short Circuit Entry

Short Circuit

Short Circuit Recovery

PIN FUNCTIONS

Pin #	Name	Description
1	EN	On/Off Control
2	FB	Feedback pin. An external resistor divider from the output to AGND, tapped to the FB pin, sets the output voltage.
3	AGND	Analogy ground for internal control circuit
4	OUT	Input sense pin for output voltage
5	PGND	Power ground
6	SW	Switch Output
7	VIN	Supply Voltage. The MP2160 operates from a +2.7V to +6V unregulated input. C1 is needed to prevent large voltage spikes from appearing at the input.
8	PG	Power Good Indicator. The output of this pin is an open drain with internal pull up resistor to VIN. PG is pulled up to VIN when the FB voltage is within $\pm 10\%$ of the regulation level, if FB voltage is out of that regulation range, it is LOW.

NOT RECOMMENDED FOR NEW DESIGN. REFER TO MP2141.

BLOCK DIAGRAM

Figure 1: MP2160 Block Diagram

OPERATION

MP2160 uses constant on-time control with input voltage feed forward to stabilize the switching frequency over full input range. At light load, MP2160 employs a proprietary control of low side switch and inductor current to eliminate ringing on switching node and improve efficiency.

Constant On-time Control

Compare to fixed frequency PWM control, constant on-time control offers the advantage of simpler control loop and faster transient response. By using input voltage feed forward, MP2160 maintains a nearly constant switching frequency across input and output voltage range. The on-time of the switching pulse can be estimated as:

$$T_{ON} = \frac{V_{OUT}}{V_{IN}} \cdot 0.285\mu s$$

To prevent inductor current run away during load transient, MP2160 fixes the minimum off time to be 30ns. However, this minimum off time limit will not affect operation of MP2160 in steady state in any way.

Light Load Operation

In light load condition, MP2160 uses a proprietary control scheme to save power and improve efficiency. The MP2160 will turn off the low side switch when inductor current starts to reverse. Then MP2160 works in discontinuous conduction mode (DCM) operation.

For COT part, the efficiency can be improved if using smaller inductor. That because smaller inductor can transfer more energy in single on pulse, and can save more driver loss.

Considering the internal circuit propagation time, the typical delay is 50ns. It means the inductor current still fall after the ZCD is trigger in this delay. If the inductor current falling slew rate is fast (VOUT voltage is high or close to Vin), the low side MOSFET is turned off and inductor current may be negative. This phenomena will cause MP2160 can not enter DCM operation. If the DCM mode is required, the off time of low side MOSFET in CCM should be longer than 100ns. For example, Vin is 3.6V and Vo is 3.3V, the off time in CCM is 60ns. It is difficult to enter

DCM at light load. And using smaller inductor can improve it and make it enter DCM easily.

Enable

When input voltage is greater than the under-voltage lockout threshold (UVLO), typically 2.3V, MP2160 can be enabled by pulling EN pin to higher than 1.2V. Leaving EN pin float or pull down to ground will disable MP2160. There is an internal 1Meg Ohm resistor from EN pin to ground.

Soft Start

MP2160 has built-in soft start that ramps up the output voltage in a controlled slew rate, avoiding overshoot at startup. The soft start time is about 1.5ms typical.

Power GOOD Indicator

MP2160 has an open drain with 550kΩ pull-up resistor pin for power good indicator PG. When FB pin is within +/-10% of regulation voltage, i.e. 0.6V, PG pin is pulled up to VIN by the internal resistor. If FB pin voltage is out of the +/-10% window, PG pin is pulled down to ground by an internal MOSFET. The MOSFET has a maximum R_{dson} of less than 100 Ohm.

Current limit

MP2160 has a typical 1.6A current limit for the high side switch. When the high side switch hits current limit, MP2160 will touch the hiccup threshold until the current lower down. This will prevent inductor current from continuing to build up which will result in damage of the components.

Short Circuit and Recovery

MP2160 enters short circuit protection mode also when the current limit is hit, and tries to recover from short circuit with hiccup mode. In short circuit protection, MP2160 will disable output power stage, discharge soft-start cap and then automatically try to soft-start again. If the short circuit condition still holds after soft-start ends, MP2160 repeats this operation cycle till short circuit disappears and output rises back to regulation level.

APPLICATION INFORMATION

COMPONENT SELECTION

Setting the Output Voltage

The external resistor divider is used to set the output voltage (see Typical Application on page 1). The feedback resistor R1 can not be too large neither too small considering the trade-off for stability and dynamic. Choose R1 to be around 40kΩ to 80kΩ. R2 is then given by:

$$R2 = \frac{R1}{\frac{V_{out}}{0.6} - 1}$$

The feedback circuit is shown as Figure 2.

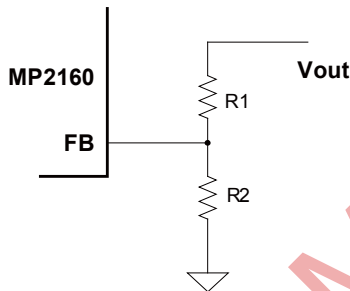

Figure 2: Feedback Network

Table 1 lists the recommended resistors value for common output voltages.

Table 1—Resistor Selection for Common Output Voltages

V _{OUT} (V)	R1 (kΩ)	R2 (kΩ)
1.0	40(1%)	60(1%)
1.2	40(1%)	40(1%)
1.8	60(1%)	30(1%)
2.5	80(1%)	25(1%)
3.3	80(1%)	17.7(1%)

Selecting the Inductor

A 0.15μH to 1μH inductor is recommended for most applications. For highest efficiency, the inductor DC resistance should be less than 15mΩ. For most designs, the inductance value can be derived from the following equation.

$$L_1 = \frac{V_{OUT} \times (V_{IN} - V_{OUT})}{V_{IN} \times \Delta I_L \times f_{OSC}}$$

Where ΔI_L is the inductor ripple current.

Choose inductor current to be approximately 30% of the maximum load current. The maximum inductor peak current is:

$$I_{L(MAX)} = I_{LOAD} + \frac{\Delta I_L}{2}$$

Selecting the Input Capacitor

The input current to the step-down converter is discontinuous, therefore a capacitor is required to supply the AC current to the step-down converter while maintaining the DC input voltage. Use low ESR capacitors for the best performance. Ceramic capacitors with X5R or X7R dielectrics are highly recommended because of their low ESR and small temperature coefficients. For most applications, a 10μF capacitor is sufficient. For higher output voltage, 22μF may be needed for more stable system.

Since the input capacitor absorbs the input switching current it requires an adequate ripple current rating. The RMS current in the input capacitor can be estimated by:

$$I_{C1} = I_{LOAD} \times \sqrt{\frac{V_{OUT}}{V_{IN}} \times \left(1 - \frac{V_{OUT}}{V_{IN}}\right)}$$

The worse case condition occurs at V_{IN} = 2V_{OUT}, where:

$$I_{C1} = \frac{I_{LOAD}}{2}$$

For simplification, choose the input capacitor whose RMS current rating greater than half of the maximum load current.

The input capacitor can be electrolytic, tantalum or ceramic. When using electrolytic or tantalum capacitors, a small and high quality ceramic capacitor, i.e. 0.1μF, should be placed as close to the IC as possible. When using ceramic capacitors, make sure that they have enough capacitance to provide sufficient charge to prevent excessive voltage ripple at input. The input voltage ripple caused by capacitance can be estimated by:

$$\Delta V_{IN} = \frac{I_{LOAD}}{f_s \times C1} \times \frac{V_{OUT}}{V_{IN}} \times \left(1 - \frac{V_{OUT}}{V_{IN}}\right)$$

Selecting the Output Capacitor

The output capacitor (C2) is required to maintain the DC output voltage. Ceramic capacitors are recommended. Low ESR capacitors are preferred to keep the output voltage ripple low. The output voltage ripple can be estimated by:

$$\Delta V_{OUT} = \frac{V_{OUT}}{f_s \times L_1} \times \left(1 - \frac{V_{OUT}}{V_{IN}} \right) \times \left(R_{ESR} + \frac{1}{8 \times f_s \times C2} \right)$$

Where L_1 is the inductor value and R_{ESR} is the equivalent series resistance (ESR) value of the output capacitor.

Using ceramic capacitors, the impedance at the switching frequency is dominated by the capacitance. The output voltage ripple is mainly caused by the capacitance. For simplification, the output voltage ripple can be estimated by:

$$\Delta V_{OUT} = \frac{V_{OUT}}{8 \times f_s^2 \times L_1 \times C2} \times \left(1 - \frac{V_{OUT}}{V_{IN}} \right)$$

In the case of tantalum or electrolytic capacitors, the ESR dominates the impedance at the switching frequency. For simplification, the output ripple can be approximated to:

$$\Delta V_{OUT} = \frac{V_{OUT}}{f_s \times L_1} \times \left(1 - \frac{V_{OUT}}{V_{IN}} \right) \times R_{ESR}$$

The characteristics of the output capacitor also affect the stability of the regulation system.

PCB Layout

The high current paths (GND, VIN and SW) should be placed very close to the device with short, direct and wide traces. The input capacitor needs to be as close as possible to the VIN and GND pins. The external feedback resistors should be placed next to the FB pin. Keep the switching node SW short and away from the feedback network.

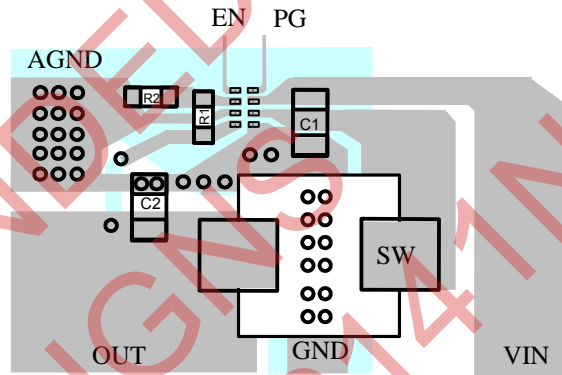

Design example

Below is a design example following the application guidelines for the following specifications:

Table 2: Design Example

V_{IN}	5V
V_{OUT}	1.2V
frequency	3.5MHz

The typical application circuit for $V_{OUT} = 1.2V$ on page 12 shows the detailed application schematic, and is the basis for the typical performance and circuit waveforms. For more detailed device applications, please refer to the related Evaluation Board Datasheets.

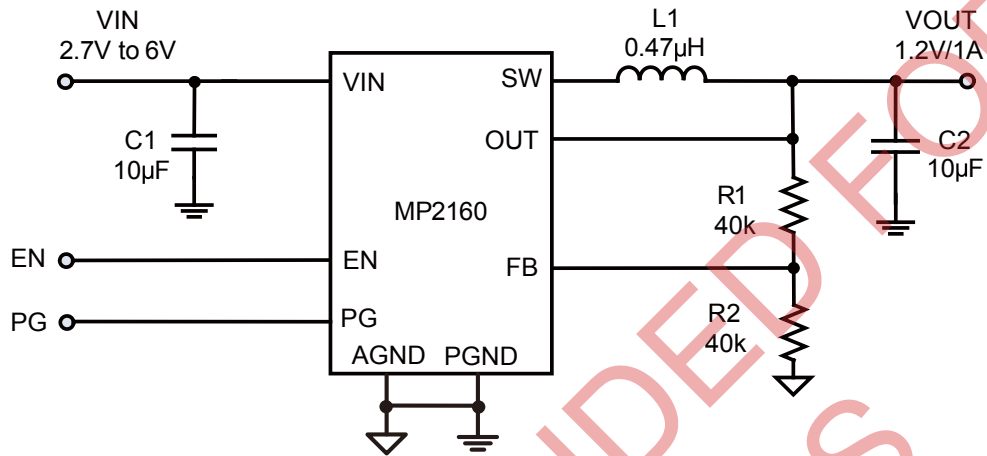
TYPICAL APPLICATION CIRCUITS

Figure 3: Typical Application Circuit

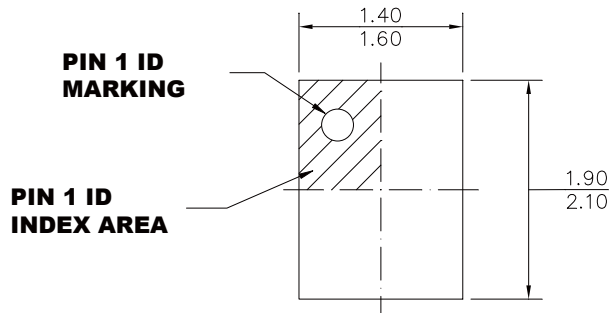
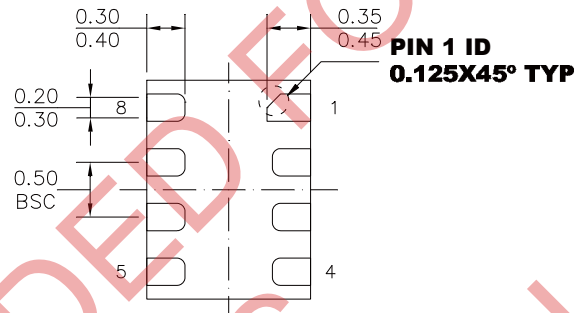
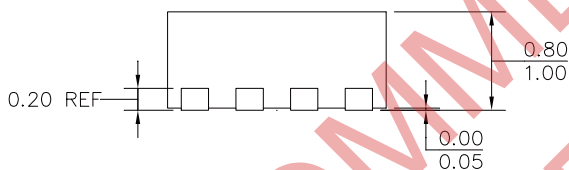
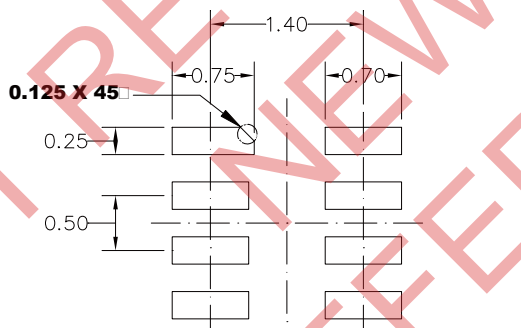
NOT RECOMMENDED FOR NEW DESIGNERS REFER TO MP2141N

PACKAGE INFORMATION
QFN8 (1.5X2.0mm)

TOP VIEW

BOTTOM VIEW

SIDE VIEW

RECOMMENDED LAND PATTERN
NOTE:

- 1) ALL DIMENSIONS ARE IN MILLIMETERS.
- 2) EXPOSED PADDLE SIZE DOES NOT INCLUDE MOLD FLASH.
- 3) LEAD COPLANARITY SHALL BE 0.10 MILLIMETERS MAX.
- 4) JEDEC REFERENCE IS MO-220.
- 5) DRAWING IS NOT TO SCALE.

NOTICE: The information in this document is subject to change without notice. Please contact MPS for current specifications. Users should warrant and guarantee that third party Intellectual Property rights are not infringed upon when integrating MPS products into any application. MPS will not assume any legal responsibility for any said applications.