

DESCRIPTION

The MCS1802 is a Hall effect-based linear current sensor IC for AC or DC current sensing. The Hall array is differential to cancel out any stray magnetic field.

A low resistance primary conductor allows current flow within close proximity of an integrated circuit containing high accuracy Hall sensors. This current generates a magnetic field which is sensed at two different points by the integrated Hall transducers. The magnetic field difference between these two points is then converted into a voltage proportional to the applied current. Spinning current technique is used for a low stable offset.

The galvanic isolation between the pins of the primary conductive path and the sensor leads allows the MCS1802 to replace opto-isolators or other expensive isolation devices.

The MCS1802 requires a minimum number of readily available, standard external components. It is available in a SOIC-8 package. The small footprint saves board area and is ideal for space-constrained applications.

FEATURES

- 3.3V single supply
- Immune to external magnetic fields by differential sensing
- 2.4 kV RMS minimum isolation voltage from pins 1-4 to pins 5-8
- Operating temperature -40°C to 125°C
- 0.9 mΩ internal conductor resistance
- 5 to 50 A range (see ordering information)
- Adjustable bandwidth, up to 100kHz
- 4 μs output rise time
- Ratiometric output from supply voltage
- Output proportional to AC or DC currents
- Factory-trimmed for accuracy
- No magnetic hysteresis
- Integrated shield suppressing capacitive coupling from current conductor to die (up to 10V/ns)
- SOIC-8 package

APPLICATIONS

- Motor control
- Automotive systems
- Load detection & management
- Switched-mode power supplies
- Over-current fault protection

All MPS parts are lead-free, halogen-free, and adhere to the RoHS directive. For MPS green status, please visit the MPS website under Quality Assurance. "MPS", the MPS logo, and "Simple, Easy Solutions" are trademarks of Monolithic Power Systems, Inc. or its subsidiaries.

TYPICAL APPLICATION

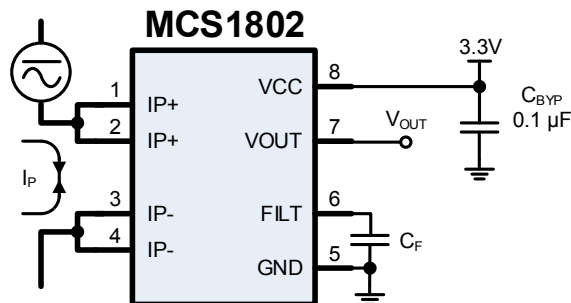

V_{OUT} is proportional to I_P within the range specified. The noise vs bandwidth tradeoff can be adjusted by C_F connected between FILT and GND.



ORDERING INFORMATION

Part Number*	Optimized Primary Current Range (A)	Typ. Sensitivity (Sens) (mV/A)	Top marking
MCS1802GS-05	±5	264	MC180205
MCS1802GS-10	±10	132	MC180210
MCS1802GS-20	±20	66	MC180220
MCS1802GS-30	±30	44	MC180230
MCS1802GS-40	±40	33	MC180240
MCS1802GS-50	±50	26.4	MC180250

* For Tape & Reel, add suffix -Z (e.g.: MCS1802GS-05-Z).

TOP MARKING (MCS1802GS-05)

MC180205
LLLLLLLL
MPSYWW

MC180205: Part number
LLLLLLLL: Lot number
MPS: MPS prefix
Y: Year code
WW: Week code

TOP MARKING (MCS1802GS-10)

MC180210
LLLLLLLL
MPSYWW

MC180210: Part number
LLLLLLLL: Lot number
MPS: MPS prefix
Y: Year code
WW: Week code



TOP MARKING (MCS1802GS-20)

MC180220

LLLLLLLL

MPSYWW

MC180220: Part number

LLLLLLLL: Lot number

MPS: MPS prefix

Y: Year code

WW: Week code

TOP MARKING (MCS1802GS-30)

MC180230

LLLLLLLL

MPSYWW

MC180230: Part number

LLLLLLLL: Lot number

MPS: MPS prefix

Y: Year code

WW: Week code

TOP MARKING (MCS1802GS-40)

MC180240

LLLLLLLL

MPSYWW

MC180240: Part number

LLLLLLLL: Lot number

MPS: MPS prefix

Y: Year code

WW: Week code

TOP MARKING (MCS1802GS-50)

MC180250

LLLLLLLL

MPSYWW

MC180250: Part number

LLLLLLLL: Lot number

MPS: MPS prefix

Y: Year code

WW: Week code

PACKAGE REFERENCE

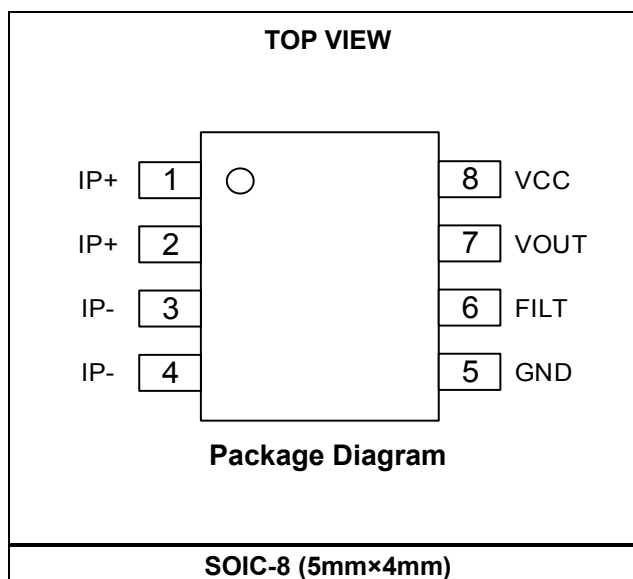

PIN FUNCTIONS

Package Pin #	Name	Description
1,2	IP+	Primary current + Terminals for current being sampled; fused internally.
3,4	IP-	Primary current - Terminals for current being sampled; fused internally.
5	GND	Ground. Signal ground terminal
6	FILT	Filter. Terminal for the external capacitor C_F setting the bandwidth. Can be unconnected.
7	VOUT	Analog output.
8	VCC	Voltage Supply.



ABSOLUTE MAXIMUM RATINGS ⁽¹⁾

Supply Voltage VCC	-0.1V to 6V
Output Voltage VOUT	-0.1V to 6V
V _{FILT}	-0.1V to 6V
Junction Temperature	165°C
Lead Temperature	260°C
Storage Temperature.....	-65°C to +165°C

ESD Rating

PIN 6,7,8	
Human-body model (HBM)	±2000V
PIN 5,6,7,8	
Charge device model (CDM)	±2000V

Recommended Operating Conditions ⁽²⁾

Supply voltage (V _{IN})	3.0V to 3.6V
Operating junction temp. (T _J)....	-40°C to +125°C

Notes:

- (1) Exceeding these ratings may damage the device.
- (2) The device is not guaranteed to function outside of its operating conditions.

**ISOLATION CHARACTERISTICS**

Parameters	Symbol	Condition	Rating	Units
Withstand Isolation Voltage	V_{ISO}	100% Production tested at $1.2 \times V_{ISO}$ for 1 second. Agency type-tested at V_{ISO} for 60 seconds in accordance with UL157.	2400	V_{RMS}
Maximum isolation working voltage	V_{IOWM}	Maximum approved working voltage for basic (single) isolation according UL60950-1 (edition 2).	420	VDC or V_{PK}
			300	V_{RMS}
External Clearance	CLR	Shortest distance through air from IP leads to signal leads	4.2	mm
External Creepage	CPG	Shortest distance along package body from IP leads to signal leads	4.2	mm

MCS1802 COMMON ELECTRICAL CHARACTERISTICS ⁽³⁾

 Typical values are VCC=3.3V, C_F=0nF, C_L=1nF, T_J=-40°C to +125°C, unless otherwise noted.

Parameters	Symbol	Condition	Min	Typ	Max	Units
Supply Voltage	VCC		3.0		3.6	V
VCC Under-voltage Lockout Threshold	VCC _{UVLO}	VCC falling	2	2.3	2.6	V
VCC Under-voltage Lockout Hysteresis	VCC _{UVLO} _{_HYS}			400	600	mV
Operating Supply Current	I _{CC}	VCC=3.3V		8.5	10.5	mA
Output Capacitance Load ⁽⁹⁾	C _L	From VOUT to GND			10	nF
Output Resistive Load ⁽⁹⁾	R _L	From VOUT to GND	4.7			kΩ
Primary Conductor Resistance	R _P	Effective		0.9		mΩ
Frequency Bandwidth ⁽⁹⁾	f _{BW}	FILT unconnected		100		kHz
Internal Filter Resistance ⁽⁹⁾	R _{Fi}			1.5		kΩ
Internal Filter Capacitance ⁽⁹⁾	C _{Fi}			1		nF
Power-On Time ⁽⁹⁾	t _{PO}	I _P =I _P MAX, FILT unconnected		90		μs
Rise Time ⁽⁹⁾	t _r	I _P =I _P MAX, FILT unconnected		4		μs
Propagation Delay ⁽⁹⁾	t _{pd}	I _P =I _P MAX, FILT unconnected		1.5		μs
Response Time ⁽⁹⁾	t _{RESPONSE}	I _P =I _P MAX, FILT unconnected		5		μs
Noise Density ⁽⁹⁾	I _{ND}	Input referenced noise density		200		μA(rms) /√Hz
Noise ⁽⁹⁾	I _N	Input referred, 1nF on FILT (60kHz Bandwidth)		50		mA(rms)
Nonlinearity ⁽⁹⁾	E _{LIN}	Over full range of I _P		0.5		%
Ratiometry	K _{sens}	VCC=3.0 to 3.6V	98	100	102	%
	K _{V0}	VCC=3.0 to 3.6V, I _P =0A	99	100	101	%
Zero Current Output Voltage	V _{OUT(Q)(I_P=0)}	I _P =0A		VCC/2		V
First Hall Magnetic Coupling Factor ⁽⁹⁾	P _{MCF1}		1.1	1.2	1.3	mT/A
Second Hall Magnetic Coupling Factor ⁽⁹⁾	P _{MCF2}		0.60	0.65	0.70	mT/A
Hall Plate Matching ⁽⁹⁾	M _H			±1		%
Saturation Voltage ⁽⁴⁾	V _{OUT(H)}	R _L =4.7kΩ, T _J =25°C	VCC - 0.3			V
	V _{OUT(L)}	R _L =4.7kΩ, T _J =25°C			0.3	V

MCS1802-05 PERFORMANCE CHARACTERISTICS ⁽³⁾
VCC=3.3V, C_F=0nF, C_L=1nF, T_J=-40°C to +125°C, unless otherwise noted.

Parameters	Symbol	Condition	Min	Typ ⁽¹⁰⁾	Max	Units
Optimized Accuracy Range ⁽⁵⁾	I _P		-5		5	A
Sensitivity	Sens	-5A ≤ I _P ≤ 5A, T _J =25°C		264		mV/A
Sensitivity Error	E _{Sens}	I _P =5A, T _J =25°C to 125°C	-2		2	%
		I _P =5A, T _J =-40°C to 25°C		±1.5		%
Offset Voltage ⁽⁶⁾	V _{OE}	I _P =0A, T _J =25°C to 125°C	-10		10	mV
		I _P =0A, T _J =-40°C to 25°C		±5		mV
Total Output Error ⁽⁷⁾	E _{TOT}	I _P =5A, T _J =25°C to 125°C	-2.5		2.5	%
		I _P =5A, T _J =-40°C to 25°C		±1.5		%
Sensitivity Error Lifetime Drift ⁽⁹⁾	E _{Sens(D)}			±1		%
Total Output Error Lifetime Drift ⁽⁹⁾	E _{TOT(D)}			±1		%

MCS1802-10 PERFORMANCE CHARACTERISTICS ⁽³⁾
VCC=3.3V, C_F=0nF, C_L=1nF, T_J=-40°C to +125°C, unless otherwise noted.

Parameters	Symbol	Condition	Min	Typ ⁽¹⁰⁾	Max	Units
Optimized Accuracy Range ⁽⁵⁾	I _P		-10		10	A
Sensitivity	Sens	-10A ≤ I _P ≤ 10A, T _J =25°C		132		mV/A
Sensitivity Error	E _{Sens}	I _P =10A, T _J =25°C to 125°C	-2		2	%
		I _P =10A, T _J =-40°C to 25°C		±1.5		%
Offset Voltage ⁽⁶⁾	V _{OE}	I _P =0A, T _J =25°C to 125°C	-10		10	mV
		I _P =0A, T _J =-40°C to 25°C		±5		mV
Total Output Error ⁽⁷⁾	E _{TOT}	I _P =10A, T _J =25°C to 125°C	-2.5		2.5	%
		I _P =10A, T _J =-40°C to 25°C		±1.5		%
Sensitivity Error Lifetime Drift ⁽⁹⁾	E _{Sens(D)}			±1		%
Total Output Error Lifetime Drift ⁽⁹⁾	E _{TOT(D)}			±1		%

MCS1802-20 PERFORMANCE CHARACTERISTICS ⁽³⁾
VCC=3.3V, C_F=0nF, C_L=1nF, T_J=-40°C to +125°C, unless otherwise noted.

Parameters	Symbol	Condition	Min	Typ ⁽¹⁰⁾	Max	Units
Optimized Accuracy Range ⁽⁵⁾	I _P		-20		20	A
Sensitivity	Sens	-20A ≤ I _P ≤ 20A, T _J =25°C		66		mV/A
Sensitivity Error	E _{Sens}	I _P =20A, T _J =25°C to 125°C	-2		2	%
		I _P =20A, T _J =-40°C to 25°C		±1.5		%
Offset Voltage ⁽⁶⁾	V _{OE}	I _P =0A, T _J =25°C to 125°C	-10		10	mV
		I _P =0A, T _J =-40°C to 25°C		±5		mV
Total Output Error ⁽⁷⁾	E _{TOT}	I _P =20A, T _J =25°C to 125°C	-2.5		2.5	%
		I _P =20A, T _J =-40°C to 25°C		±1.5		%
Sensitivity Error Lifetime Drift ⁽⁹⁾	E _{Sens(D)}			±1		%
Total Output Error Lifetime Drift ⁽⁹⁾	E _{TOT(D)}			±1		%

MCS1802-30 PERFORMANCE CHARACTERISTICS ⁽³⁾
VCC=3.3V, C_F=0nF, C_L=1nF, T_J=-40°C to +125°C, unless otherwise noted.

Parameters	Symbol	Condition	Min	Typ ⁽¹⁰⁾	Max	Units
Optimized Accuracy Range ⁽⁵⁾	I _P		-30		30	A
Sensitivity	Sens	-30A ≤ I _P ≤ 30A, T _J =25°C		44		mV/A
Sensitivity Error	E _{Sens}	I _P =30A, T _J =25°C to 125°C	-1.5		1.5	%
		I _P =30A, T _J =-40°C to 25°C		±1.5		%
Offset Voltage ⁽⁶⁾	V _{OE}	I _P =0A, T _J =25°C to 125°C	-10		10	mV
		I _P =0A, T _J =-40°C to 25°C		±5		mV
Total Output Error ⁽⁷⁾	E _{TOT}	I _P =30A, T _J =25°C to 125°C	-2.5		2.5	%
		I _P =30A, T _J =-40°C to 25°C		±1.5		%
Sensitivity Error Lifetime Drift ⁽⁹⁾	E _{Sens(D)}			±1		%
Total Output Error Lifetime Drift ⁽⁹⁾	E _{TOT(D)}			±1		%

MCS1802-40 PERFORMANCE CHARACTERISTICS ⁽³⁾
VCC=3.3V, C_F=0nF, C_L=1nF, T_J=-40°C to +125°C, unless otherwise noted.

Parameters	Symbol	Condition	Min	Typ ⁽¹⁰⁾	Max	Units
Optimized Accuracy Range ⁽⁵⁾	I _P		-40		40	A
Sensitivity	Sens	-40A ≤ I _P ≤ 40A, T _J =25°C		33		mV/A
Sensitivity Error	E _{Sens}	I _P =40A, T _J =25°C to 125°C	-2		2	%
		I _P =40A, T _J =-40°C to 25°C		±1.5		%
Offset Voltage ⁽⁶⁾	V _{OE}	I _P =0A, T _J =25°C to 125°C	-10		10	mV
		I _P =0A, T _J =-40°C to 25°C		±5		mV
Total Output Error ⁽⁷⁾	E _{TOT}	I _P =40A, T _J =25°C to 125°C	-2.5		2.5	%
		I _P =40A, T _J =-40°C to 25°C		±1.5		%
Sensitivity Error Lifetime Drift ⁽⁹⁾	E _{Sens(D)}			±1		%
Total Output Error Lifetime Drift ⁽⁹⁾	E _{TOT(D)}			±1		%

MCS1802-50 PERFORMANCE CHARACTERISTICS ⁽⁵⁾
VCC=3.3V, C_F=0nF, C_L=1nF, T_J=-40°C to +125°C, unless otherwise noted.

Parameters	Symbol	Condition	Min	Typ ⁽¹⁰⁾	Max	Units
Optimized Accuracy Range ⁽⁵⁾	I _P		-50		50	A
Sensitivity	Sens	-50A ≤ I _P ≤ 50A, T _J =25°C		26.4		mV/A
Sensitivity Error	E _{Sens}	I _P =50A, T _J =25°C to 125°C	-2		2	%
		I _P =50A, T _J =-40°C to 25°C		±1.5		%
Offset Voltage ⁽⁶⁾	V _{OE}	I _P =0A, T _J =25°C to 125°C	-10		10	mV
		I _P =0A, T _J =-40°C to 25°C		±5		mV
Total Output Error ⁽⁷⁾	E _{TOT}	I _P =50A, T _J =25°C to 125°C	-2.5		2.5	%
		I _P =50A, T _J =-40°C to 25°C		±1.5		%
Sensitivity Error Lifetime Drift ⁽⁹⁾	E _{Sens(D)}			±1		%
Total Output Error Lifetime Drift ⁽⁹⁾	E _{TOT(D)}			±1		%

Notes:

- (3) See below for the definitions of characteristics.
- (4) The IC continues to respond to current beyond the range of I_P until the high or low saturation voltage; however, the nonlinearity in the region I_P beyond is worse than through the rest of the measurement range.
- (5) Device may be operated at higher primary current levels I_P and ambient temperatures T_A, provided that the Maximum Junction Temperature T_J(MAX) is not exceeded.
- (6) Offset Voltage does not incorporate any error due to external magnetic fields.
- (7) Percentage of I_P, with I_P = I_{P,MAX}. Output filtered.
- (8) Guaranteed by design.
- (9) Guaranteed by characterization.
- (10) Typical values with "±" are ±3 sigma values.
- (11) The resistance is defined as the total resistance measured from a point of the lead just next to the solder joint (see figure below), and assuming that the two IP+ pins (and IP- pins) have the same potential. This definition corresponds to the effective resistance used to estimate the Joule heating with $R I_P^2$.

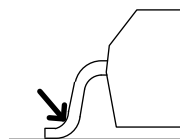

TYPICAL CHARACTERISTICS

MCS1802GS-50

Offset Voltage vs. Temperature

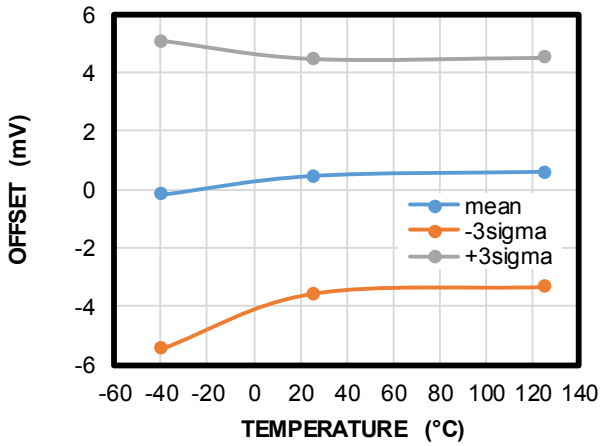

Sensitivity vs. Temperature

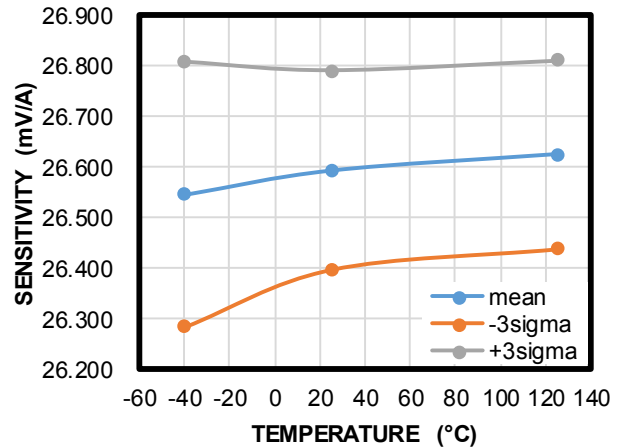

Sensitivity Error vs. Temperature

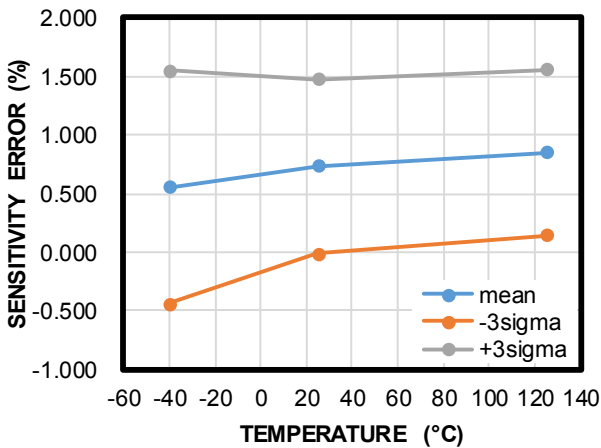

Total Error vs. Temperature

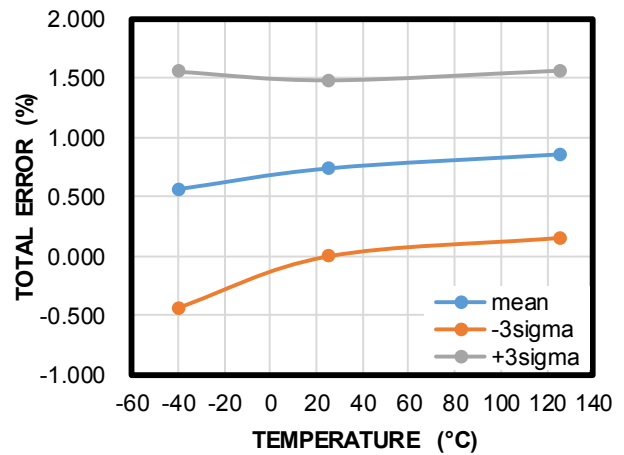

BLOCK DIAGRAM

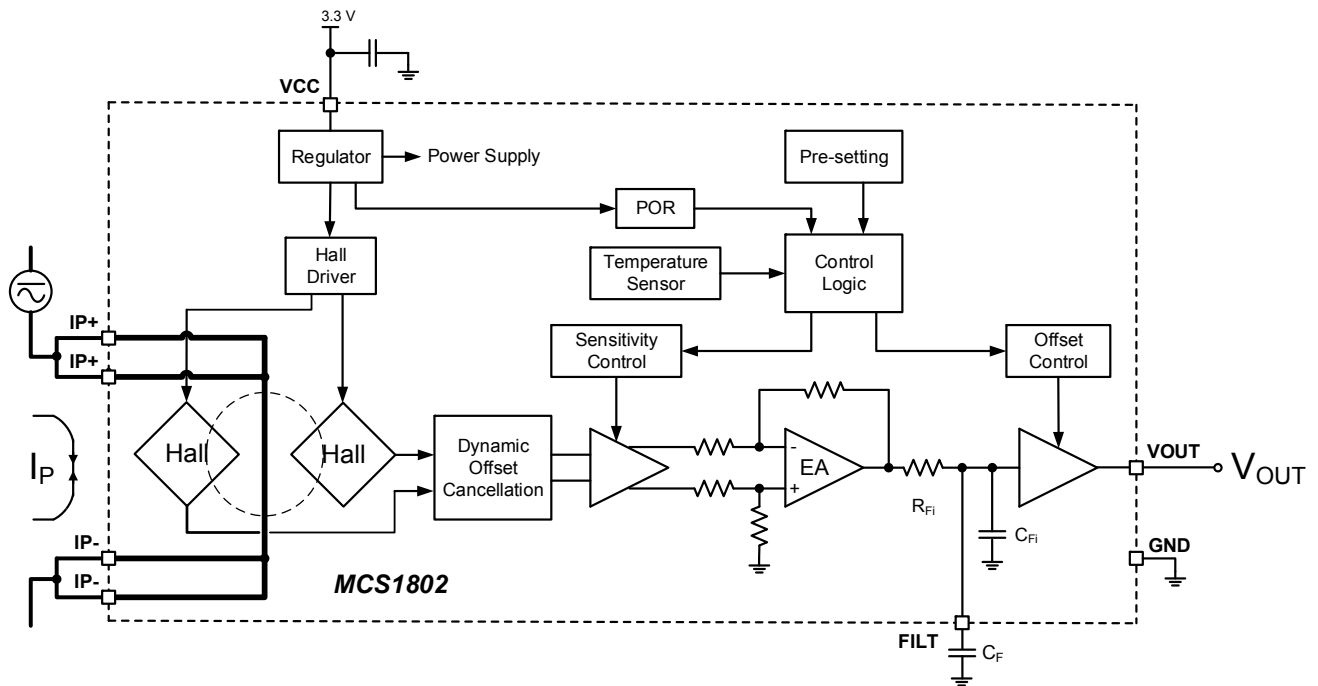

Figure 1: Functional Block Diagram

DEFINITIONS

Current rating

$I_{P_{MAX}}$ is the rated current. The sensor output is linear as a function of the primary current I_P and follows the specified performances when I_P is between $-I_{P_{MAX}}$ and $+I_{P_{MAX}}$.

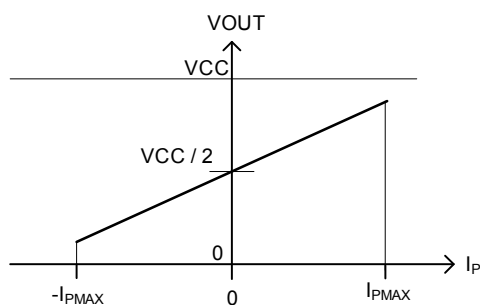

Figure 2 : sensor output function

Sensitivity (Sens)

The Sensitivity in mV/A indicates how much the output changes when the primary current changes. It is the product of the average between the 2 coupling constants P_{MCF1} and P_{MCF2} (in mT/A) and the transducer gain (in mV/mT). The gain is factory trimmed to the sensor target sensitivity.

Coupling constants (P_{MCF1} and P_{MCF2})

The first and second Hall magnetic coupling factor are defined as the amount of vertical magnetic field (see the arrows B_1 and B_2) produced at the sensing points 1 and 2, per unit of current injected in the primary conductor. Due to the non-symmetric shape of the primary conductor the magnetic field generated in the two sensing points are different.

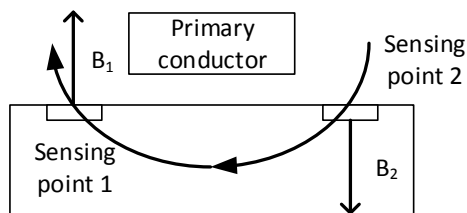

Figure 3: Schematic cross section of the sensor

Noise (V_{NOISE})

The noise is a random deviation and cannot be calibrated out. The input referred noise is the root mean square sensor output noise in mV, divided by the sensitivity in mV/A. It represents the smallest current that the device is able to

resolve, without any external signal treatment (it is generally accepted that the resolution is 3 times the rms noise).

Other deviations are systematic, meaning that they represent the average deviation over a large number of data points. They can be calibrated out.

Zero Current Output Voltage ($V_{OUT(Q)}$)

$V_{OUT(Q)}$ is the voltage output when the primary current is zero. The nominal value is $VCC/2$. Variation in $V_{OUT(Q)}$ from the nominal value is due to thermal drift and the resolution limits of voltage offset trimming in the factory.

Offset Voltage (V_{OE})

The difference between $VCC/2$ and the zero current output. To convert this voltage into amperes, divide by the sensitivity.

Nonlinearity (E_{LIN})

Ideally the primary current vs sensor output function is a straight line. The non-linearity is an indication of the worst deviation from this straight line.

The nonlinearity in % is defined by:

$$E_{LIN} = \frac{\max(V_{out}(I_P) - V_{lin}(I_P))}{V_{out}(I_{P_{MAX}}) - V_{out}(-I_{P_{MAX}})} \times 100$$

where $V_{lin}(I_P)$ is the approximate straight line calculated by the least square method. Note: depending on the curvature of $V_{out}(I_P)$, E_{LIN} can be negative or positive.

Total Output Error (E_{TOT})

E_{TOT} in % is the relative difference between the sensor output and the ideal output at a given primary current I_P :

$$E_{TOT}(I_P) = \frac{V_{out}(I_P) - V_{out\ ideal}(I_P)}{Sens \cdot I_P} \times 100$$

where,

$$V_{out\ ideal}(I_P) = \frac{VCC}{2} + Sens \cdot I_P$$

The Total Output Error incorporates all sources of error and is a function of I_P . At current close to $I_{P_{MAX}}$, the E_{TOT} error is affected mainly by

sensitivity error. At current close to zero, the E_{TOT} error is mostly due to the Offset Voltage (V_{OE}). Note that when $I_P = 0$, E_{TOT} diverges to infinity because of constant offset.

Ratiometry coefficients

Ideally the sensor output is ratiometric, it means that the sensitivity and the zero current output scales with VDD. The ratiometry coefficients measures how good is this proportionality.

$$K_{SENS} = \frac{Sens(VCC) / Sens(3.3V)}{VCC / 3.3V}$$

$$K_{VO} = \frac{V_{OUT}(I_P = 0, VCC) / V_{OUT}(I_P = 0, 3.3V)}{VCC / 3.3V}$$

Ideally both K_{SENS} and K_{VO} are 1.

Power-On Time (t_{PO})

This reflects the time interval after power is first applied to the device until the output can be considered to correctly indicate the applied primary current. The Power-On Time (t_{PO}) is defined as the time taken between the supply reaching the minimum operating voltage VCC_{MIN} (t_1), and the output voltage to settling to within $\pm 10\%$ of its steady state value under an applied primary current (t_2) (See Figure 4).

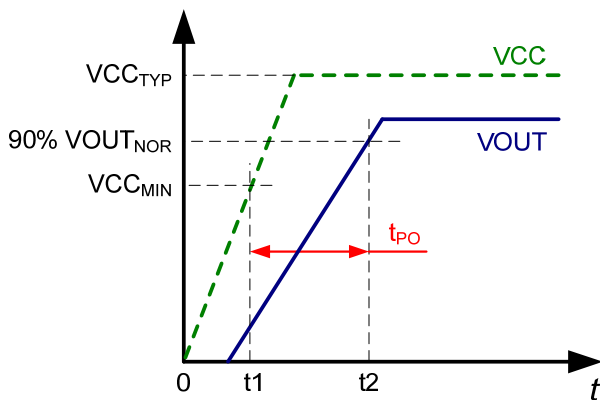

Figure 4: Power-On Time (t_{PO})

Propagation Delay (t_{pd})

The propagation delay represents the internal latency between an event to be measured and the sensor response. It is measured as a time interval between the primary current signal reaching 20% of I_{P_MAX} (t_1) and the time for the voltage to reach 20% of $VOUT_{MAX}$ (t_2). See Figure .

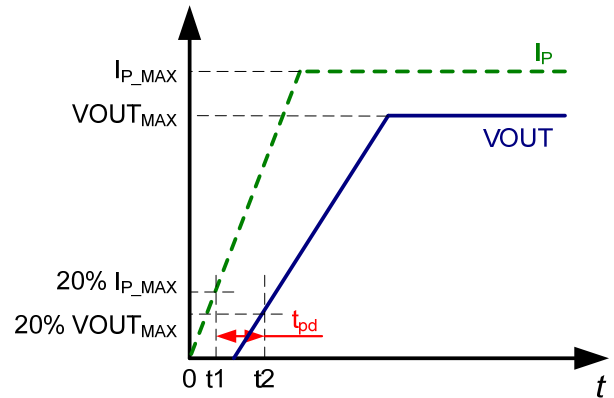

Figure 5: Propagation Delay (t_{pd})

Rise Time (t_r)

Rise Time is the time interval between the sensor VOUT reaching 10% of its full scale value (t_1), and it reaching 90% of its full scale value (t_2). See Figure 6. The sensor bandwidth, defined as the 3dB cutoff frequency, can be derived by the rise time of the response to an applied step by the relation:

$$f_{BW} = 0.35 / t_r$$

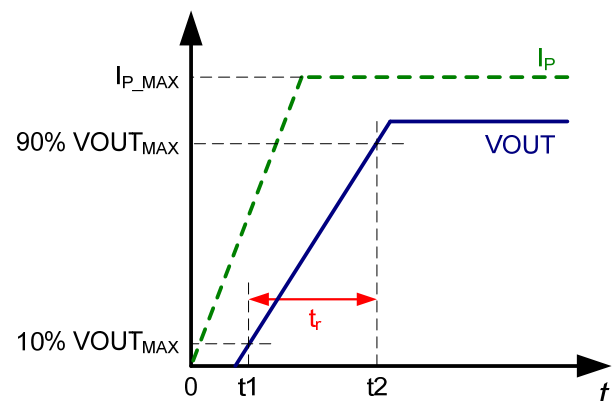

Figure 6: Rise Time (t_r)

Response Time ($t_{RESPONSE}$)

$t_{RESPONSE}$ is a combination of the previously defined times: it is the time interval between the primary current signal reaching 90% of its final value (t_1), and the device VOUT reaching 90% of its output corresponding to the applied primary current (t_2). (See Figure 7)

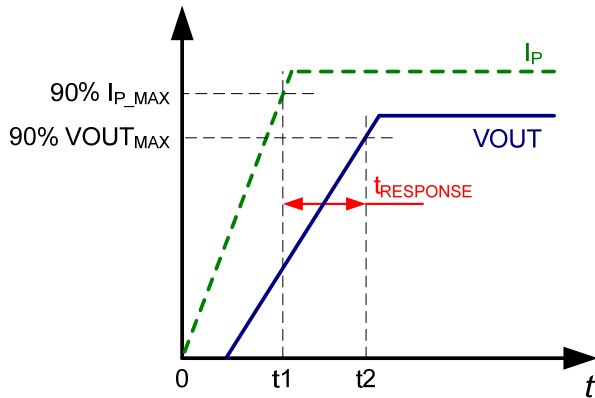

Figure 7: Response Time ($t_{RESPONSE}$)

Cut way ground/power planes under the IC to reduce the effect of eddy currents on t_r and $t_{RESPONSE}$.

Adjustable Bandwidth

The sensor dynamic can be adjusted by connecting the external capacitor C_F . The bandwidth can then be calculated with:

$$f_{BW} = \frac{1}{2\pi R_{Fi}} \frac{1}{(C_{Fi} + C_F)}$$

The typical bandwidth curve is shown as Figure 8.

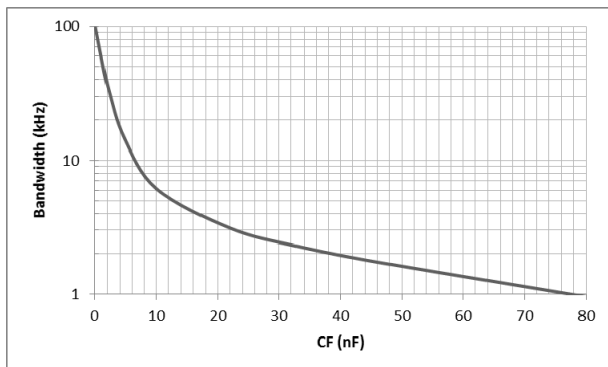

Figure 8: Bandwidth vs. C_F

APPLICATION INFORMATION

Self-heating Performance

Current flowing through the primary conductor can raise the conductor and the sensor IC temperature. Therefore self-heating should be carefully verified to ensure the IC junction does not exceed the maximum (see the absolute maximum rating table).

The thermal behavior strongly depends on thermal environment of the MCS components and its cooling capacity, in particular the PCB copper area and thickness. The thermal response also depends on the profile of the current waveform which means on the amplitude and frequency for an AC current, and on the peaks and duty cycle for a pulsed DC current.

The plot in Figure 9 shows the self-heating performance with DC current input. The data is collected with the part mounted on the MCS180X demo board at 25°C T_A after 10 minutes of continuous current.

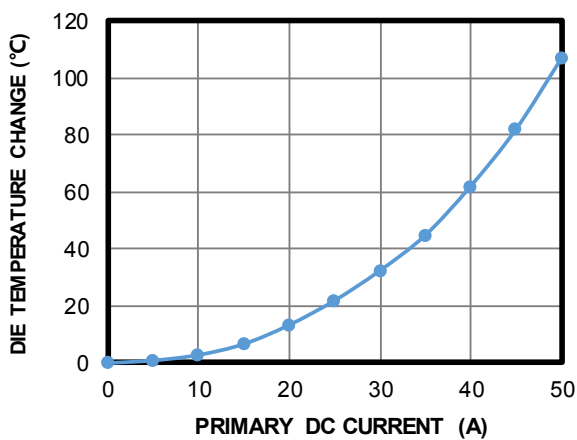

Figure 9: Self-heating Performance with DC Current Input

Figure 10 shows the top and bottom layers of the MCS180X demo board, the board includes in total 2200 mm², 4 oz (139 μm) copper connected to the primary conductor by the IP+ and IP- pins. The copper covers both the top and bottom side with thermal vias connecting the two layers.

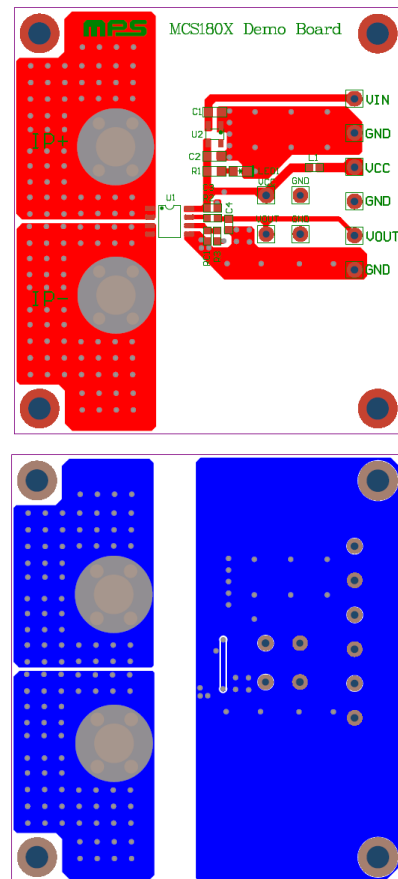

Figure 10: Top and Bottom Layers of MCS180X Demo Board

TYPICAL APPLICATION CIRCUITS

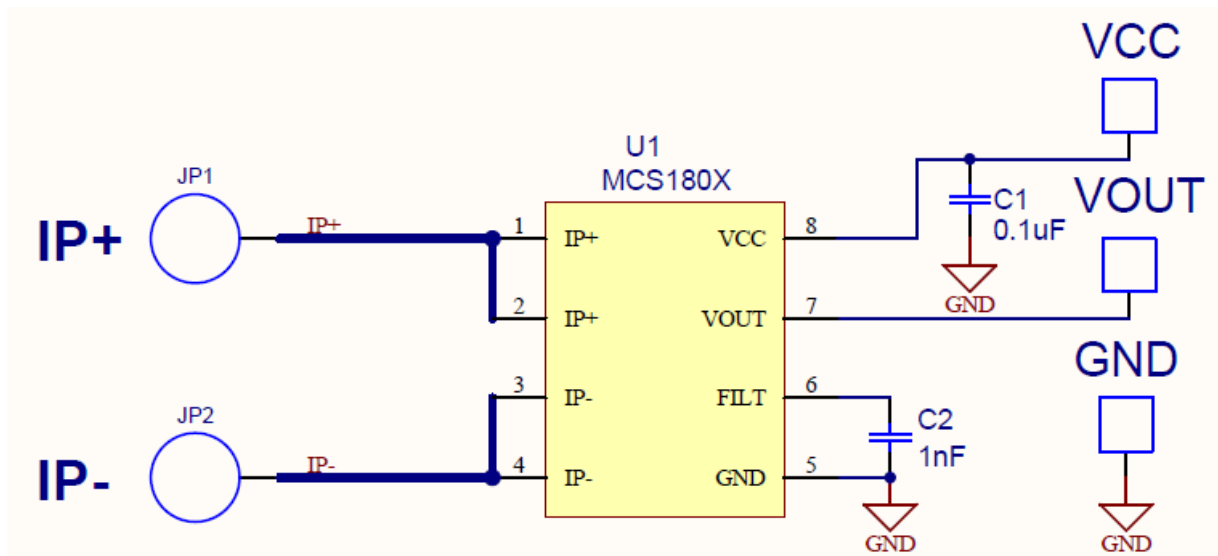
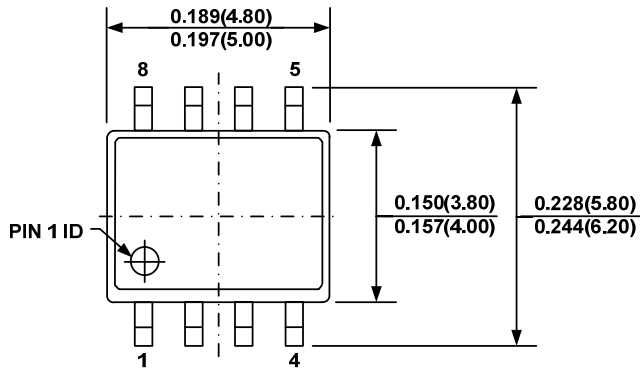

Figure 11: Application Circuit

PACKAGE INFORMATION

SOIC-8



TOP VIEW

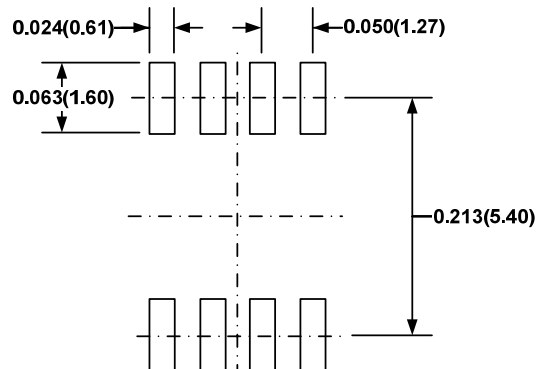

RECOMMENDED LAND PATTERN

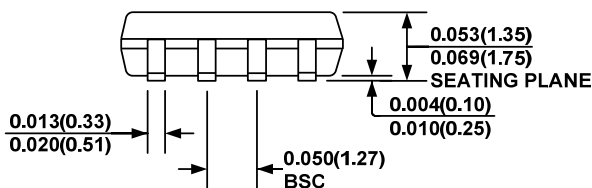

FRONT VIEW

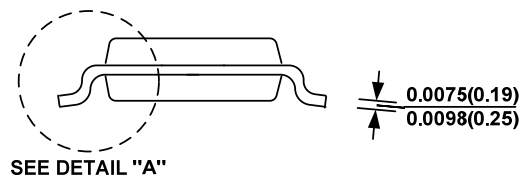

SEE DETAIL "A"

SIDE VIEW

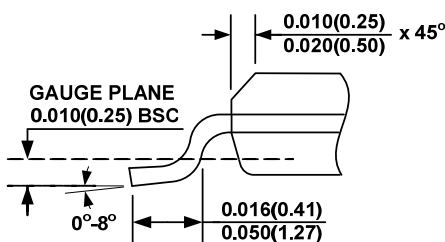

DETAIL "A"

NOTE:

- CONTROL DIMENSION IS IN INCHES. DIMENSION IN BRACKET IS IN MILLIMETERS.
- PACKAGE LENGTH DOES NOT INCLUDE MOLD FLASH, PROTRUSIONS OR GATE BURRS.
- PACKAGE WIDTH DOES NOT INCLUDE INTERLEAD FLASH OR PROTRUSIONS.
- LEAD COPLANARITY (BOTTOM OF LEADS AFTER FORMING) SHALL BE 0.004" INCHES MAX.
- DRAWING CONFORMS TO JEDEC MS-012, VARIATION AA.
- DRAWING IS NOT TO SCALE.

NOTICE: The information in this document is subject to change without notice. Please contact MPS for current specifications. Users should warrant and guarantee that third party Intellectual Property rights are not infringed upon when integrating MPS products into any application. MPS will not assume any legal responsibility for any said applications.