

## DESCRIPTION

The EVQ4488-U-00B Evaluation Board is designed to demonstrate the capabilities of MPS' MPQ4488. The MPQ4488 integrates a monolithic step-down switch-mode converter with two USB current-limit switches and charging port identification circuitry for each port. It achieves 6A output current over a wide input-supply range with excellent load and line regulation.

The output of the USB switch is current limited. Both USB ports support DCP schemes for Battery Charging specification (BC1.2), the Divider Mode, 1.2V/1.2V Mode and USB TYPE-C 5V@3A DFP Mode eliminating outside user interaction.

## ELECTRICAL SPECIFICATION

Parameter	Symbol	Value	Units
Operating Input Voltage	$V_{IN}$	12	V
Switching Frequency	$F_s$	450	kHz
Output Voltage	$V_{USB1}/V_{USB2}$	5.17	V
Output Current	USB1_ $I_{OUT}$	3	A
	USB2_ $I_{OUT}$	3	A

## FEATURES

- Wide 6V to 36V Operating Input-Voltage Range
- Selectable Output Voltage: 5.1V, 5.17V and 5.3V
- 90mV Line Drop Compensation
- Accurate USB1/USB2 Output-Current Limit
- 18mΩ/15mΩ Low  $R_{DS(ON)}$  Internal Buck Power MOSFETs
- 18mΩ/18mΩ Low  $R_{DS(ON)}$  Internal USB1/USB2 Power MOSFETs
- Load Shedding versus Temperature
- Hiccup Current Limit for both Buck and USB
- Supports DCP schemes for BC1.2, Divider Mode, and 1.2V/1.2V Mode
- Supports USB TYPE-C 5V@3A Mode

## APPLICATIONS

- USB Dedicated Charging Ports (DCP)
- USB Type-C Charging Port

All MPS parts are lead-free, halogen free, and adhere to the RoHS directive. For MPS green status, please visit MPS website under Quality Assurance.

"MPS" and "The Future of Analog IC Technology" are Registered Trademarks of Monolithic Power Systems, Inc.

## EVQ4488-U-00B EVALUATION BOARD

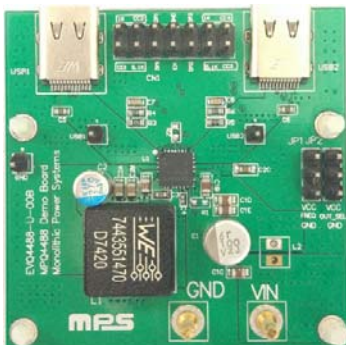

(L x W x H) 5cm x 5cm x 1.7cm  
(Four Layer PCB/2oz per layer)

Board Number	MPS IC Number
EVQ4488-U-00B	MPQ4488

## Efficiency vs. Load Current

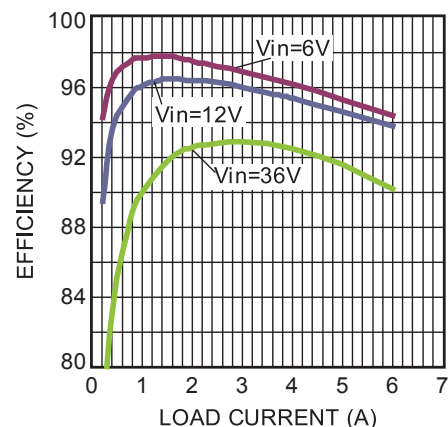

## EVALUATION BOARD SCHEMATIC

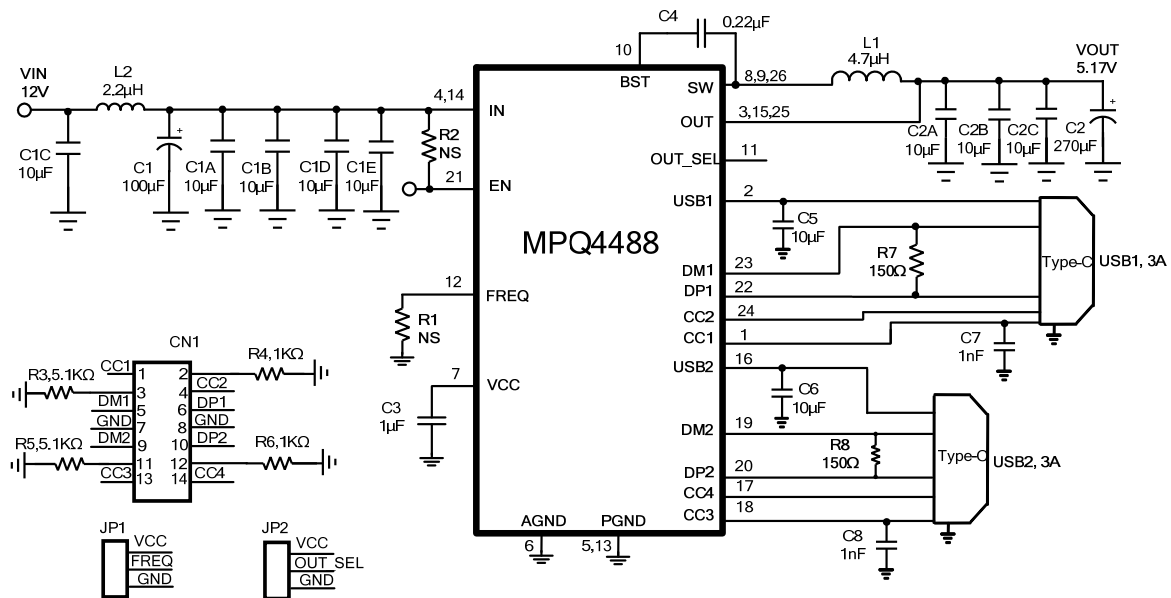

Note: R7 and R8 are on the bottom side of EVB board.

**EVQ4488-U-00B BILL OF MATERIALS**

Qty	Ref	Value	Description	Package	Manufacturer	Part Number
5	C1A, C1B, C1C, C1D, C1E	10 $\mu$ F	Ceramic Capacitor, 35V, X6S	0805	Murata	GRM21BC8YA106KE11
1	C1	100 $\mu$ F	Aluminum Electrolytic Capacitor, 35V, 160m $\Omega$ ESR	SMT	Chemi-Con	EMZJ35ADA101MF80G
1	C2	270 $\mu$ F	Polymer Capacitor, 6.3V	DIP	Chemi-Con	APSK6R3ELL271ME08S
2	C2A, C2B	10 $\mu$ F	Ceramic Capacitor, 10V, X7R	0805	Murata	GRM21BR71A106KE51L
1	C2C	10 $\mu$ F	Ceramic Capacitor, 6.3V, X7R	0603	Murata	GRM219R60J106KE19D
1	C3	1 $\mu$ F	Ceramic Capacitor, 16V, X7R	0603	Murata	GRM188R71C105KA12D
1	C4	0.22 $\mu$ F	Ceramic Capacitor, 10V, X5R	0402	Murata	GRM155R61A224KE19
2	C5, C6	10 $\mu$ F	Ceramic Capacitor, 6.3V, X7R	0603	Murata	GRM219R60J106KE19D
2	C7, C8	1nF	Ceramic Capacitor, 25V, X7R	0603	Murata	GRM188R71E102KA01D
0	R1, R2	NS				
2	R3, R5	5.1K $\Omega$	Film Resistor, 1%	0603	Royal	RL0603FR-075K1L
2	R4, R6	1K $\Omega$	Film Resistor, 1%	0603	Royal	RL0603FR-071KL
2	R7, R8	150 $\Omega$	Film Resistor, 1%	0603	Royal	RL0603FR-07150RL
1	L1	4.7 $\mu$ H	Inductor, DCR 7m $\Omega$	SMT	Würth	7443551470
1	L2	2.2 $\mu$ H	Inductor, DCR 29m $\Omega$	SMT	Würth	74438356022
2	USB1, USB2	USB	TYPE-C USB Port	DIP	Würth	632723300011
1	U1	MPQ4488	Step Down Converter with Dual USB Charging Port	QFN26 (5mmx5mm)	MPS	MPQ4488GU
1	CN1	Header	2.54mm, 14pin, Dual pin header, default all pins open	DIP	Würth	61301421121
2	JP1, JP2	Header	2.54mm, 3pin header, default all pins open	DIP	Würth	61300311121

## TYPICAL PERFORMANCE CHARACTERISTICS

$V_{IN} = 12V$ ,  $V_{OUT} = 5.17V$ ,  $L = 4.7\mu H$ ,  $T_A = 25^\circ C$ , unless otherwise noted.

### Output Ripple

$V_{IN}=12V$ ,  $V_{OUT}=5.17V$ ,  
 $USB1\_I_{OUT}=USB2\_I_{OUT}=0A$

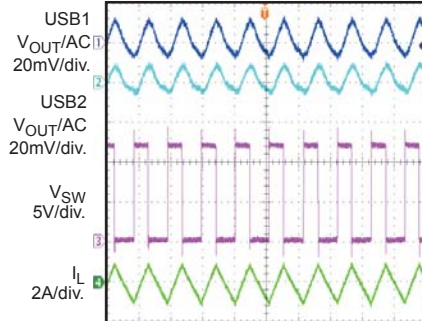

2 $\mu$ s/div.

### Output Ripple

$V_{IN}=12V$ ,  $V_{OUT}=5.17V$ ,  
 $USB1\_I_{OUT}=USB2\_I_{OUT}=3A$

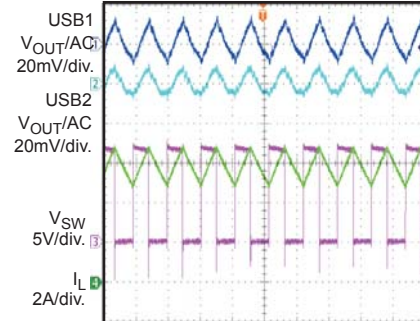

2 $\mu$ s/div.

### Power Start-up

$V_{IN}=12V$ ,  $V_{OUT}=5.17V$ ,  
 $USB1\_I_{OUT}=USB2\_I_{OUT}=0A$

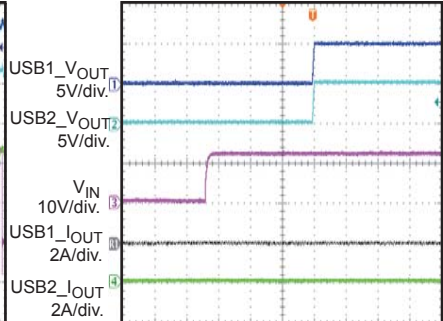

40ms/div.

### Power Start-up

$V_{IN}=12V$ ,  $V_{OUT}=5.17V$ ,  
 $USB1\_I_{OUT}=USB2\_I_{OUT}=3A$

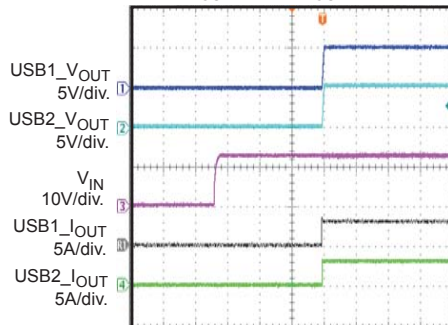

40ms/div

### Power Shutdown

$V_{IN}=12V$ ,  $V_{OUT}=5.17V$ ,  
 $USB1\_I_{OUT}=USB2\_I_{OUT}=0A$

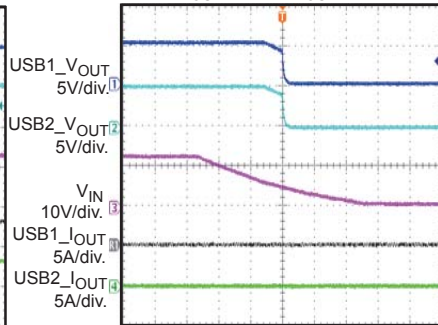

20ms/div

### Power Shutdown

$V_{IN}=12V$ ,  $V_{OUT}=5.17V$ ,  
 $USB1\_I_{OUT}=USB2\_I_{OUT}=3A$

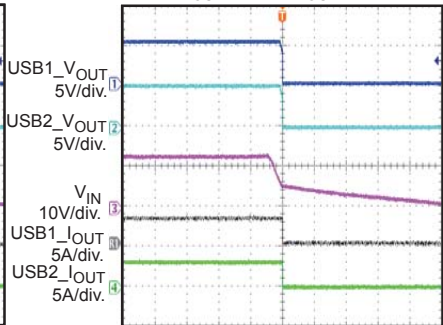

10ms/div

### USB Over-Current Protection

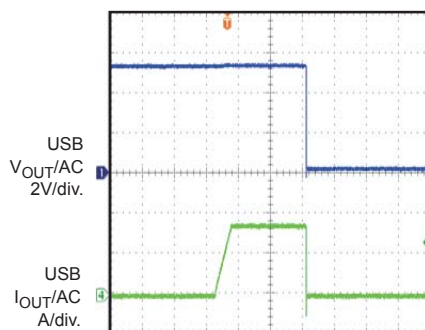

2ms/div

### Load Shedding Entry

$V_{IN}=12V$ ,  $V_{OUT}=5.17V$

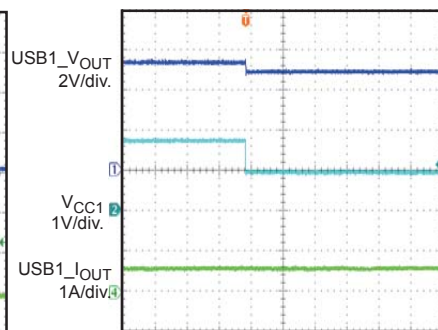

10ms/div

### Load Shedding Recovery

$V_{IN}=12V$ ,  $V_{OUT}=5.17V$

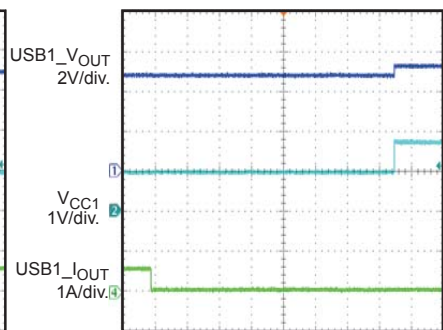

2s/div

**TYPICAL PERFORMANCE CHARACTERISTICS (continued)**

$V_{IN} = 12V$ ,  $V_{OUT} = 5.17V$ ,  $L = 4.7\mu H$ ,  $T_A = 25^{\circ}C$ , unless otherwise noted.

**Efficiency vs. Load Current**

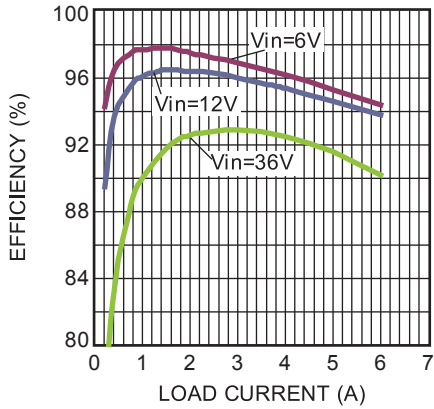

**Line Drop Compensation vs. Load Current**

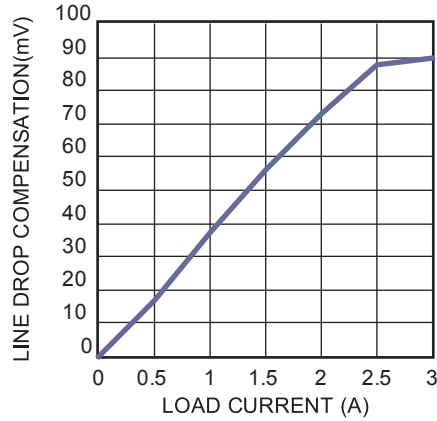

**Thermal Image**

$V_{IN}=12V$ ,  
 $USB1_{I_{OUT}}=USB2_{I_{OUT}}=2.4A$   
 4 layer PCB, 50mm x 50mm

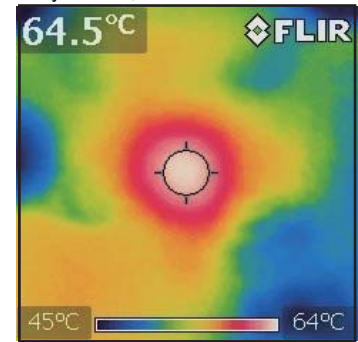

**Thermal Image**

$V_{in}=12V$ ,  
 $USB1_{I_{OUT}}=2.4A$ ,  $USB2_{I_{OUT}}=3A$   
 4 layer PCB, 50mmx50mm

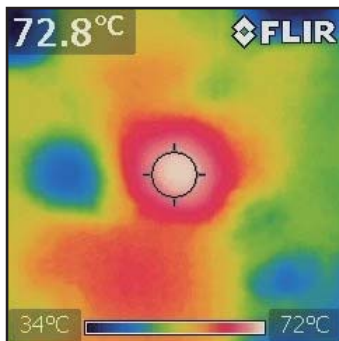

**Thermal Image**

$V_{IN}=12V$ ,  
 $USB1_{I_{OUT}}=3A$ ,  $USB2_{I_{OUT}}=3A$   
 4 layer PCB, 50mm x 50mm

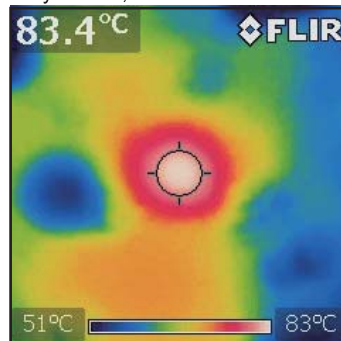

## PRINTED CIRCUIT BOARD LAYOUT

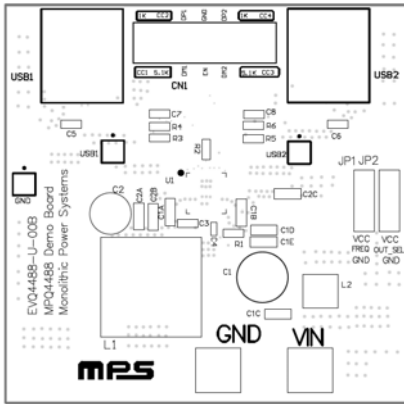

Figure 1—Top Silk Layer

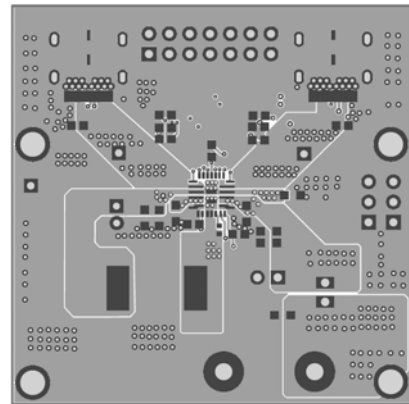

Figure 2—Top Layer

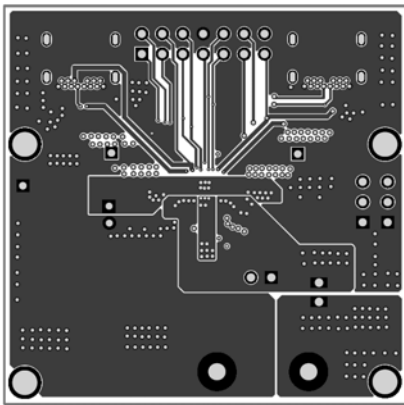

Figure 3—Middle1 Layer

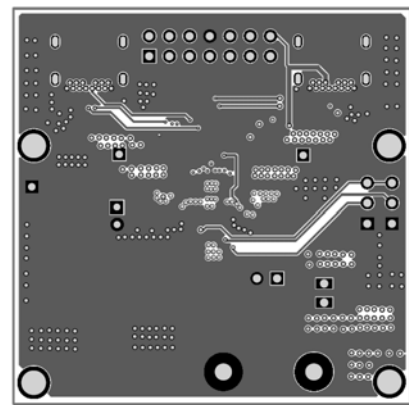

Figure 4—Middle2 Layer

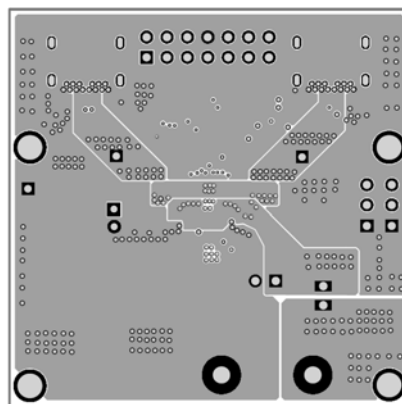

Figure 5—Bottom Layer



## QUICK START GUIDE

1. Connect the positive and negative terminals of the load to the USB1, USB2 and GND pins, respectively.
2. Preset the power supply output between 6V and 36V, and then turn off the power supply.
3. Connect the positive and negative terminals of the power supply output to the VIN and GND pins, respectively.
4. Turn the power supply on, the board will automatically start up. But if no type-C device is attached, there is no Vbus output.
5. For USB Type-C 5V/3A DFP mode, if no type-C device is attached, short pin1 and pin 3 of CN1 with a jumper to enable USB1 output, short pin 11 and pin 13 of CN1 with a jumper to enable USB2 output; short pin 2 and pin 4 of CN1 with a jumper to enable VCONN1 output, short pin 12 and pin 14 of CN1 with a jumper to enable VCONN2 output.

If type-C device is attached, all CN1 pins should be float.

6. For USB Type-A 5V/2.4A mode, change R3 =80.6k $\Omega$  and connect pin1 and pin 3 of CN1 with a jumper to enable USB1 output, change R5 =80.6k $\Omega$  and connect pin 11 and pin 13 of CN1 with a jumper to enable USB2 output. Keep R4, R6 float. Remove C7 and C8.

**NOTICE:** The information in this document is subject to change without notice. Please contact MPS for current specifications. Users should warrant and guarantee that third party Intellectual Property rights are not infringed upon when integrating MPS products into any application. MPS will not assume any legal responsibility for any said applications.