



The Future of Analog IC Technology®

# EVQ1530-Q-00A

Triple Output  
TFT Bias Converter EV Board  
AEC-Q100 Qualified

## DESCRIPTION

The EVQ1530-Q-00A evaluation board is designed to demonstrate the capabilities of MPS' MPQ1530 triple output step-up converter which is capable of powering a TFT panel from a regulated 3.3V or 5V.

The MPQ1530 includes a 1.4MHz fixed-frequency step-up converter and a positive and negative linear regulator. The linear regulators are powered from a charge-pump driven by the step-up converter switch node (SW).

A single on/off control enables all 3 outputs. The outputs are internally sequenced at power on and power off for ease of use. An internal soft-start prevents overloading the input source at startup. Cycle-by-cycle over current protection limits component overstress.

## ELECTRICAL SPECIFICATIONS

Parameter	Symbol	Value	Units
Input Voltage	$V_{IN}$	2.7 – 5.5	V
Output Voltage 1	$V_{MAIN}$	+13	V
Output Current 1	$I_{MAIN}$	350	mA
Output Voltage 2	$V_{GH}$	+27	V
Output Current 2	$I_{GH}$	20	mA
Output Voltage 3	$V_{GL}$	-8.5	V
Output Current 3	$I_{GL}$	20	mA

## FEATURES

- 2.7 to 5.5V Operating Input Range
- 2.8A Switch Current Limit
- 3 Outputs In Single Package
  - Step-Up Converter up to 22V
  - Positive 20mA Linear Regulator
  - Negative 20mA Linear Regulator
- 250mΩ Internal Power MOSFET Switch
- Up to 95% Efficiency
- 1μA Shutdown Mode
- Fixed 1.4MHz Frequency
- Positive Regulator up to 38V
- Negative Regulator down to -20V
- Internal Power-On Sequencing
- Adjustable Soft-Start/Fault Timer
- Thermal Shutdown
- Cycle-by-Cycle Over Current Protection
- Under Voltage Lockout
- Ready Flag

## APPLICATIONS

- TFT LCD Displays
- Portable DVD Players
- Tablet PCs
- Car Navigation Displays

All MPS parts are lead-free and adhere to the RoHS directive. For MPS green status, please visit MPS website under Products, Quality Assurance page. "MPS" and "The Future of Analog IC Technology" are registered trademarks of Monolithic Power Systems, Inc.

## EVQ1530-Q-00A EVALUATION BOARD

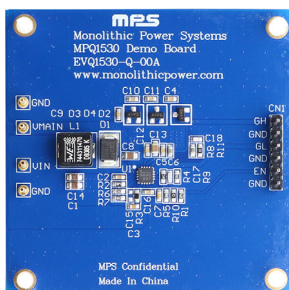

Dimensions (2.4"X x 2.2"Y x 0.5"Z)

Board Number	MPS IC Number
EVQ1530-Q-00A	MPQ1530

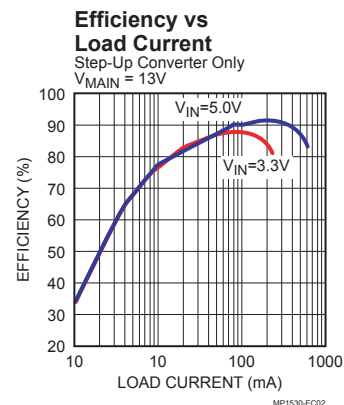

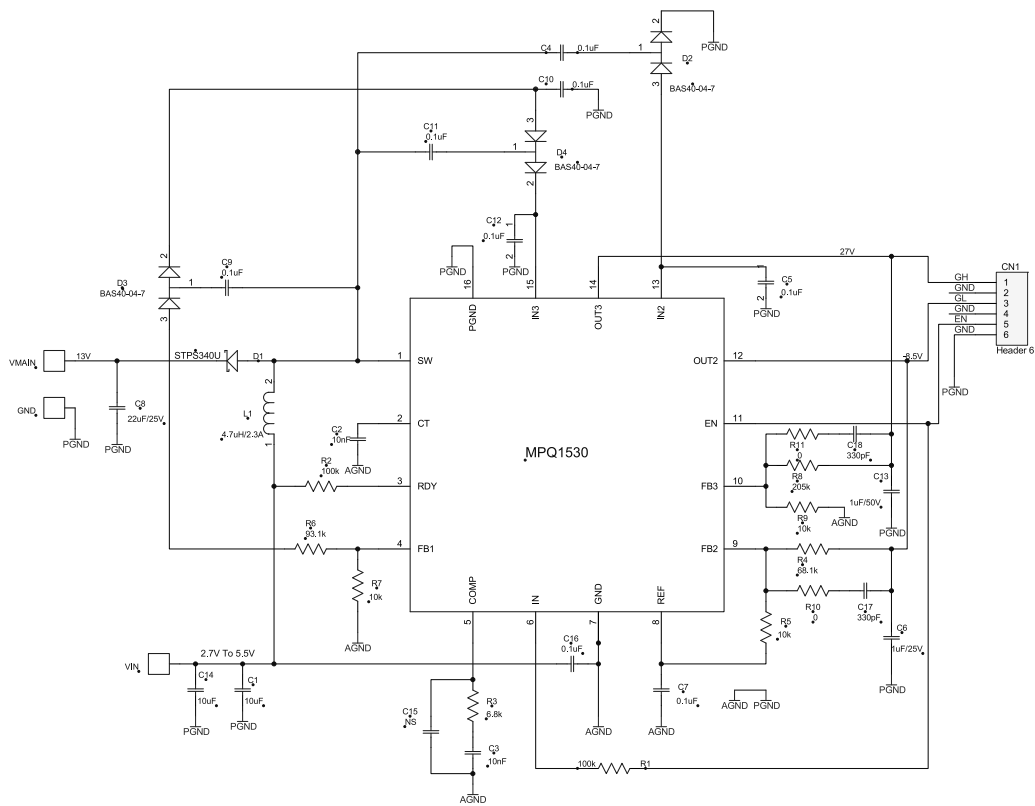
**EVALUATION BOARD SCHEMATIC**

**EVQ1530-Q-00A BILL OF MATERIALS**

Qty	Ref	Value	Description	Package	Manufacturer	Manufacturer P/N
2	C1, C14	10µF	Ceramic Cap., 16V, X5R	0805	MuRata	GRM21BR61C106KE15L
2	C3, C2	10nF	Ceramic Cap. 50V, X7R	0603	MuRata	GRM188R71H103KA01D
8	C4, C5, C7, C9, C10, C11, C12, C16	0.1µF	Ceramic Cap., 25V, X7R	0603	MuRata	GRM188R71H104KA93D
1	C6	1µF	Ceramic Cap., 25V, X7R	0603	MuRata	GCM188R71E105KA64D
1	C8	22µF	Ceramic Cap., 25V, X5R	0805	MuRata	GRM21BR61E226ME44L
1	C13	1µF	Ceramic Cap. 50V, X7R	0805	MuRata	GRT188R61H105KE13D
1	C15	NS	Ceramic Cap., 25V, X7R	0603		
2	C17, C18	330pF	0603	0603	MuRata	GRM188R71H331MA01D
1	D1	3A	Schottky Diode, 40V, 3A	SMB	ST Microelec	STPS340U
3	D2, D3, D4		Schottky Diode, 40V, 200mA	SOT23	Diodes Inc	BAS40-04DICT-ND
1	L1	4.7µH	SMD, Inductor 20mΩ	7x7x4mm	Würth	744311470
2	R1, R2	100kΩ	Film Resistor, 5%	0603	Yageo	RC0603JR-07100KL
1	R3	6.8kΩ	Film Res., 5%	0603	Yageo	RC0603JR-076K8L
1	R4	68.1kΩ	Film Res., 1%	0603	Yageo	RC0603FR-0768K1L

**EVQ1530-Q-00A BILL OF MATERIALS (continued)**

Qty	Ref	Value	Description	Package	Manufacturer P/N	Distributor P/N
3	R5, R7, R9	10k $\Omega$	Film Res., 5%	0603	Yageo	RC0603JR-0710KL
1	R6	93.1k $\Omega$	Film Res., 1%	0603	Yageo	RC0603FR-0793K1L
1	R8	205k $\Omega$	Film Res., 1%	0603	Yageo	RC0603FR-07205KL
2	R10, R11	0 $\Omega$	Film Res., 1%	0603	Yageo	RC0603JR-070RL
1	CN1	Header	6pins		Any	
4	V <sub>MAIN</sub> , GND, V <sub>IN</sub> , GND	TP	Test Point		Any	
1	U1	MPQ1530DQ	MPS	QFN16	MPS	MPQ1530DQ

## EVB TEST RESULTS

Performance waveforms are tested on the evaluation board.

$V_{IN} = 5V$ ,  $V_{MAIN} = 13V$ ,  $I_{MAIN} = 200mA$ ,  $V_{GL} = -8.5V$ ,  $I_{GL} = 10mA$ ,  $V_{GH} = 27V$ ,  $I_{GH} = 10mA$ ,  $T_A = +25^\circ C$ , unless otherwise noted.

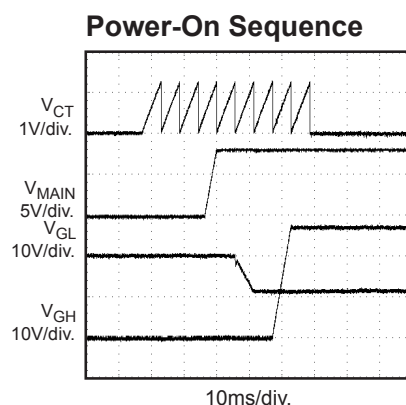
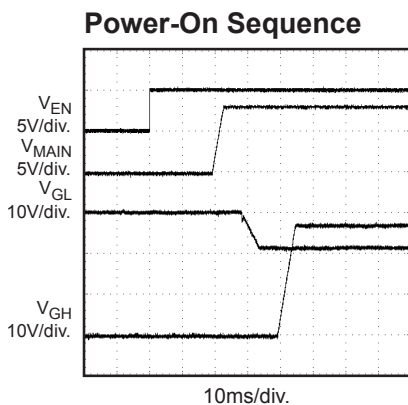
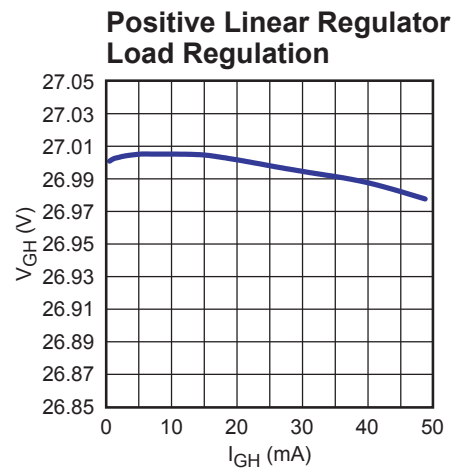
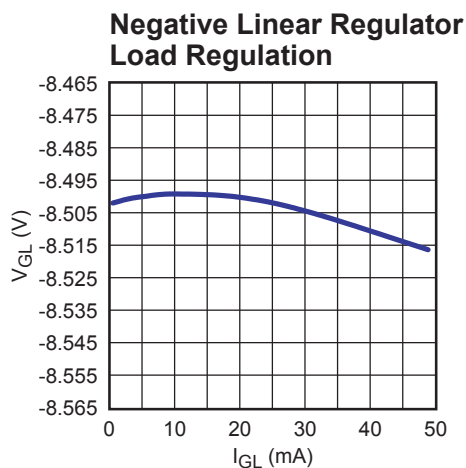
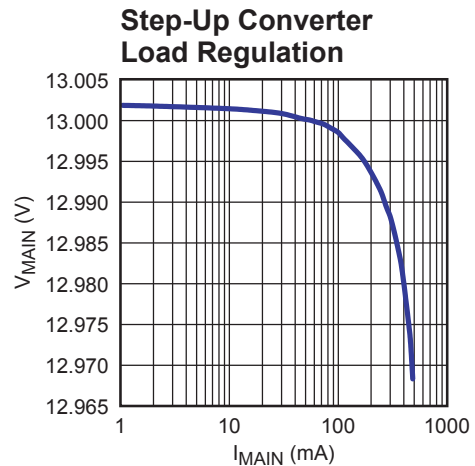
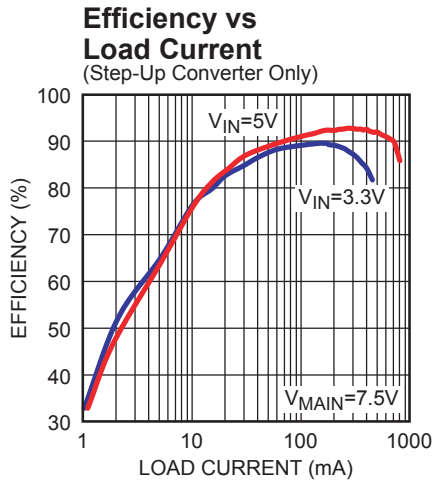

**EVB TEST RESULTS (continued)**

Performance waveforms are tested on the evaluation board.

 $V_{IN} = 5V$ ,  $V_{MAIN} = 13V$ ,  $I_{MAIN} = 200mA$ ,  $V_{GL} = -8.5V$ ,  $I_{GL} = 10mA$ ,  $V_{GH} = 27V$ ,  $I_{GH} = 10mA$ ,  $T_A = +25^{\circ}C$ , unless otherwise noted.

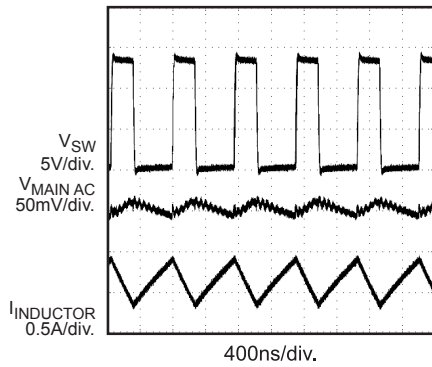
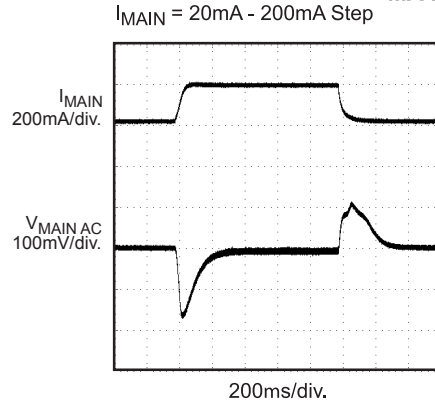
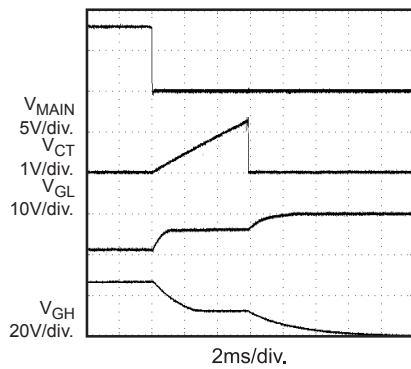
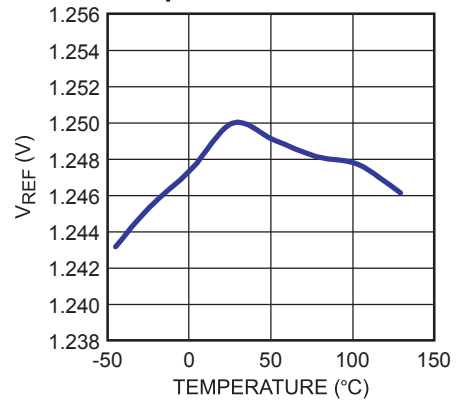
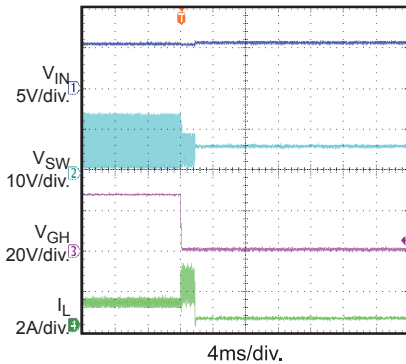
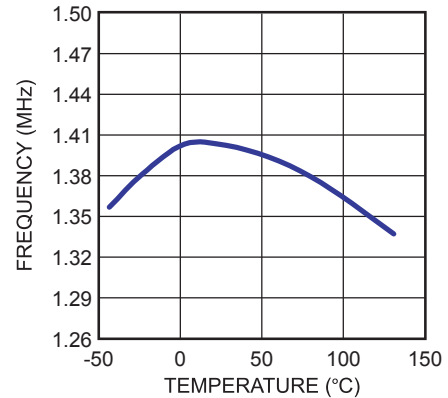
**Normal Operation**

**Load Transient on  $V_{MAIN}$** 

**Fault Timer**
 $V_{MAIN}$  Shorted to  $V_{IN}$ 

**Reference Voltage vs Temperature**

**Short Protection for Main Output**
 $V_{IN} = 5.5V$ ,  $I_{MAIN} = 0.35A$ ,  $I_{GH} = I_{GL} = 20mA$ 

**Oscillator Frequency vs Temperature**

### PRINTED CIRCUIT BOARD LAYOUT

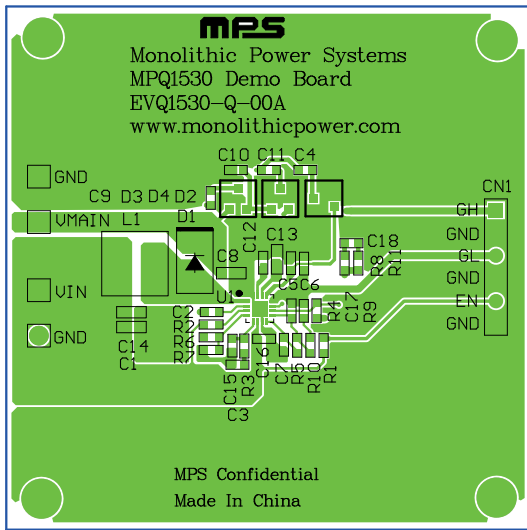

Figure 1: Top Layer & Top Silk Layer

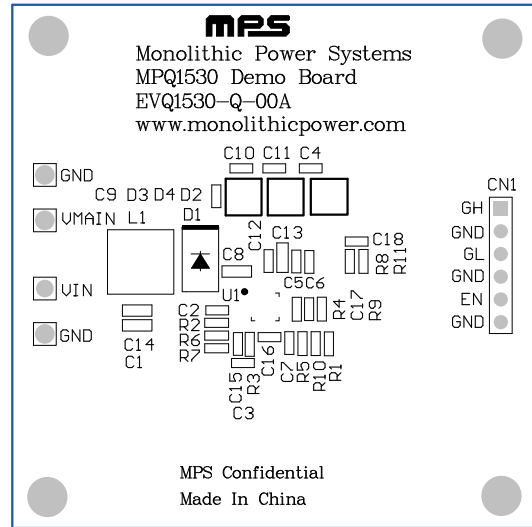

Figure 2: Top Silk Layer

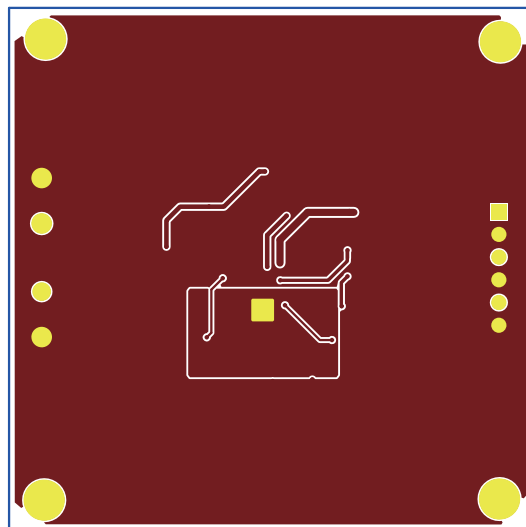

Figure 3: Bottom Layer

## QUICK START GUIDE

The three output voltages of this board are set to +13V, +27V, and –8.5V. The board layout accommodates most commonly used inductors and output capacitors.

1. Attach the positive end of loads to the VMAIN, VGH and GND (for the negative output) pins, respectively. Attach negative ends of the loads to GND and VGL (for the negative output) pins.
2. Attach an input voltage  $2.7V \leq V_{IN} \leq 5.5V$  and input ground to the VIN and GND pins, respectively.
3. The demo board starts up automatically once  $V_{IN}$  is applied due to the pull-up resistor R1. To disable the MPQ1530 connect the EN pin to ground.
4. During startup  $\overline{RDY}$  will be left HIGH. Once the turn-on sequence is complete, this pin will be pulled LOW if all regulators exceed 80% of their specified voltages. After all regulators are turned-on, a fault in any regulator will cause  $\overline{RDY}$  to go HIGH after approximately 15 $\mu$ s. If the fault persists for more than approximately 6ms (for  $C_T=10nF$ ), the entire chip will shut down.
5. To adjust the output voltages:

Use a 10k $\Omega$  to 50k $\Omega$  for the low-side resistor of each voltage divider (i.e. R7, R9 and R5).

$$V_{FB1} = V_{FB3} = V_{REF} = 1.25V.$$

For the step-up converter, determine the high-side resistor R6 using the equation:

$$R6 = \frac{V_{MAIN} - V_{FB1}}{\left(\frac{V_{FB1}}{R7}\right)}$$

Where  $V_{MAIN}$  is the output voltage of the step-up converter.

For the positive charge-pump, determine the high-side resistor R8 by the equation:

$$R8 = \frac{V_{GH} - V_{FB3}}{\left(\frac{V_{FB3}}{R9}\right)}$$

Where  $V_{GH}$  is the output voltage of the positive linear regulator. Determine the number of positive charge pump stages ( $N_{POS}$ ) by:

$$N_{POS} = \frac{V_{GH} + V_{DROPOUT} - V_{MAIN}}{V_{MAIN} - 2V_D}$$

Use  $V_{DROPOUT} = 1V$  and  $V_D = 0.4V$  for Schottky diodes.

For the negative charge-pump, determine the high-side resistor R4 by the equation:

$$R4 = \frac{-V_{GL}}{\left(\frac{V_{REF}}{R5}\right)}$$

Where  $V_{GL}$  is the output voltage of the negative linear regulator. Determine the number of negative charge pump stages ( $N_{NEG}$ ) by:

$$N_{NEG} = \frac{-V_{GL} + V_{DROPOUT}}{V_{MAIN} - 2V_D}$$

6. Use  $V_{DROPOUT} = 0.3V$  and  $V_D = 0.4V$  for Schottky diodes.

**NOTICE:** The information in this document is subject to change without notice. Please contact MPS for current specifications. Users should warrant and guarantee that third party Intellectual Property rights are not infringed upon when integrating MPS products into any application. MPS will not assume any legal responsibility for any said applications.