

DESCRIPTION

The EVM38111-R-00A Evaluation Board is designed to demonstrate the capabilities of MPS' MPM38111. The MPM38111 is a Dual Channels DC-DC Module. The module includes monolithic step-down switch mode converter with built-in internal power MOSFETs and inductors. It's designed to simplify power system design and provide ease of use.

The MPM38111 operates from a 2.7V-to-6V input, generates an output voltage as low as 0.608V, and has a 45µA quiescent current that makes it ideal for powering portable equipment that runs on a single cell lithium-ion (Li+) battery.

ELECTRICAL SPECIFICATION

Parameter	Symbol	Value	Units
Input Voltage	V_{IN}	2.7 – 6	V
Output Voltage	V_{OUT1}/V_{OUT2}	1.8/1.2	V
Output Current	I_{OUT1}/I_{OUT2}	1/1	A

FEATURES

- Dual 1A-Output Current
- >93% Peak Efficiency
- >80% Light-Load Efficiency
- Ultra Low IQ: 45µA
- 80mΩ and 40mΩ Internal Power MOSFET
- Wide 2.7V to 6V Operating Input Range
- Default 1MHz Switching Frequency
- 180° Phase-Shifted Operation
- 4mmx4mmx1.6mm QFN14 package
- 100% Duty Cycle Operation
- Cycle-by-Cycle Over-Current Protection
- Short Circuit Protection with Hiccup Mode
- Thermal Shutdown

APPLICATIONS

- Small/Handhold Devices
- DVD Drivers
- Portable Instruments
- Smart Phones and Feature Phones
- Battery-Powered Devices

All MPS parts are lead-free and adhere to the RoHS directive. For MPS green status, please visit MPS website under Products, Quality Assurance page. "MPS" and "The Future of Analog IC Technology" are registered trademarks of Monolithic Power Systems, Inc.

EVM38111-R-00A EVALUATION BOARD

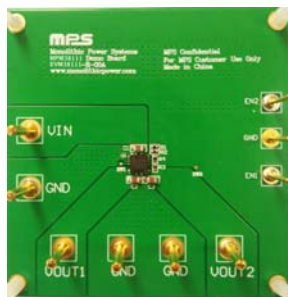

(L x W x H) 6.5cm x 6.5cm x 1.6cm

Board Number	MPS IC Number
EVM38111-R-00A	MPM38111

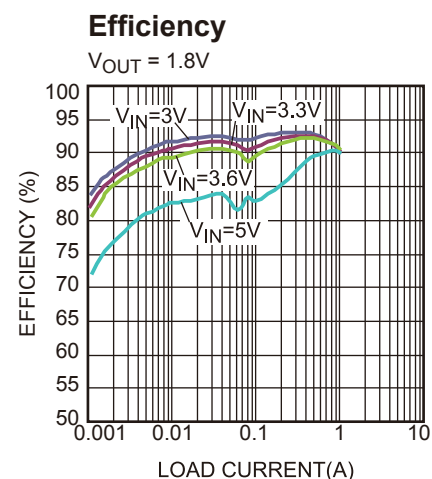

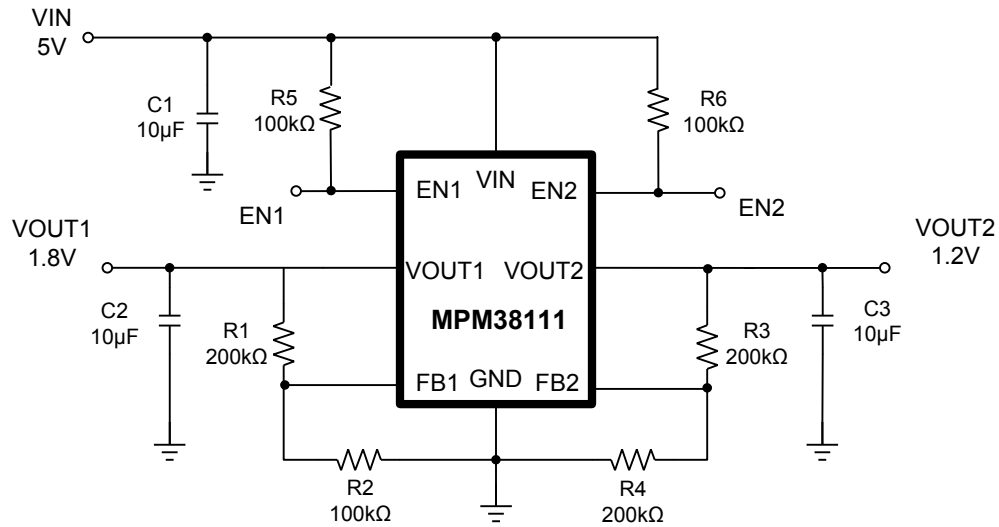
EVALUATION BOARD SCHEMATIC

EVM38111-R-00A BILL OF MATERIALS

Qty	Ref	Value	Description	Package	Manufacturer	Part Number
3	R1, R3, R4	200kΩ	Film Res,1%	0402	Any	
3	R2, R5, R6	100kΩ	Film Res,1%	0402	Any	
3	C1, C2, C3	10µF	Ceramic Cap,10V, X5R	0805	muRata	GRM21BR61A106KE19L

EVB TEST RESULTS

Performance waveforms are tested on the evaluation board.

$V_{IN} = 5V$, $V_{OUT1} = 1.8V$, $V_{OUT2} = 1.2V$, $C_{OUT1} = C_{OUT2} = 10\mu F$, $T_A = 25^\circ C$, unless otherwise noted.

Output Ripple

$I_{OUT1} = I_{OUT2} = 0A$

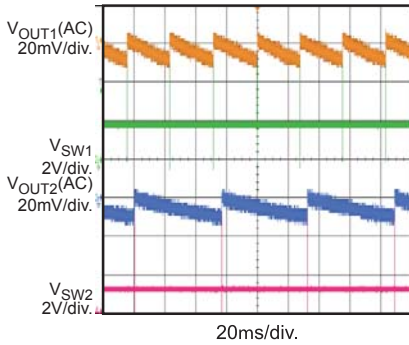

Output Ripple

$I_{OUT1} = I_{OUT2} = 1A$

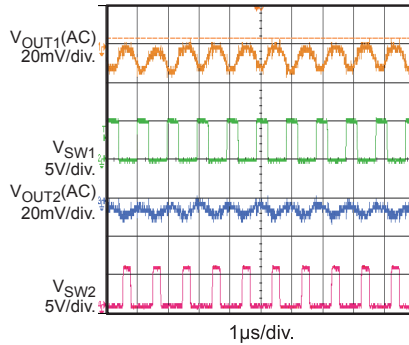

V_{IN} Power Up without Load

$I_{OUT1} = I_{OUT2} = 0A$

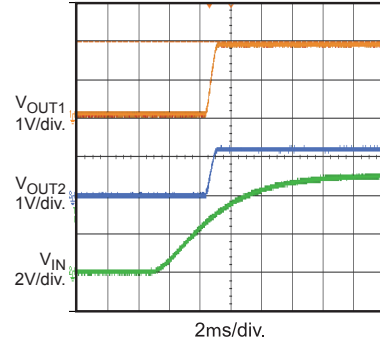

V_{IN} Power Up with 1A Load

$I_{OUT1} = I_{OUT2} = 1A$

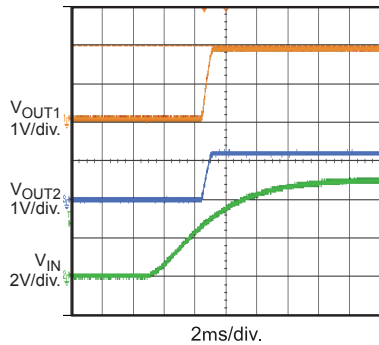

V_{IN} Power Down without Load

$I_{OUT1} = I_{OUT2} = 0A$

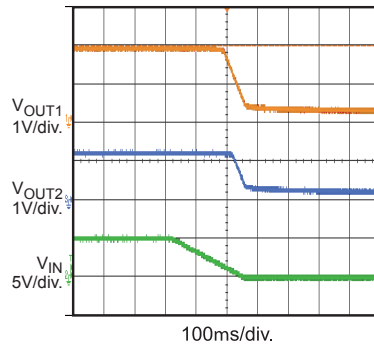

V_{IN} Power Down with 1A Load

$I_{OUT1} = I_{OUT2} = 1A$

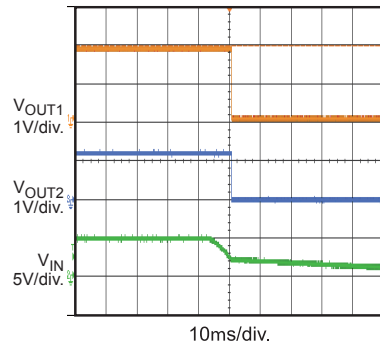

EN On without Load

$I_{OUT1} = I_{OUT2} = 0A$

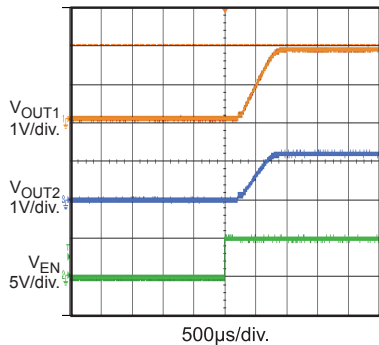

EN On with 1A Load

$I_{OUT1} = I_{OUT2} = 1A$

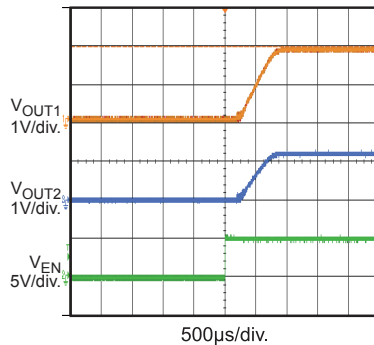

EN Down without Load

$I_{OUT1} = I_{OUT2} = 0A$

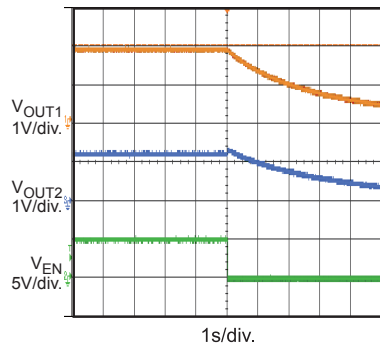

EVB TEST RESULTS (continued)

Performance waveforms are tested on the evaluation board.

$V_{IN} = 5V$, $V_{OUT1} = 1.8V$, $V_{OUT2} = 1.2V$, $C_{OUT1} = C_{OUT2} = 10\mu F$, $T_A = 25^\circ C$, unless otherwise noted.

EN Down with 1A Load
 $I_{OUT1} = I_{OUT2} = 1A$

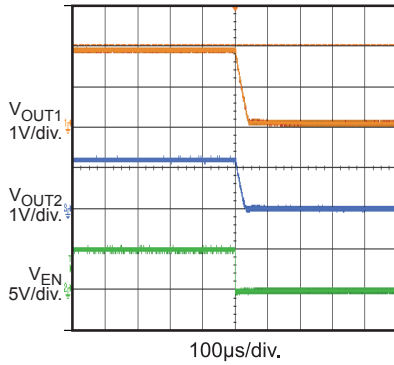

V_{IN} Power On without Load
 $I_{OUT1} = I_{OUT2} = 0A$

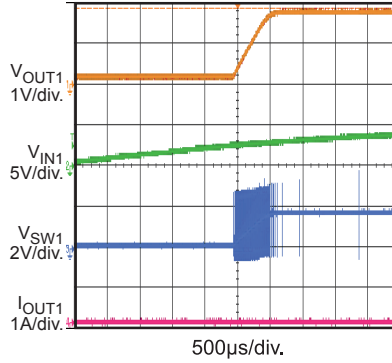

V_{IN} Power On with 1A Load
 $I_{OUT1} = 1A, I_{OUT2} = 0A$

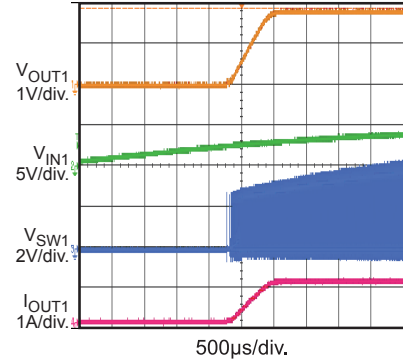

V_{IN} Power Down without Load
 $I_{OUT1} = I_{OUT2} = 0A$

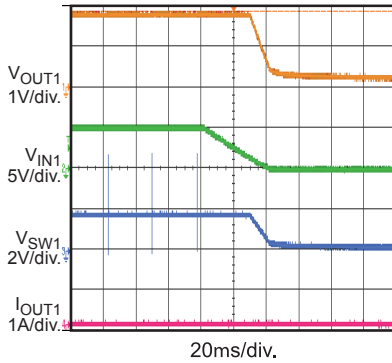

V_{IN} Power Down with 1A Load
 $I_{OUT1} = 1A, I_{OUT2} = 0A$

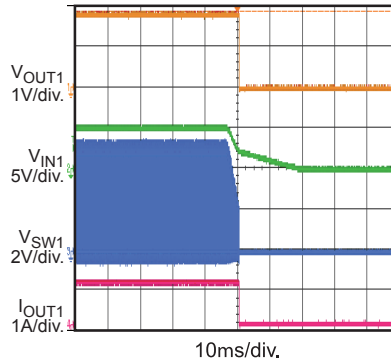

Enable On without Load
 $I_{OUT1} = I_{OUT2} = 0A$

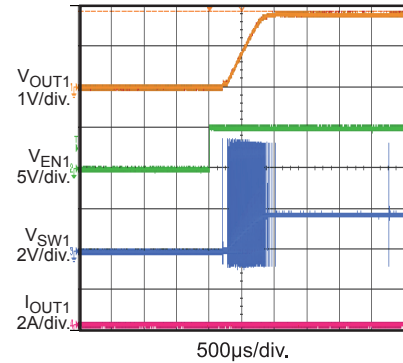

Enable On with 1A Load
 $I_{OUT1} = 1A, I_{OUT2} = 0A$

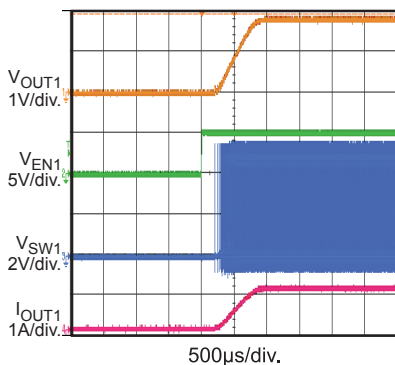

Enable Down without Load
 $I_{OUT1} = I_{OUT2} = 0A$

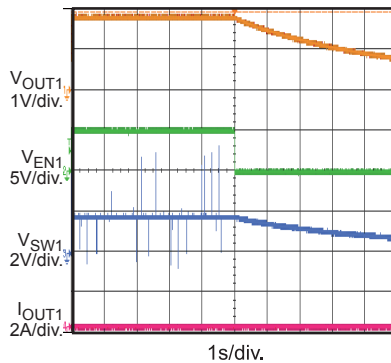

Enable Down with 1A Load
 $I_{OUT1} = 1A, I_{OUT2} = 0A$

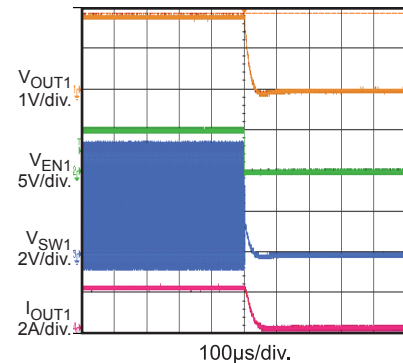

PRINTED CIRCUIT BOARD LAYOUT

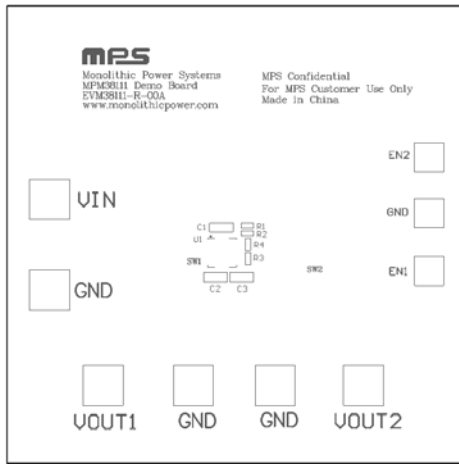

Figure 1—Top Silk Layer

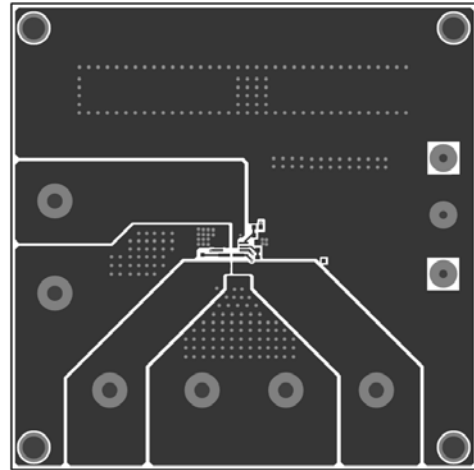

Figure 2—Top Layer

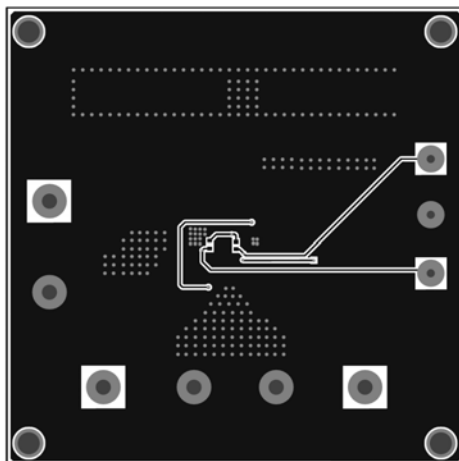

Figure 3—Bottom Layer

QUICK START GUIDE

The output voltage of this board is set externally by operating from +2.7V to +6V input. The default output voltage of this board is set to $V_{OUT1}=1.8V$, $V_{OUT2}=1.2V$.

1. Preset Power Supply to $2.7V \leq V_{IN} \leq 6V$.
2. Turn Power Supply off.
3. Connect Power Supply terminals to:
 - a. Positive (+): V_{IN}
 - b. Negative (-): GND
4. Connect Load to:
 - a. Positive (+): V_{OUT1}
 - b. Negative (-): GND
 - c. Positive (+): V_{OUT2}
 - d. Negative (-): GND
5. Turn Power Supply on after making connections.
6. To enable the MPM38111, apply a voltage, $1.2V \leq V_{EN} \leq 6V$, to the EN pin. To disable the MPM38111, apply a voltage, $V_{EN} < 0.4V$, to the EN pin. The EN pin can be connected to V_{IN} with a 100k Ω resistor for automatic startup.
7. The output voltage V_{OUT} can be changed by varying R1. Calculate the new value by formula:

$$R2 = \frac{R1}{\frac{V_{OUT}}{0.608V} - 1}$$

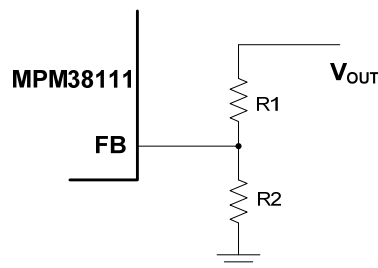

Figure 4

NOTICE: The information in this document is subject to change without notice. Please contact MPS for current specifications. Users should warrant and guarantee that third party Intellectual Property rights are not infringed upon when integrating MPS products into any application. MPS will not assume any legal responsibility for any said applications.