



The Future of Analog IC Technology®

EVM3811-G-00A

High Efficiency, 1A, 5.5V,
2.2 MHz Synchronous Step-down Switcher
with Integrated Inductor

DESCRIPTION

The MPM3811 is a monolithic step-down switch mode converter with built-in power MOSFETs and inductor. The DC-DC module has a small surface mount 2mm x 2mm QFN package. It achieves 1A continuous output current from a 2.3V to 5.5V input voltage with excellent load and line regulation. The MPM3811 is ideal for a wide range of applications including high performance DSPs, wireless power, portable and mobile Devices, and other low-power systems. The output voltage can be regulated as low as 0.6V. Only input, output capacitors and FB resistors are needed to complete the design.

The Constant-On-time (COT) control scheme provides fast transient response, high efficiency at light-load and easy loop compensation.

The MPM3811 features fault protection functions including cycle-by-cycle current limit and thermal shutdown.

The MPM3811 requires a minimum number of readily available standard external components and is available in an ultra-small QFN10 (2mmx2mmx1.6mm) package.

ELECTRICAL SPECIFICATION

Parameter	Symbol	Value	Units
Input Voltage	V _{IN}	2.3 – 5.5	V
Output Voltage	V _{OUT}	1.2	V
Output Current	I _{OUT}	1	A

Note: V_{IN}<3.3V may need more input capacitor.

FEATURES

- Up to 91% Peak Efficiency
- Wide 2.3V to 5.5V Operating Input Range
- Output Voltage as Low as 0.6V
- 100% Duty Cycle in Dropout
- 1A Output Current
- 120mΩ and 80mΩ Internal Power MOSFET.
- 2.2MHz Frequency
- EN for Power Sequencing
- Cycle-by-Cycle Over Current Protection
- 0.5ms Internal Soft-Start Time
- Output Discharge
- Short Circuit Protection with Hiccup Mode
- Thermal Shutdown
- Stable with Low ESR Output Ceramic Capacitors
- Available in a QFN10 (2mmx2mmx1.6mm) Package

APPLICATIONS

- Wireless/Networking Cards
- Portable and Mobile Devices
- Battery Powered Devices
- Low Voltage I/O System Power

All MPS parts are lead-free, halogen free, and adhere to the RoHS directive. For MPS green status, please visit MPS website under Quality Assurance.

"MPS" and "The Future of Analog IC Technology" are Registered Trademarks of Monolithic Power Systems, Inc.

EVM3811-G-00A EVALUATION BOARD



Board Number	MPS IC Number
EVM3811-G-00A	MPM3811GG

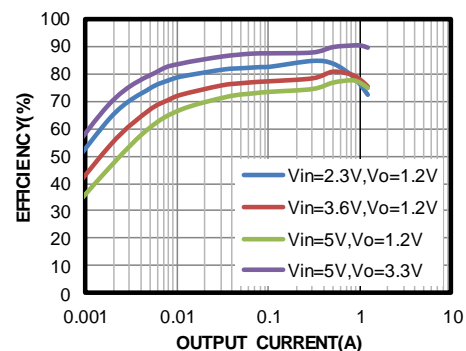

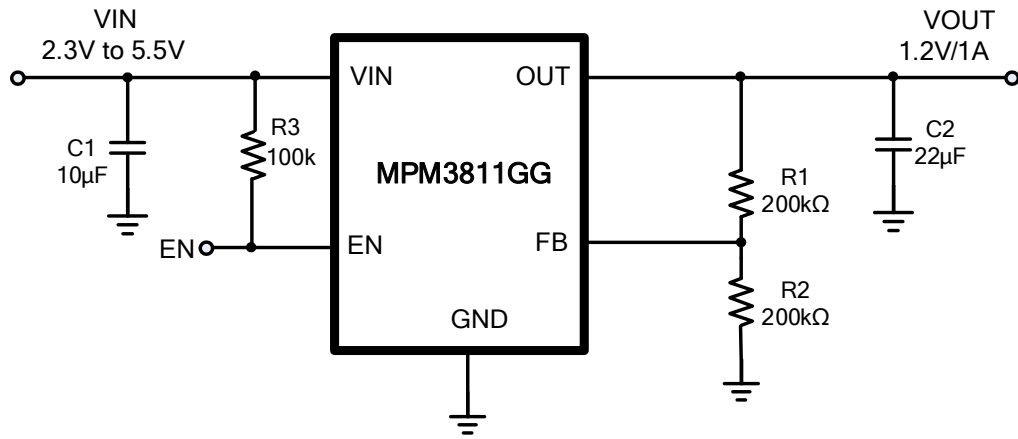
EVALUATION BOARD SCHEMATIC

Figure 1—Schematic of EVM3811GG

 Note: $V_{IN} < 3.3V$ may need more input capacitor.

EVM3811-G-00A BILL OF MATERIALS

Qty	RefDes	Value	Description	Package	Manufacturer	Manufacturer P/N
2	R1, R2	200kΩ	Film Res,1%	0402	Any	Any
1	R3	100kΩ	Film Res,1%	0402	Any	Any
1	C1	10µF	Ceramic Cap,6.3V,X5R	0603	muRata	GRM188R60J475KE19D
1	C2	22µF	Ceramic Cap,6.3V,X5R	0603	TDK	C1608X5R0J226M
1	U1	MPM3811		2mmx2mm	MPS	MPM3811GG

EVB TEST RESULTS

Performance waveforms are tested on the evaluation board.

$V_{IN} = 5V$, $V_{OUT} = 1.2V$, $C_o = 22\mu F$, $T_A = +25^\circ C$, unless otherwise noted.

Steady State

$I_{OUT} = 0A$

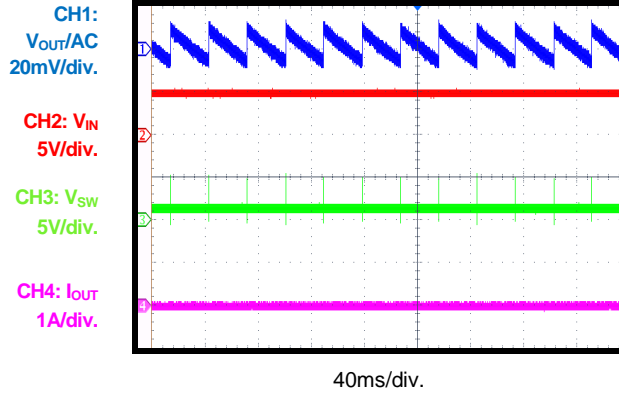

Steady State

$I_{OUT} = 1A$

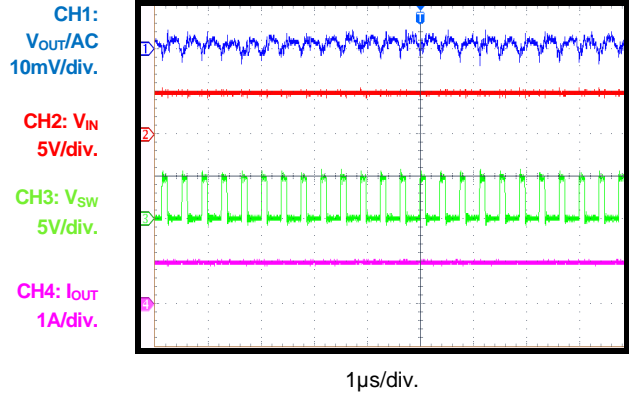

Transient

$I_{OUT} = 0A-1A$

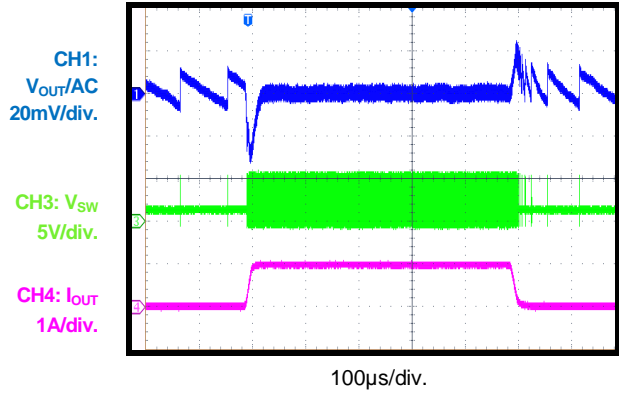

Transient

$I_{OUT} = 0.5A-1A$

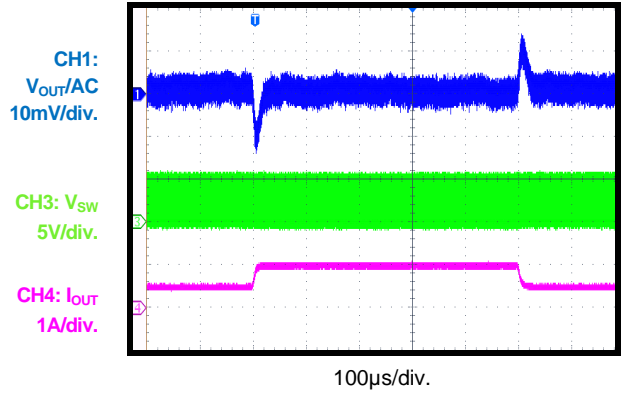

EN ON

$I_{OUT} = 0A$

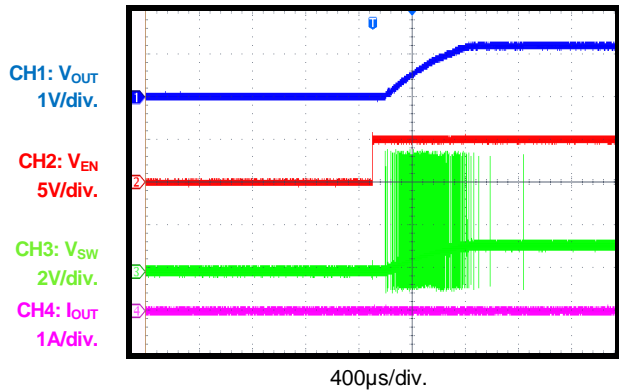

EN ON

$I_{OUT} = 1A$

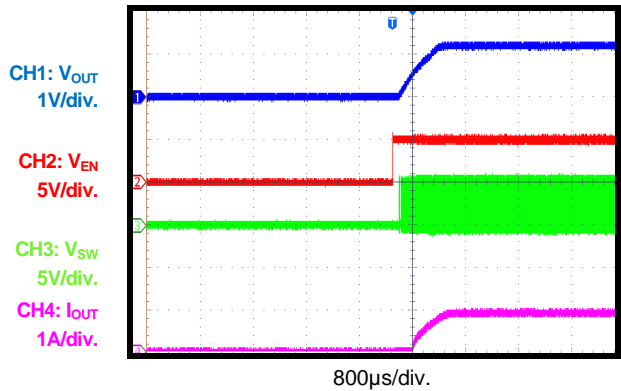

EVB TEST RESULTS (continued)

Performance waveforms are tested on the evaluation board.

$V_{IN} = 5V$, $V_{OUT} = 1.2V$, $C_o = 22\mu F$, $T_A = +25^\circ C$, unless otherwise noted.

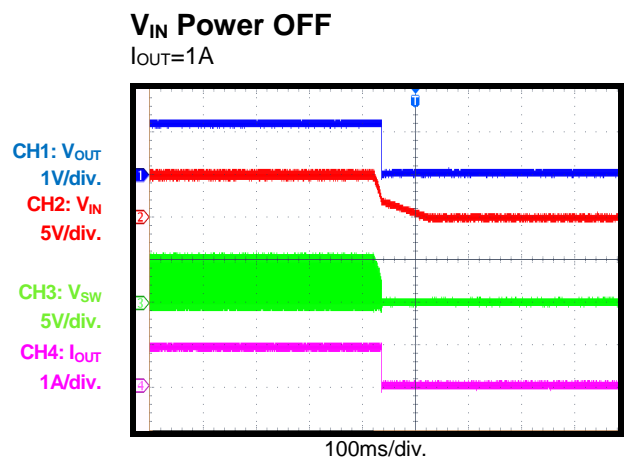
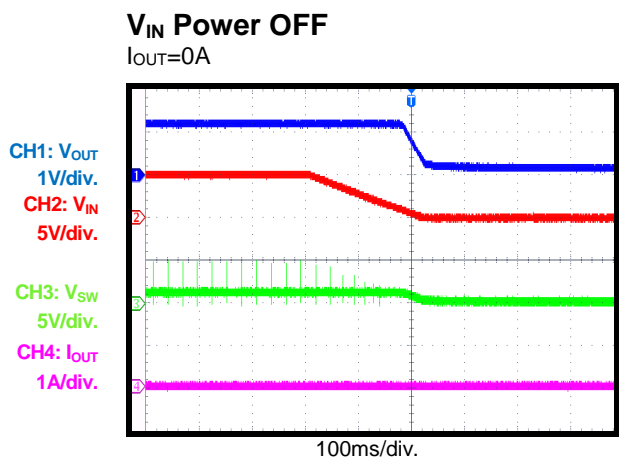
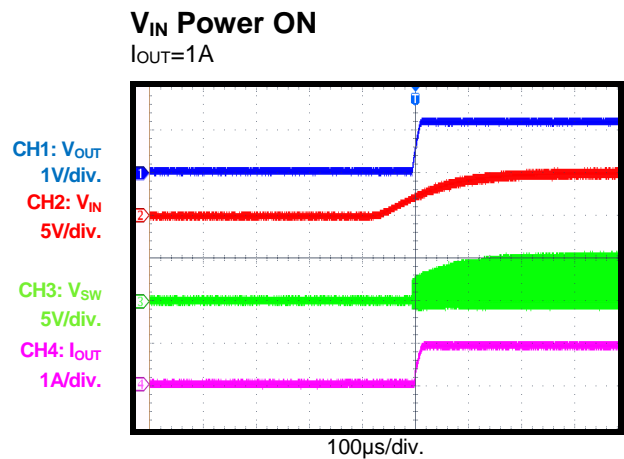
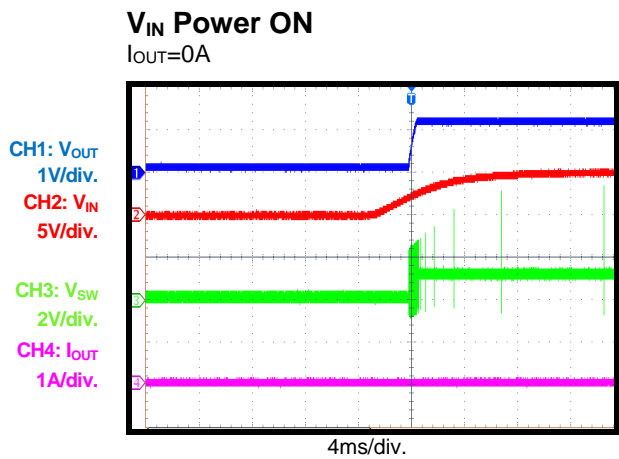
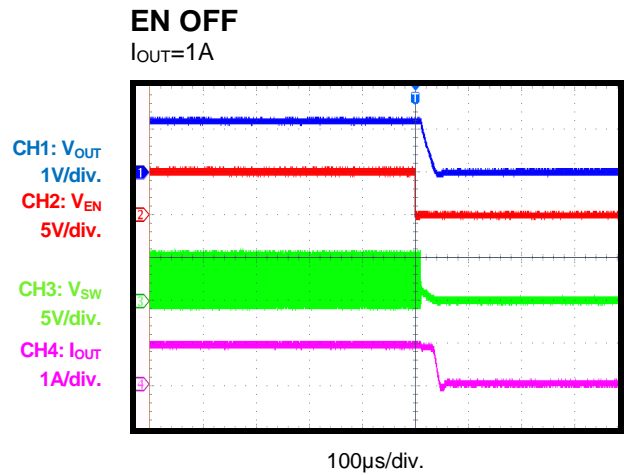
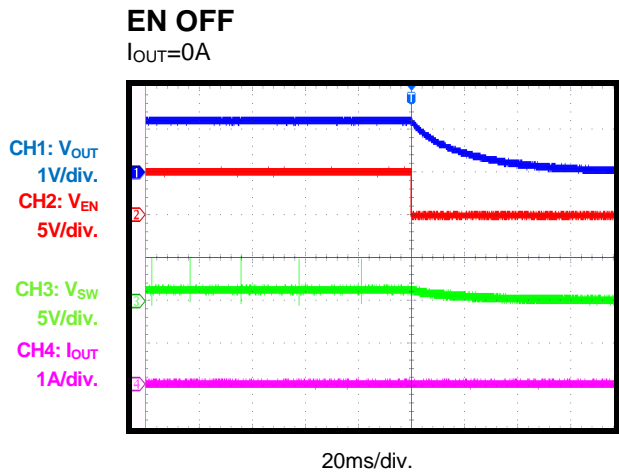

EVB TEST RESULTS (continued)

Performance waveforms are tested on the evaluation board.

$V_{IN} = 5V$, $V_{OUT} = 1.2V$, $L = 1.0\mu H$, $C_o = 22\mu F$, $T_A = +25^\circ C$, unless otherwise noted.

Short Circuit Entry

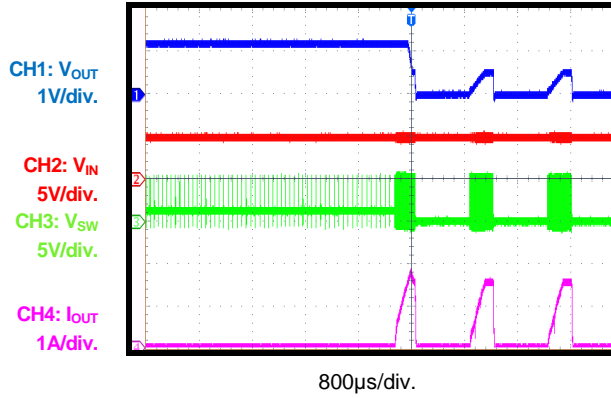

Short Circuit Steady

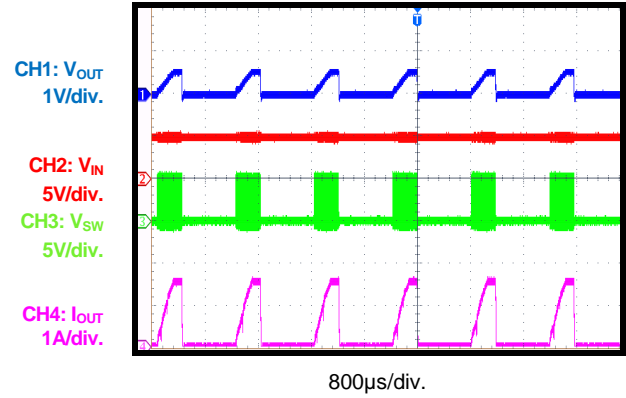

Short Circuit Recovery

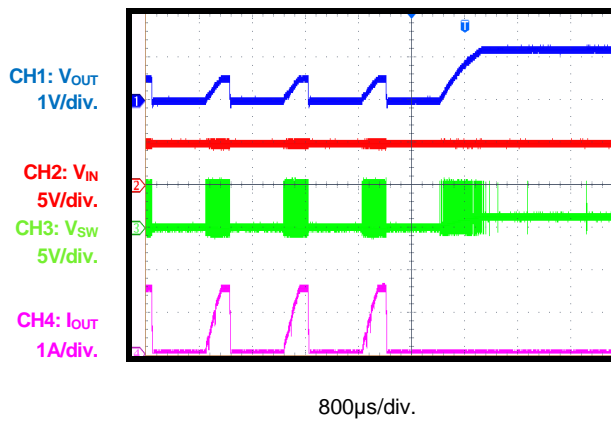

PRINTED CIRCUIT BOARD LAYOUT

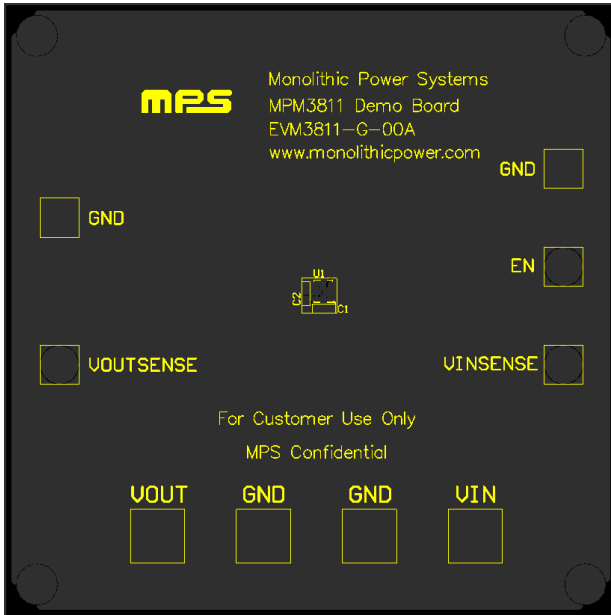

Figure 2—Top Silk Layer

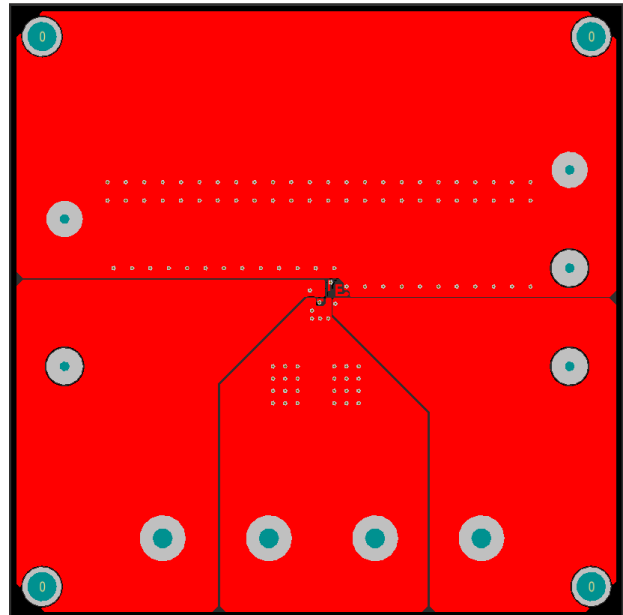

Figure 3—Top Layer

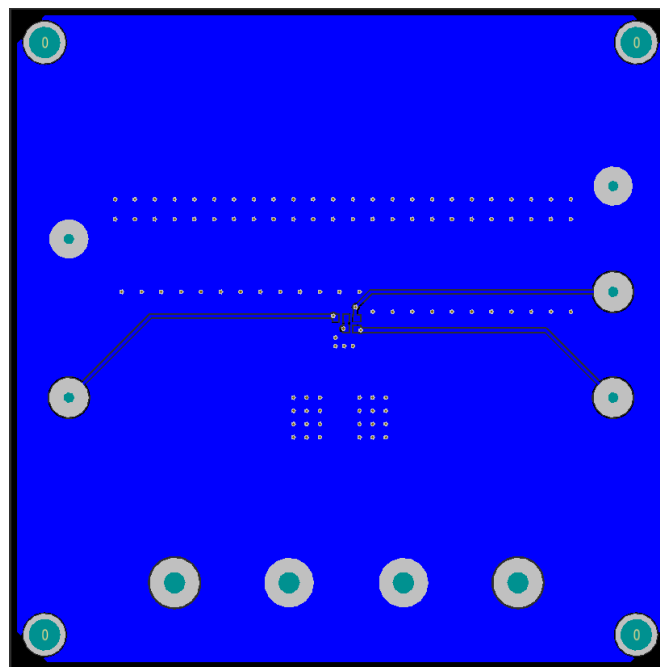

Figure 4—Bottom Layer

QUICK START GUIDE

The output voltage of this board is set externally which can be regulated as low as 0.6V by operating from +2.3V to +5.5V input as the Figure 1. The default output voltage of this board is set to 1.2V.

1. Connect the positive and negative terminals of the load to the VOUT and GND pins, respectively.
2. Preset the power supply output between 2.3V and 5.5V, and then turn off the power supply.
3. Connect the positive and negative terminals of the power supply output to the VIN and GND pins, respectively.
4. Turn the power supply on. The board will automatically start up.
5. The Output Voltage can be changed by varying R2. Choose R1 to be around 40kΩ to 200kΩ. R2 is then given by:

$$R2 = \frac{R1}{\frac{V_{out}}{0.6} - 1}$$

Example: For Vout= 1.8V, R1=200kΩ, R2=100kΩ.

6. For fixed output version, just need replace IC and remove the feedback resistor R1&R2.

NOTICE: The information in this document is subject to change without notice. Please contact MPS for current specifications. Users should warrant and guarantee that third party Intellectual Property rights are not infringed upon when integrating MPS products into any application. MPS will not assume any legal responsibility for any said applications.