

### DESCRIPTION

The EVM3632C-QV-00B Evaluation Board is designed to demonstrate the capabilities of MPS' MPM3632C, a step-down regulator module integrated with a synchronous, rectifying power MOSFET, inductor, and three capacitors. The MPM3632C offers a very compact solution that requires only input and output capacitors to achieve 3A of continuous output current with excellent load and line regulation over a wide input range.

The MPM3632C operates at a fixed 3MHz switching frequency and employs constant-on-time (COT) control, which provides a fast load transient response.

Full protection features include output over-voltage protection (OVP), over-current protection (OCP), and thermal shutdown.

The MPM3632C is available in a space-saving QFN-20 (3mmx5mmx1.6mm) package.

### ELECTRICAL SPECIFICATION

Parameter	Symbol	Value	Units
Input Voltage	$V_{IN}$	12	V
Output Voltage	$V_{OUT}$	3.3	V
Output Current	$I_{OUT}$	3	A

### FEATURES

- Complete Switch-Mode Power Supply
- 3MHz Switching Frequency
- Wide 4V to 18V Operation Input Range
- Output Adjustable from 0.8V
- Internal Fixed Soft-Start Time
- 3A Continuous Output Current
- Forced CCM for Low Output Ripple
- Power Good Indicator (PG)
- Hiccup Over-Current Protection (OCP)
- Output Over-Voltage Protection (OVP)
- Thermal Shutdown
- Fast Transient Response
- Available in a QFN-20 (3mmx5mmx1.6mm) Package
- Total Solution Size: 7mmx7.9mm

### APPLICATIONS

- Server Systems
- Medical and Imaging Equipment
- Distributed Power Systems
- Point of Load for FPGA, ASICs, DSPs
- Space Constrained Applications

All MPS parts are lead-free, halogen free, and adhere to the RoHS directive. For MPS green status, please visit MPS website under Quality Assurance.

"MPS" and "The Future of Analog IC Technology" are Registered Trademarks of Monolithic Power Systems, Inc.

### EVM3632C-QV-00A EVALUATION BOARD



(L x W x H) 64mm x 64mm x 1.6mm

Board Number	MPS IC Number
EVM3632C-QV-00B	MPM3632CGQV

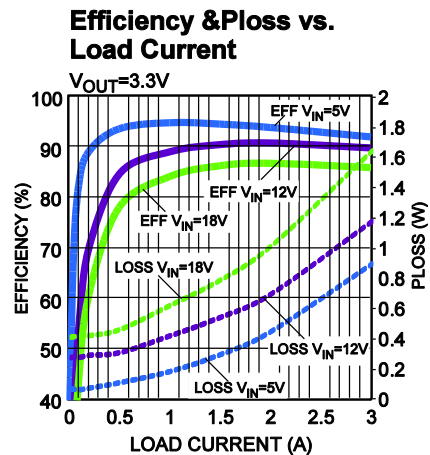

## EVALUATION BOARD SCHEMATIC

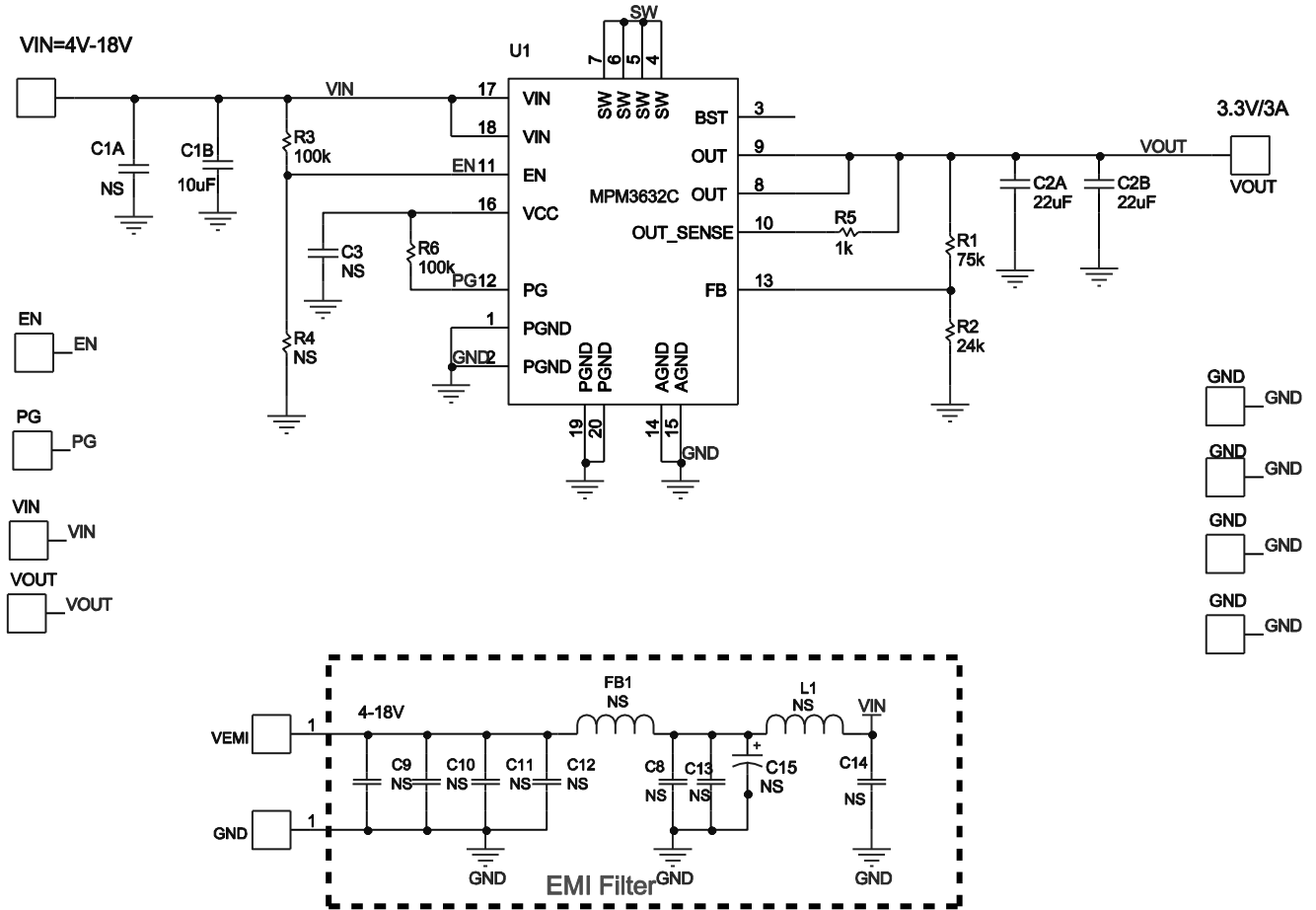

## EVM3632C-QV-00B BILL OF MATERIALS

Qty	Designator	Value	Description	Package	Manufacturer	Manufacturer P/N
1	C1B	10μF	Ceramic Cap.,25V,X5R	0805	Murata	GRM21BR61E106MA73L
2	C2A,C2B	22μF	Ceramic Cap.,16V,X5R	0805	TDK	C2012X5R1C226K
1	R1	75k	Film Res,1%,0402,75K	0402	YAGEO	RC0402FR-0775KL
1	R2	24K	Film Res,1%,0402,24K	0402	YAGEO	RC0402FR-0724KL
1	R5	1k	Film Res,1%,0402,1K	0402	YAGEO	RC0402FR-0711KL
2	R3,R6	100k	Film Res,1%,0402,100K	0402	YAGEO	RC0402FR-07100KL

## EVB TEST RESULTS

Performance waveforms are tested on the evaluation board.

$V_{IN} = 12V$ ,  $V_{OUT} = 3.3V$ ,  $T_A = 25^\circ C$ , unless otherwise noted.

**Output Ripple**

$I_{OUT}=0A$

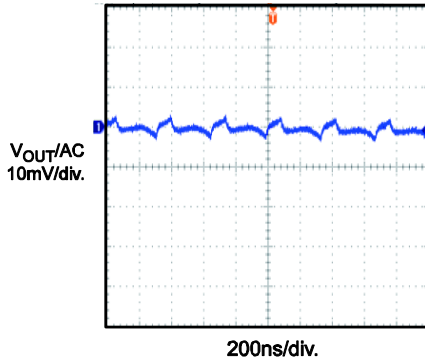

**Output Ripple**

$I_{OUT}=3A$

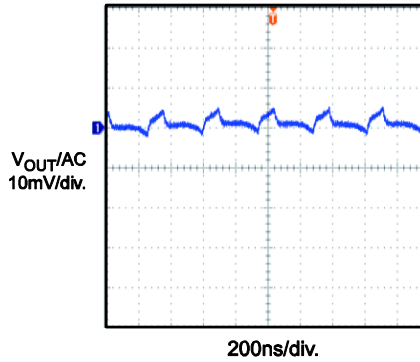

**Input vs. Output Ripple**

$I_{OUT}=3A$ ,  $C_{IN}=10\mu F$ , Probe BW=20MHz

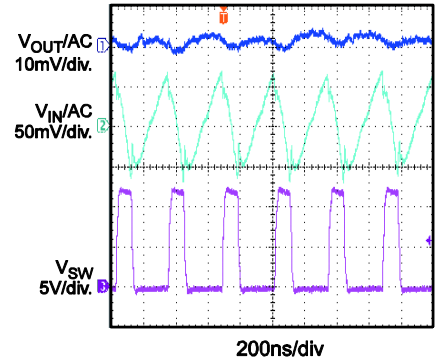

**Start-Up through Input Voltage**

$I_{OUT}=0A$

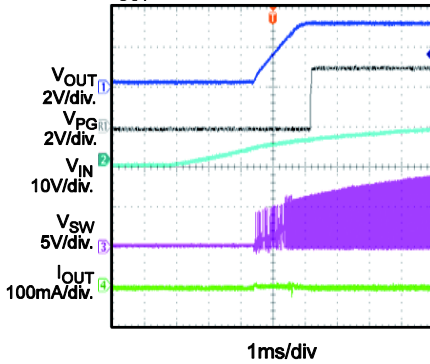

**Start-Up through Input Voltage**

$I_{OUT}=3A$

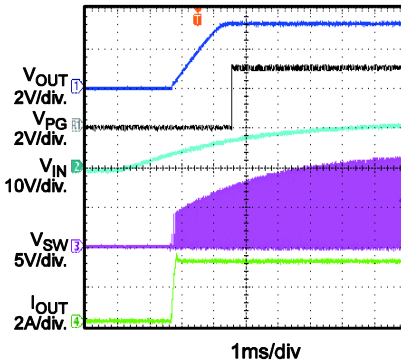

**Shutdown through Input Voltage**

$I_{OUT}=0A$

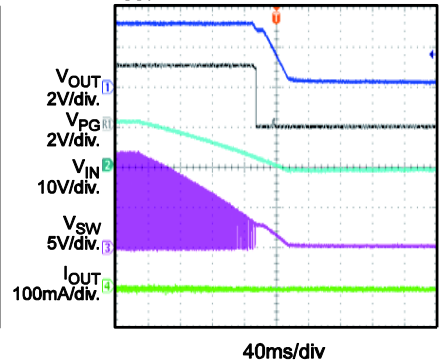

**Shutdown through Input Voltage**

$I_{OUT}=3A$

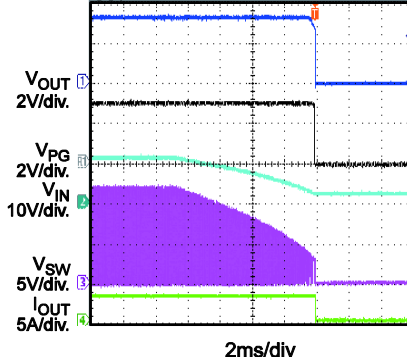

**Start-Up through EN**

$I_{OUT}=0A$

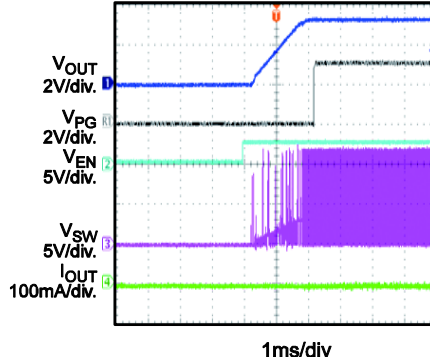

**Start-Up through EN**

$I_{OUT}=3A$

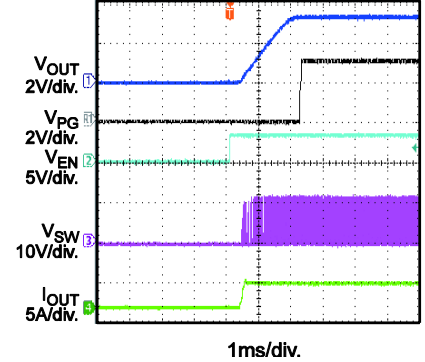

**EVB TEST RESULTS (continued)**

Performance waveforms are tested on the evaluation board.  
 $V_{IN} = 12V$ ,  $V_{OUT} = 3.3V$ ,  $T_A = 25^\circ C$ , unless otherwise noted.

**Shutdown through EN**  
 $I_{OUT} = 0A$

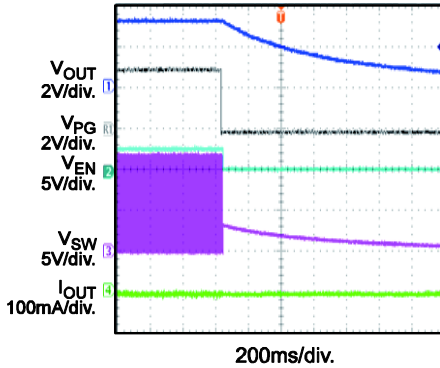

**Shutdown through EN**  
 $I_{OUT} = 3A$

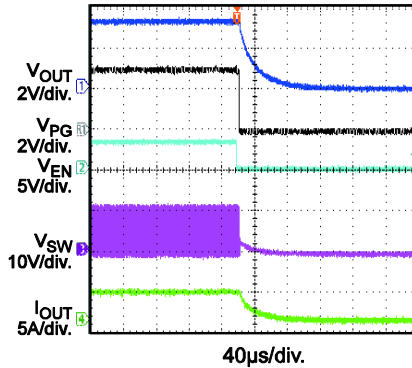

**Response to Load Transient**  
 $I_{OUT} = 0A - 1.5A, 2.5A/\mu s$

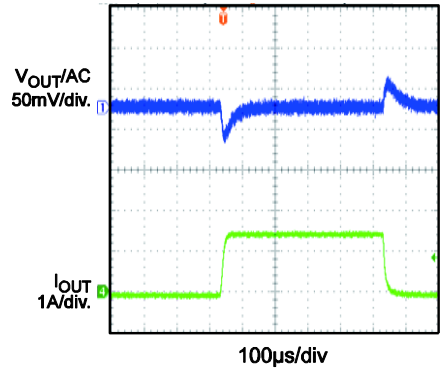

**Response to Load Transient**  
 $I_{OUT} = 1.5A - 3A, 2.5A/\mu s$

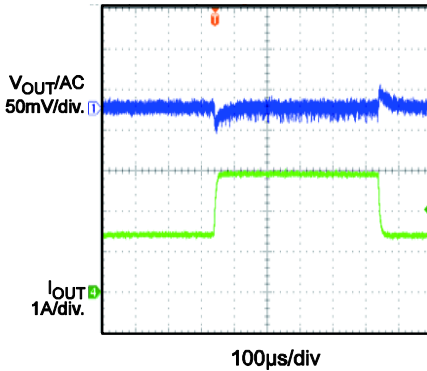

**VOUT Short Protection**  
 $I_{OUT} = 0A$

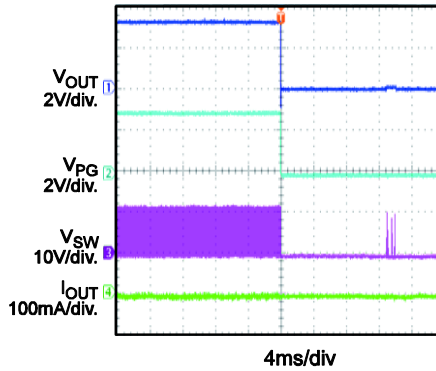

**Steady State of Short Protection**  
 Apply Short on  $V_{OUT}$

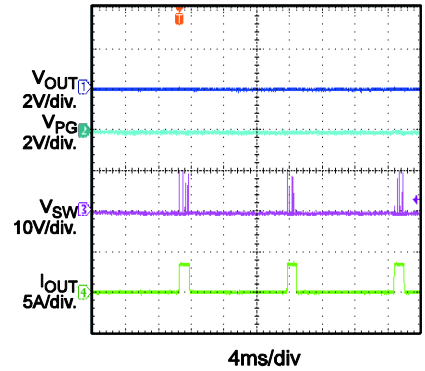

**Recover from VOUT Short**  
 $I_{OUT} = 0A$

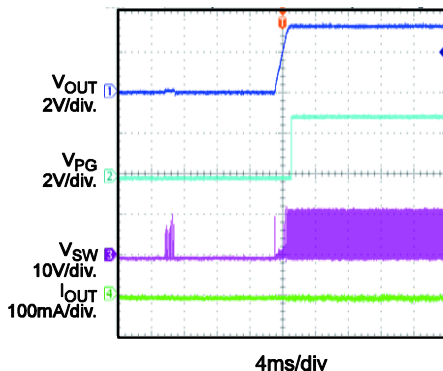

## PRINTED CIRCUIT BOARD LAYOUT

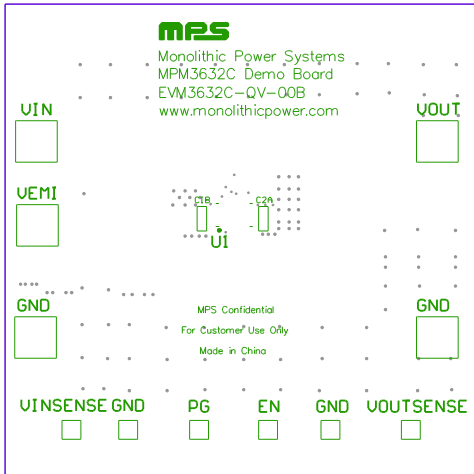

Figure 1: Top Silk Layer

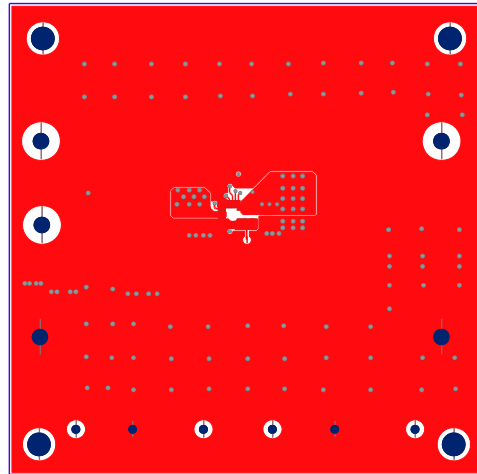

Figure 2: Top Layer

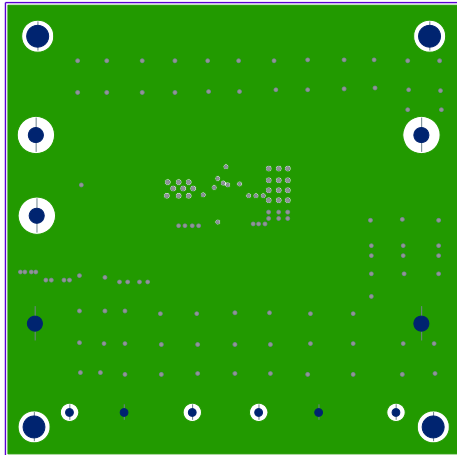

Figure 3: Mid Layer1

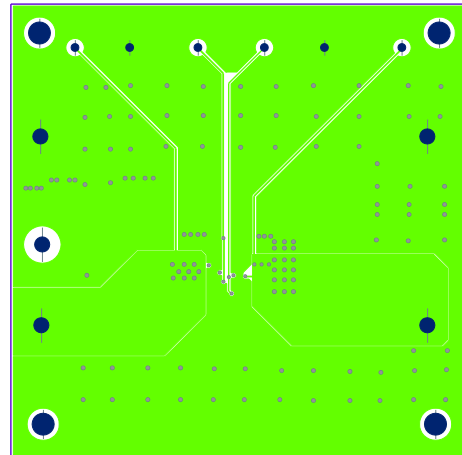

Figure 4: Mid Layer2

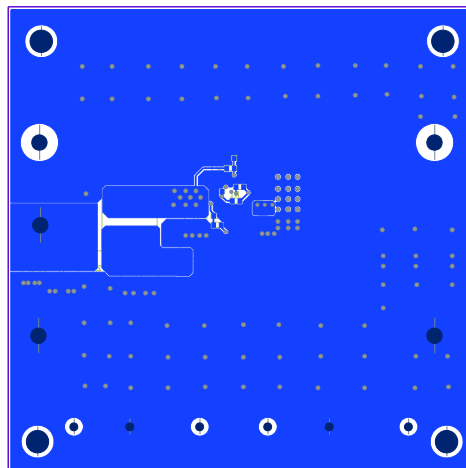

Figure 5: Bottom Layer

## QUICK START GUIDE

1. Preset Power Supply to  $4V \leq V_{IN} \leq 18V$ .
2. Turn Power Supply off.
3. Connect Power Supply terminals to:
  - a. Positive (+): VIN
  - b. Negative (-): GND
4. Connect Load to:
  - a. Positive (+): VOUT
  - b. Negative (-): GND
5. Turn Power Supply on after making connections. The board will automatically start up.

**NOTICE:** The information in this document is subject to change without notice. Please contact MPS for current specifications. Users should warrant and guarantee that third party Intellectual Property rights are not infringed upon when integrating MPS products into any application. MPS will not assume any legal responsibility for any said applications.