

DESCRIPTION

The MPM3630 is a synchronous rectified, step-down Module converter with built-in power MOSFETs, inductor and two capacitors.

The Evaluation Board can deliver a 3A continuous output current with excellent load and line regulation over a wide input supply range.

Full protection features include over-current protection and thermal shut down.

The MPM3630 is available in a space-saving QFN20 (3mm x5mmx1.6mm) package.

ELECTRICAL SPECIFICATION

Parameter	Symbol	Value	Units
Input Voltage	V_{IN}	5 – 18	V
Output Voltage	V_{OUT}	3.3	V
Output Current	I_{OUT}	3	A

FEATURES

- Complete Switch Mode Power Supply
- 4.5V-to-18V Wide Operating Input Range
- 3A Continuous Load Current
- 50mΩ/22mΩ Low RDS(ON) Internal Power MOSFETs
- Integrated Inductor
- Fixed 1.4MHz Switching Frequency
- 1MHz-2MHz Frequency Sync
- Power Save Mode for Light Load
- Power Good Indicator
- OCP Protection and Hiccup
- Thermal Shutdown
- Output Adjustable from 0.6V
- Available in QFN20 (3x5x1.6mm) Package

APPLICATIONS

- Industrial Controls
- Medical and Imaging Equipment
- Telecom Applications
- LDO Replacement
- Space and Resource-Limited Application
- Distributed Power Systems

All MPS parts are lead-free, halogen free, and adhere to the RoHS directive. For MPS green status, please visit MPS website under Quality Assurance.

"MPS" and "The Future of Analog IC Technology" are Registered Trademarks of Monolithic Power Systems, Inc.

EVM3630-QV-00A EVALUATION BOARD



Board Number	MPS IC Number
EVM3630-QV-00A	MPM3630GQV

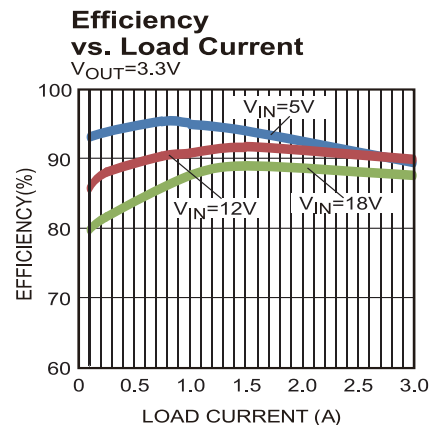

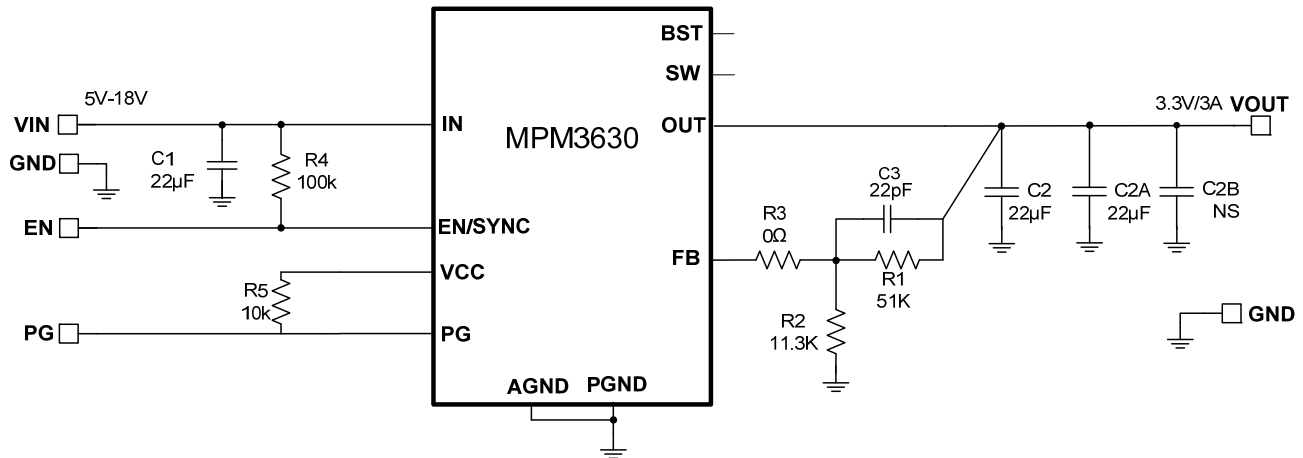
EVALUATION BOARD SCHEMATIC

Note: If V_{in} is lower than 5V, to avoid BST voltage insufficient, need add schottky diode from VCC to BST.

EVM3630-QV-00A BILL OF MATERIALS

Qty	RefDes	Value	Description	Package	Manufacturer	Manufacturer P/N
1	C1	22µF	Ceramic Cap, 25V,X5R	0805	muRata	GRM21BR61E226ME44L
2	C2,C2A	22uF	Ceramic Cap,16V,X5R	0805	muRata	GRM219R61C226ME15L
1	C2B	NS				
1	C3	22pF	Ceramic Cap,50V,C0G	0402	muRata	GRM1555C1H220JA01
1	R2	11.3k	Thick Film Res., 1%	0402	Any	
1	R1	51k	Thick Film Res., 1%	0402	Any	
1	R3	0	Thick Film Res., 1%	0402	Any	
1	R4	100k	Thick Film Res., 1%	0402	Any	
1	R5	10k	Thick Film Res., 1%	0402	Any	
1	U1	MPM3630	Synchronous Step-Down Module	QFN-20	MPS	MPM3630GQV

EVB TEST RESULTS

Performance waveforms are tested on the evaluation board.

$V_{IN} = 12V$, $V_{OUT} = 3.3V$, $T_A = 25^\circ C$, unless otherwise noted.

Output Ripple

$I_{OUT} = 0A$

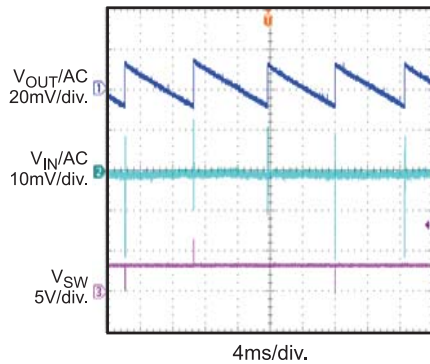

Output Ripple

$I_{OUT} = 3A$

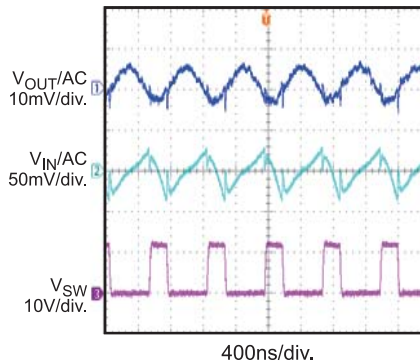

Start-Up through Input Voltage

$I_{OUT} = 0A$

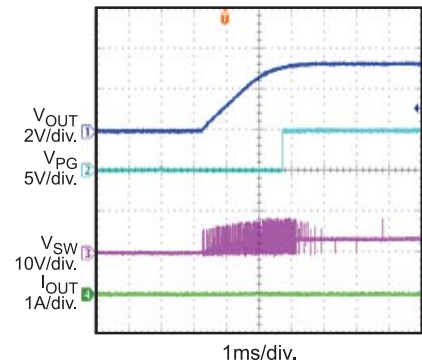

Start-Up through Input Voltage

$I_{OUT} = 3A$

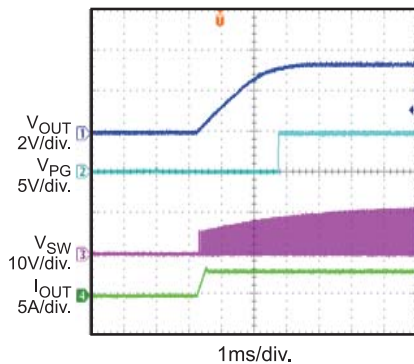

Shutdown through Input Voltage

$I_{OUT} = 0A$

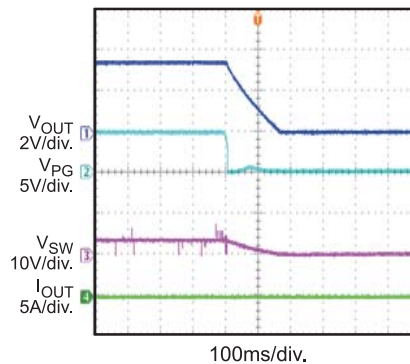

Shutdown through Input Voltage

$I_{OUT} = 3A$

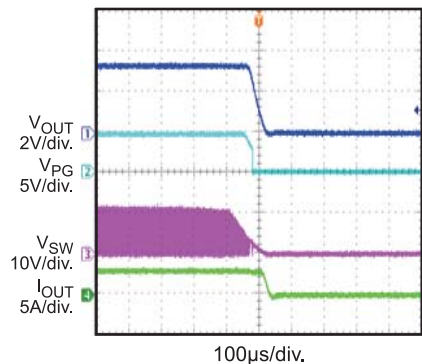

Start-Up through Enable

$I_{OUT} = 0A$

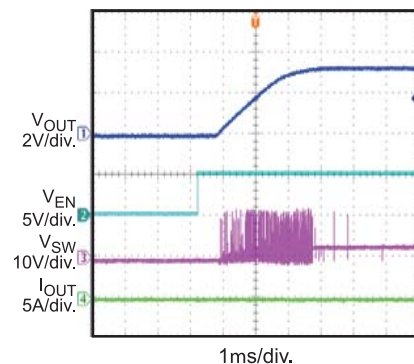

Start-Up through Enable

$I_{OUT} = 3A$

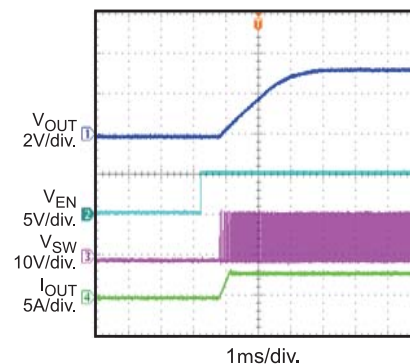

Shutdown through Enable

$I_{OUT} = 0A$

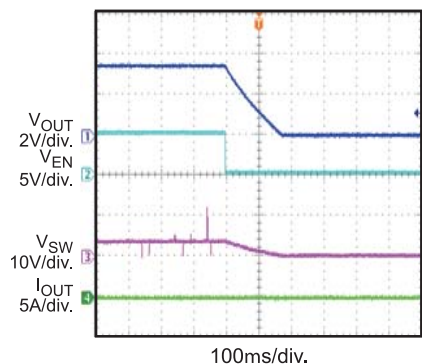

EVB TEST RESULTS

Performance waveforms are tested on the evaluation board.

$V_{IN} = 12V$, $V_{OUT} = 3.3V$, $T_A = 25^\circ C$, unless otherwise noted.

Shutdown through Enable

$I_{OUT} = 3A$

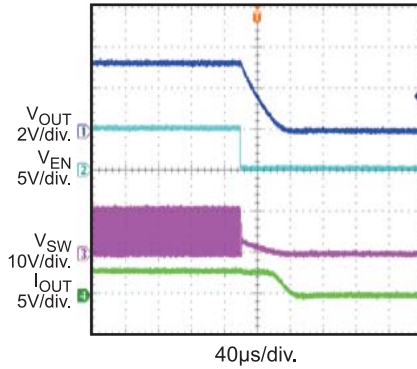

Load Transient Response

I_{OUT} transient from 1.5A to 3A

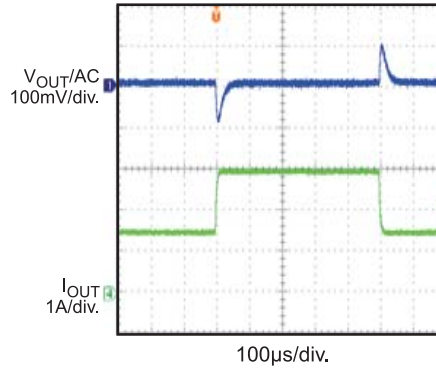

Short-Circuit Steady State

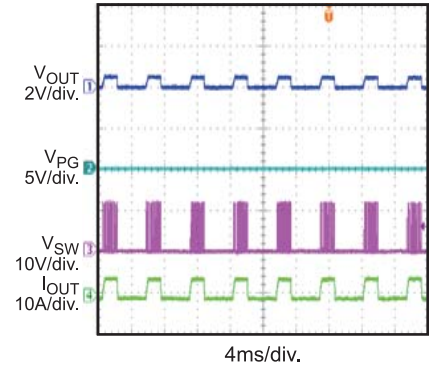

Short-Circuit Entry

$I_{OUT} = 0A$

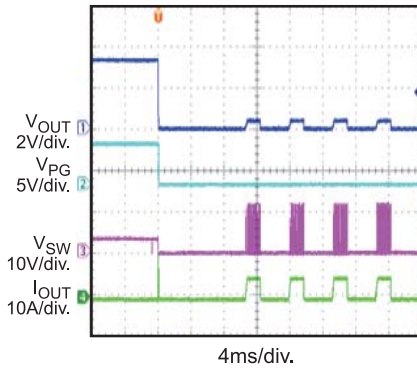

Short-Circuit Recovery

$I_{OUT} = 0A$

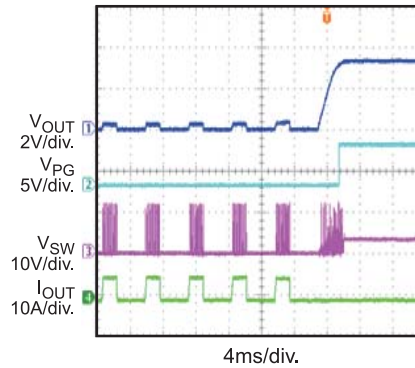

PRINTED CIRCUIT BOARD LAYOUT

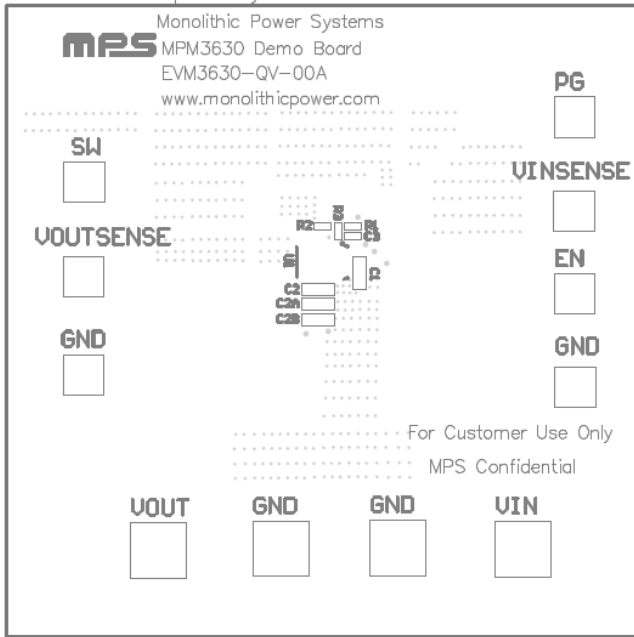

Figure 1—Top Silk Layer

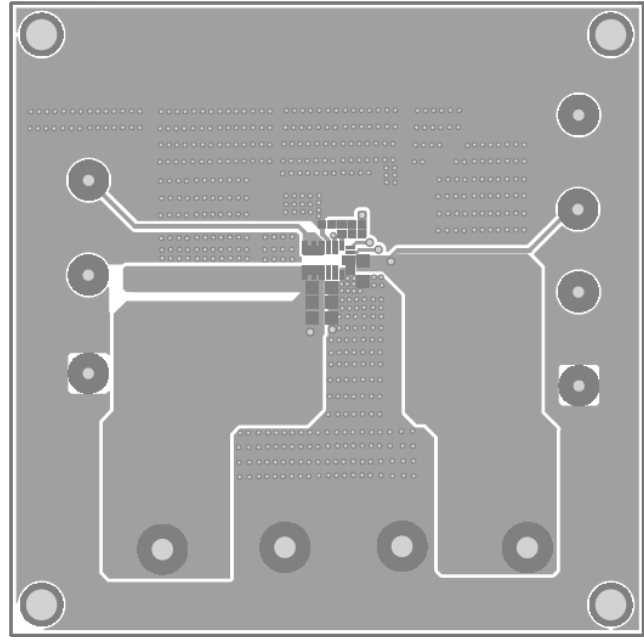

Figure 2—Top Layer

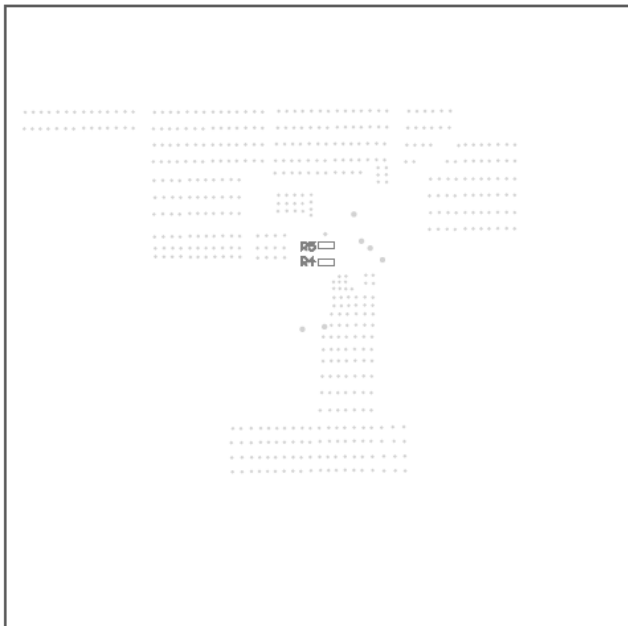

Figure 3—Bottom Silk Layer

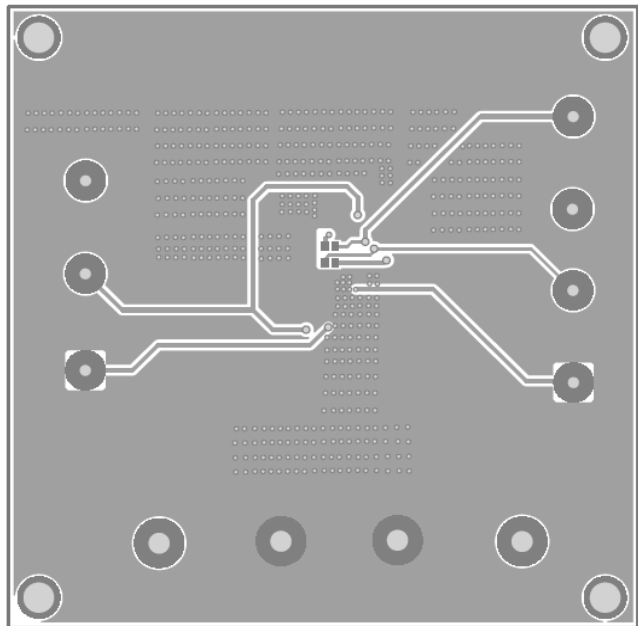

Figure 4—Bottom Layer

QUICK START GUIDE

1. Connect the positive and negative terminals of the load to the VOUT and GND pins, respectively.
2. Preset the power supply output between 5V and 18V, and then turn off the power supply.
3. Connect the positive and negative terminals of the power supply output to the VIN and GND pins, respectively.
4. Turn the power supply on. The board will automatically start up.
5. To use the Enable function, apply a digital input to the EN pin. Drive EN higher than 1.4V to turn on the converter, or less than 1.25V to turn it off.

NOTICE: The information in this document is subject to change without notice. Please contact MPS for current specifications. Users should warrant and guarantee that third party Intellectual Property rights are not infringed upon when integrating MPS products into any application. MPS will not assume any legal responsibility for any said applications.