

### DESCRIPTION

The EVM3620A-QV-00A is an evaluation board for MPM3620A, a synchronous rectified, step-down module converter with built-in power MOSFETs, inductor and two capacitors.

The evaluation board can deliver a 2A continuous output current with excellent load and line regulation over a wide input supply range.

Current-mode operation provides fast transient response and eases loop stabilization.

Full protection features include over-current protection and thermal shut down.

The MPM3620A is available in a space-saving QFN20 (3mm x5mmx1.6mm) package.

### ELECTRICAL SPECIFICATION<sup>(1)</sup>

Parameter	Symbol	Value	Units
Input Voltage	$V_{IN}$	12	V
Output Voltage	$V_{OUT}$	3.3	V
Output Current	$I_{OUT}$	2	A

**Notes:**

1) For different input, output spec, please refer to APPLICATION and TYPICAL APPLICATION CIRCUITS section on datasheet to choose proper values.

### FEATURES

- 2A Continuous Load Current
- 90mΩ/40mΩ Low  $R_{DS(ON)}$  Internal Power MOSFETs
- Integrated Inductor
- Integrated VCC and Bootstrap Capacitors
- Power Save Mode at Light Load
- Power Good Indicator
- OCP Protection and Hiccup
- Thermal Shutdown
- Output Adjustable from 0.8V
- Available in QFN20 (3x5x1.6mm) Package
- Total solution size 6.7mm x7.3mm

### APPLICATIONS

- Industrial Controls
- Medical and Imaging Equipment
- Telecom and Networking Applications
- LDO Replacement
- Space and Resource-limited Applications

All MPS parts are lead-free and adhere to the RoHS directive. For MPS green status, please visit MPS website under Products, Quality Assurance page.

"MPS" and "The Future of Analog IC Technology" are registered trademarks of Monolithic Power Systems, Inc.

## EVM3620A-QV-00A EVALUATION BOARD

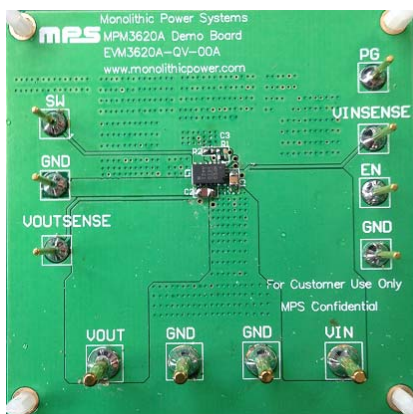

(L x W x H) 6.35cm x 6.35cm x 0.32cm

Board Number	MPS IC Number
EVM3620A-QV-00A	MPM3620AGQV

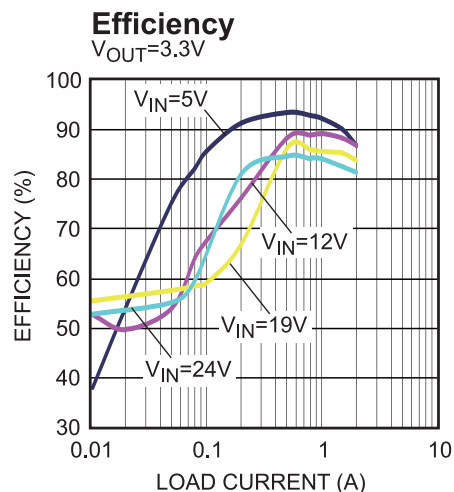

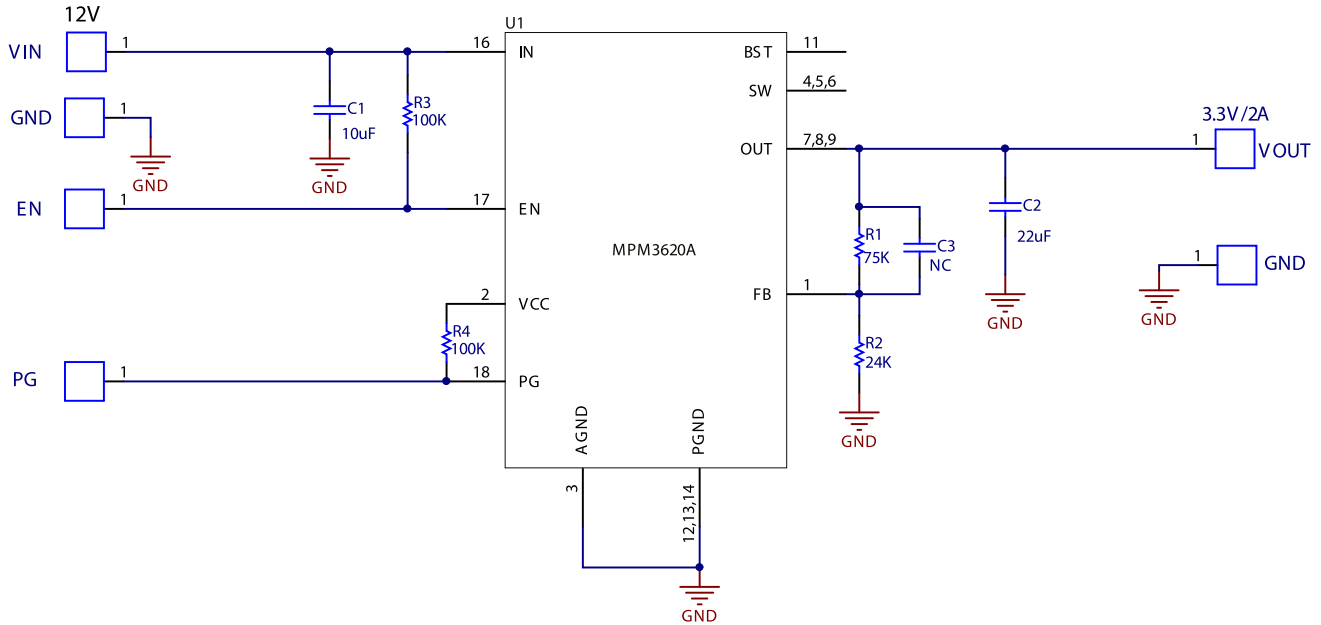
**EVALUATION BOARD SCHEMATIC**

**EVM3620A-QV-00A BILL OF MATERIALS**

Qty	Ref	Value	Description	Package	Manufacturer	Manufacturer P/N
1	C1	10µF	Ceramic Cap,25V,X5R	0805	muRata	GRM21BR61E106KA73L
1	C2	22µF	Ceramic Cap,16V,X5R	0805	muRata	GRM219R61C226ME15L
0	C3	NS				
1	R1	75k	Thick Film Res., 1%	0402	Any	
1	R2	24k	Thick Film Res., 1%	0402	Any	
1	R3	100k	Thick Film Res., 1%	0402	Any	
1	R4	100k	Thick Film Res., 1%	0402	Any	
1	U1	MPM3620A	Synchronous Step-Down Module Converter	QFN-20	MPS	MPM3620AGQV

## EVB TEST RESULTS

Performance waveforms are tested on the evaluation board.

$V_{IN} = 12V$ ,  $V_{OUT} = 3.3V$ ,  $T_A = 25^\circ C$ , unless otherwise noted.

### Output Ripple

Bandwidth=20MHz

$I_{OUT} = 2A$

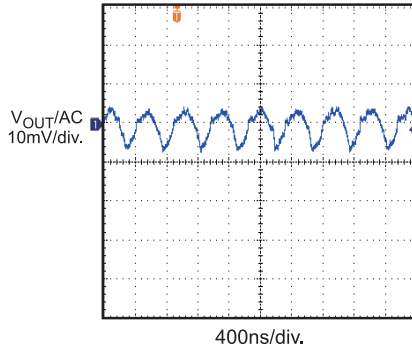

### Output Ripple

Bandwidth=150MHz

$I_{OUT} = 2A$

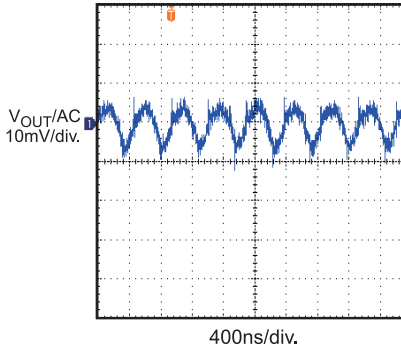

### Input/Output Ripple

$I_{OUT} = 0A$

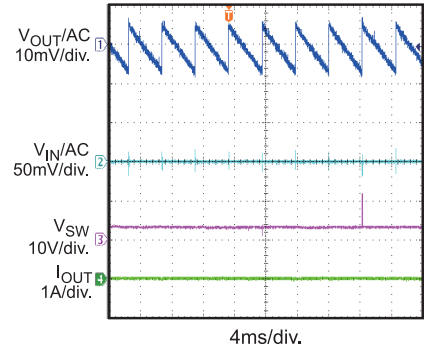

### Input/Output Ripple

$I_{OUT} = 2A$

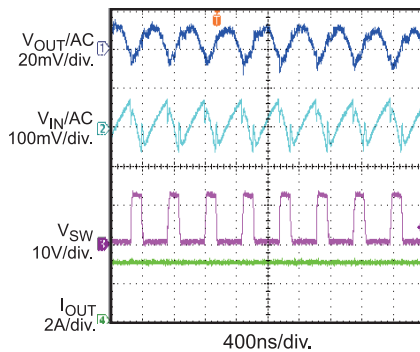

### Startup through Input Voltage

$I_{OUT} = 0A$

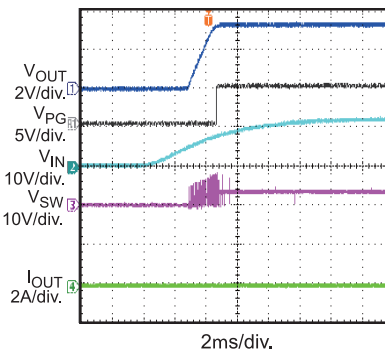

### Startup through Input Voltage

$I_{OUT} = 2A$

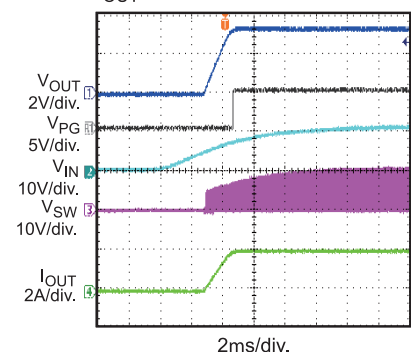

### Shutdown through Input Voltage

$I_{OUT} = 0A$

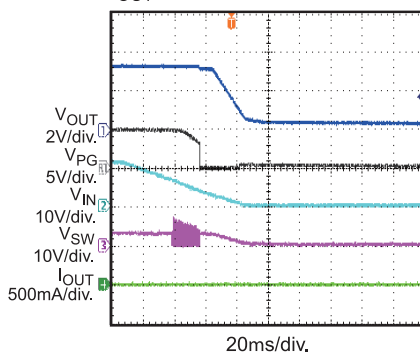

### Shutdown through Input Voltage

$I_{OUT} = 2A$

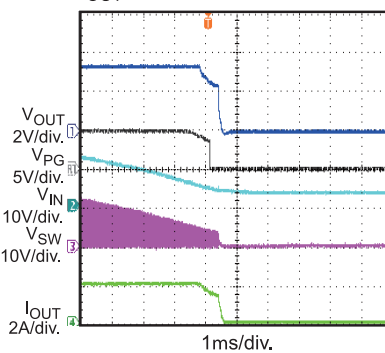

### Startup through Enable

$I_{OUT} = 0A$

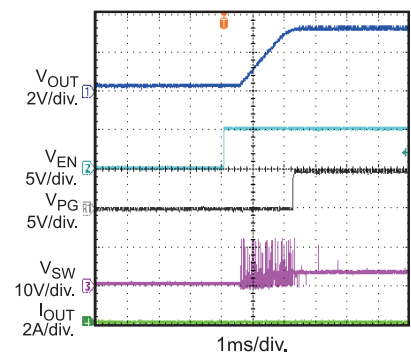

## EVB TEST RESULTS *(continued)*

Performance waveforms are tested on the evaluation board.

$V_{IN} = 12V$ ,  $V_{OUT} = 3.3V$ ,  $T_A = 25^\circ C$ , unless otherwise noted.

**Startup through Enable**  
 $I_{OUT} = 2A$

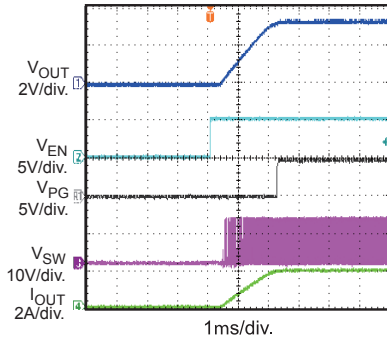

**Shutdown through Enable**  
 $I_{OUT} = 0A$

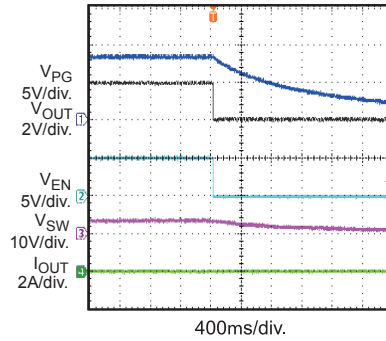

**Shutdown through Enable**  
 $I_{OUT} = 2A$

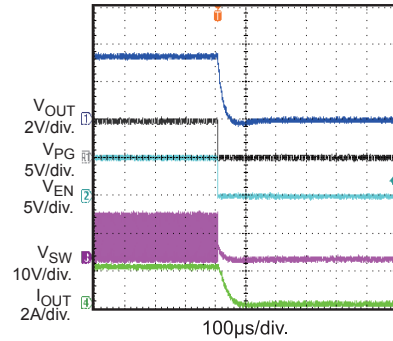

**Short Circuit Steady State**

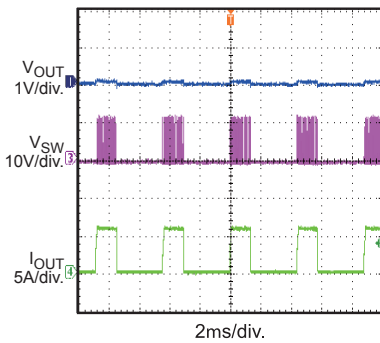

**Short Circuit Entry**  
 $I_{OUT} = 0A$

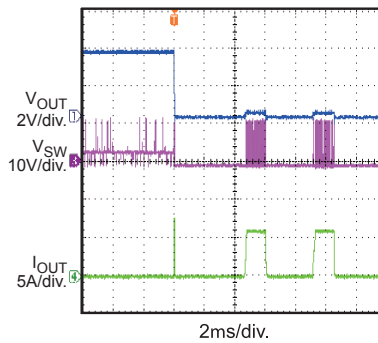

**Short Circuit Recovery**  
 $I_{OUT} = 0A$

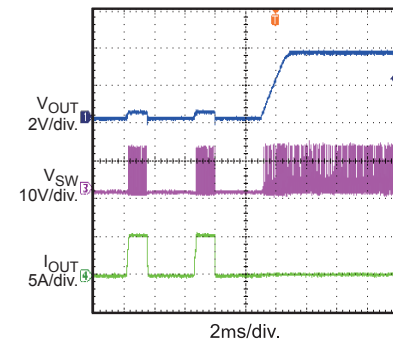

**Load Transient Response**  
1A to 2A

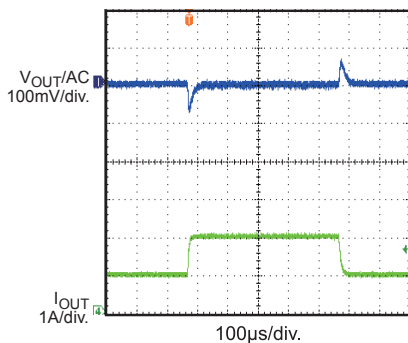

**PRINTED CIRCUIT BOARD LAYOUT**

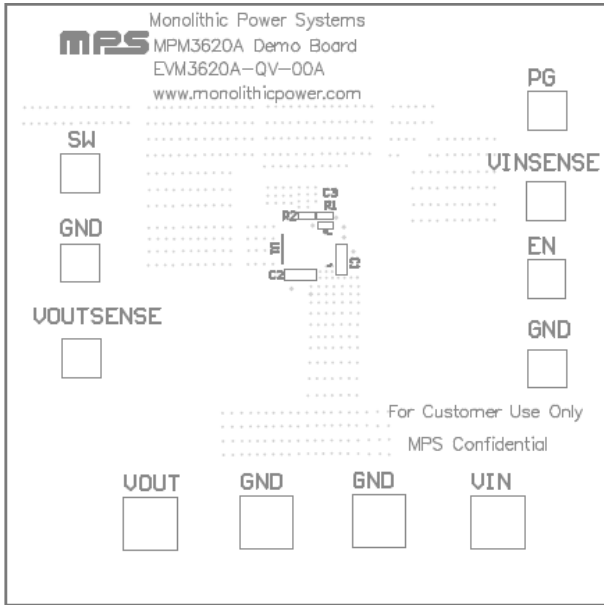

**Figure 1—Top Silk Layer**

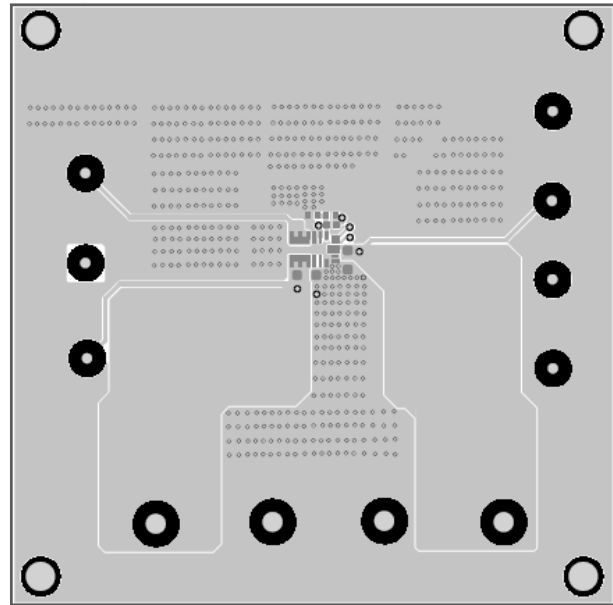

**Figure 2—Top Layer**

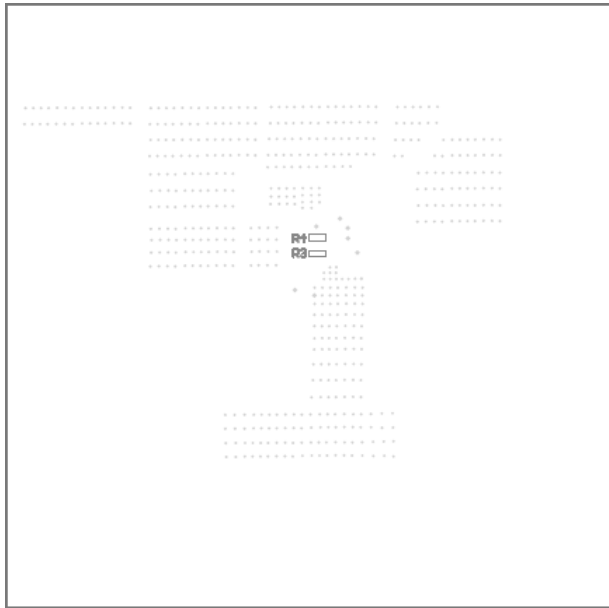

**Figure 3—Bottom Silk Layer**

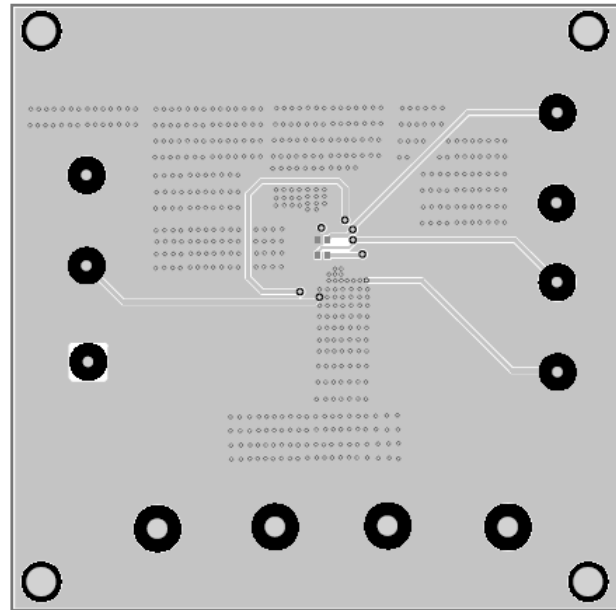

**Figure 4—Bottom Layer**

## QUICK START GUIDE

1. Connect the positive and negative terminals of the load to the  $V_{OUT}$  and GND pins, respectively.
2. Preset the power supply output between 4.5V and 24V, and then turn off the power supply.
3. Connect the positive and negative terminals of the power supply output to the  $V_{IN}$  and GND pins, respectively.
4. Turn the power supply on. The board will automatically start up.
5. To use the Enable function, apply a digital input to the EN pin. Drive EN higher than 1.4V to turn on the converter, or less than 1.25V to turn it off.

**NOTICE:** The information in this document is subject to change without notice. Please contact MPS for current specifications. Users should warrant and guarantee that third party Intellectual Property rights are not infringed upon when integrating MPS products into any application. MPS will not assume any legal responsibility for any said applications.