



# EVHF500-7-S-00A

85V<sub>AC</sub>~265V<sub>AC</sub>/50Hz, 12V/0.3A, 5V/0.3A  
Evaluation Board

## DESCRIPTION

The HF500-7 is a fixed-frequency, current-mode regulator with built-in slope compensation. The HF500-7 combines a 700V MOSFET of high-avalanche ruggedness and a full-featured controller into one chip to create a low-power, offline, flyback, switch-mode power supply.

The EVHF500-7-S-00A evaluation board is designed to demonstrate the capabilities of MPS's fixed switching frequency, multi-mode flyback regulator. It is designed for general-purpose offline power supplies.

The EVHF500-7-S-00A can meet EN55022 Class B conducted EMI requirements. It has multiple protection functions, including brown in/out, overload protection (OLP), over-voltage protection (OVP), short-circuit protection (SCP), cycle-by-cycle current limiting, and over-temperature protection (OTP).

The EVHF500-7-S-00A specification is listed in the table below.

## ELECTRICAL SPECIFICATION

Parameter	Symbol	Value	Units
Input voltage	V <sub>IN</sub>	90 to 265	V <sub>AC</sub>
Output voltage1	V <sub>OUT1</sub>	12	V
Output current1	I <sub>OUT1</sub>	0.3	A
Output voltage2	V <sub>OUT2</sub>	5	V
Output current2	I <sub>OUT2</sub>	0.3	A
Output power	P <sub>OUT</sub>	5.1	W

## FEATURES

- 700V/12Ω Integrated MOSFET with High Single-Pulse Avalanche Energy
- Fixed-Frequency, Current-Mode Control Operation with Built-In Slope Compensation
- Frequency Foldback Down to f<sub>OSC(min)</sub> at Light Load
- Burst Mode for Low Standby Power Consumption
- Frequency Jittering for Reduced EMI Signature
- Over-Power Compensation
- Internal High-Voltage Current Source
- VCC Under-Voltage Lockout (UVLO) with Hysteresis
- Programmable Input B/O and Over-Voltage Protection (OVP)
- Overload Protection (OLP) with Programmable Delay
- Latch-Off Protection on TIMER
- Thermal Shutdown (Auto-Restart with Hysteresis)
- Short-Circuit Protection (SCP)
- Programmable Soft Start (SS)

**EVHF500-7-S-00A EVALUATION BOARD**

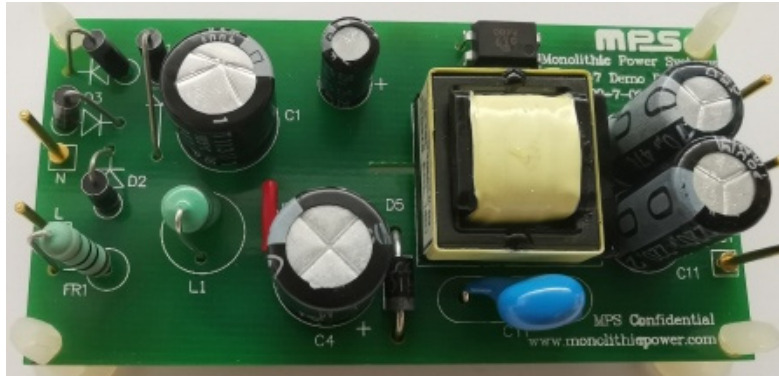

**TOP VIEW**

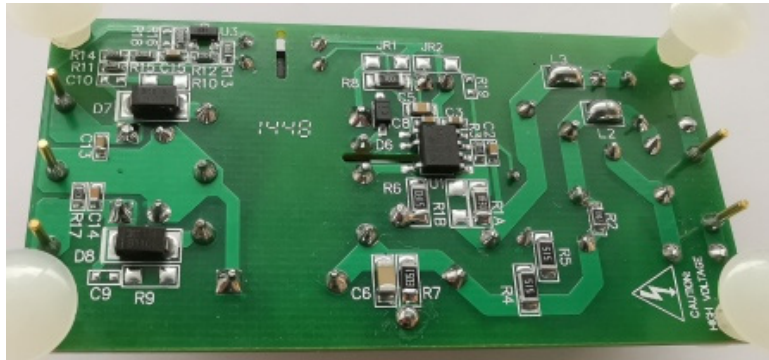

**BOTTOM VIEW**

(L x W x H) 7.0cm x 3.5cm x 2.4cm

Board Number	MPS IC Number
EVHF500-7-S-00A	HF500-7GS

## EVALUATION BOARD SCHEMATIC

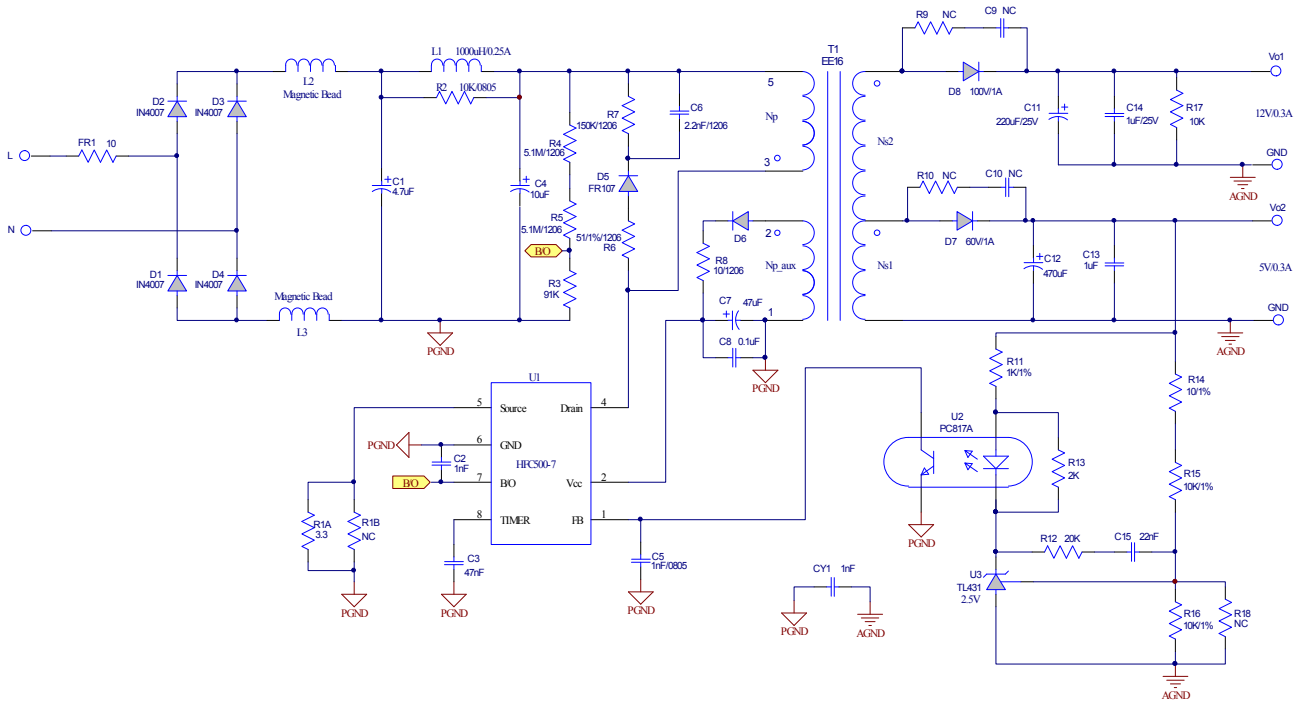
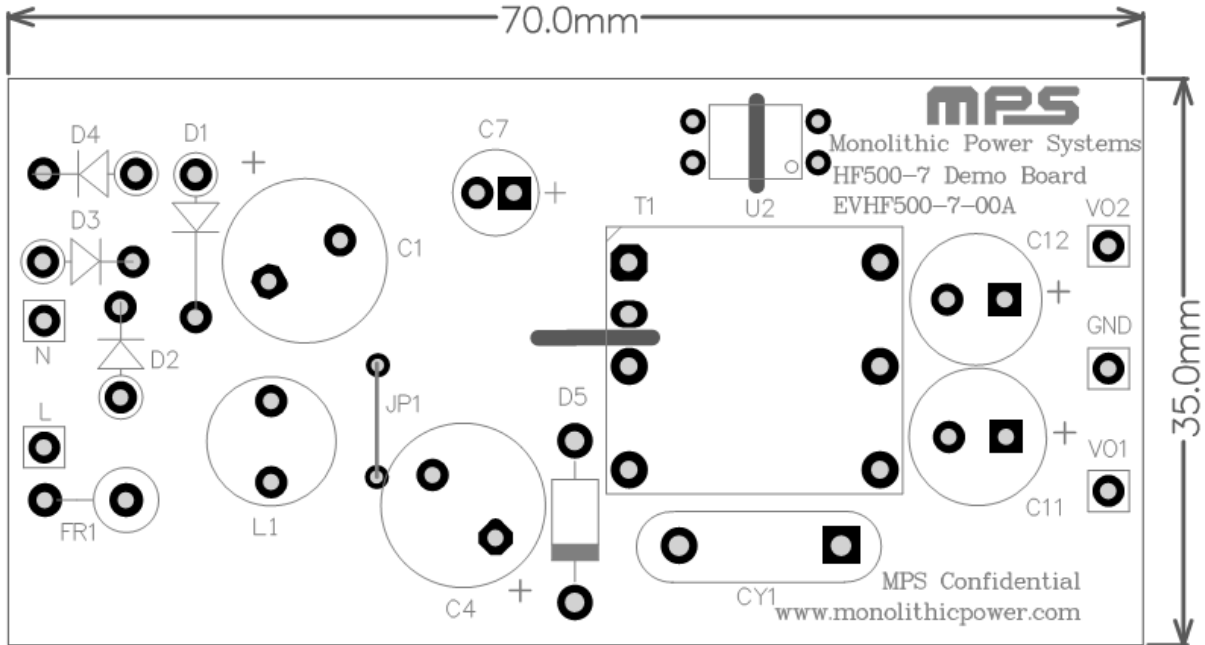
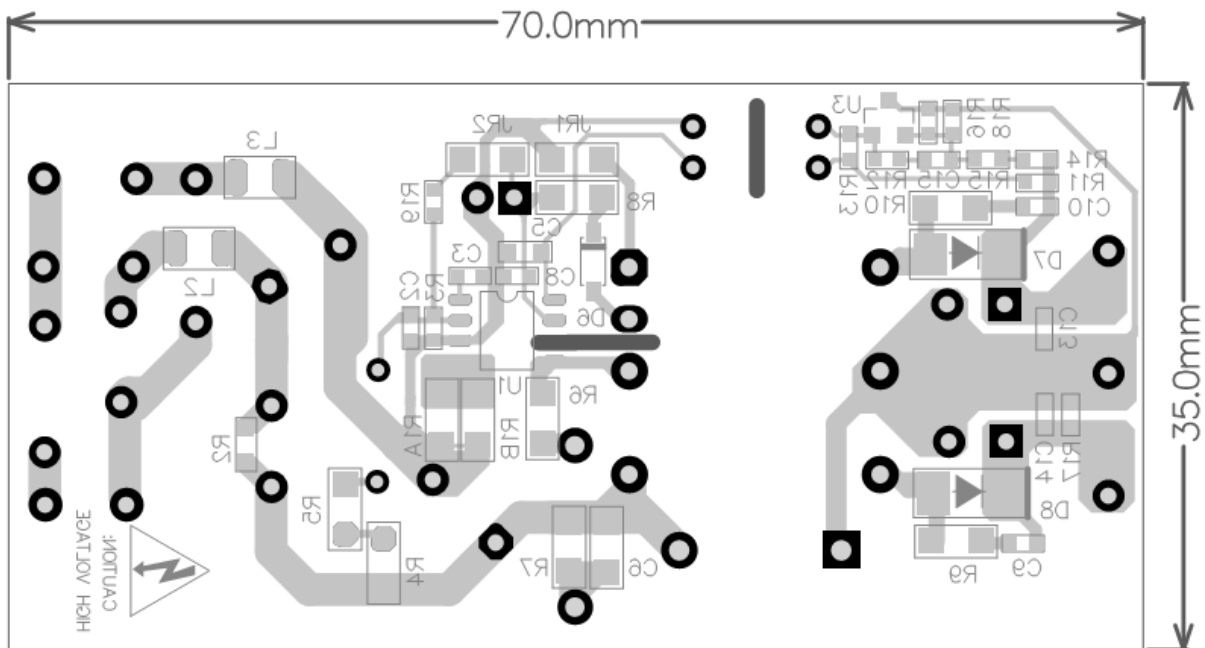

Figure 1: Schematic

**PCB LAYOUT (SINGLE-SIDED)**



**Figure 2: Top Layer**



**Figure 3: Bottom Layer**

**EVHF500-7-S-00A BILL OF MATERIALS**

Qty	RefDes	Value	Description	Package	Manufacturer	Manufacturer_P/N
1	C1	4.7µF	Capacitor;400V;20%	DIP	Rubycon	400WXA4.7MEFC
1	C2	1nF	Ceramic Capacitor;50V;X7R;	0603	muRata	GRM188R71H102KA01D
1	C3	47nF	Ceramic Capacitor;50V;X7R;	0603	muRata	GRM188R71H473KA61D
1	C4	10µF	Electrolytic Capacitor;400V;	DIP	Ltec	TY Series
1	C5	1nF	Ceramic Capacitor;50V;X7R;	0805	muRata	GRM216R71H102KA01
1	C6	2.2nF	Ceramic Capacitor;630V;X7R;	1206	Murata	GRM31BR72J222KW01L
1	C7	47µF	Electrolytic Capacitor;25V;	DIP	Jianghai	CD28L-25V47
1	C8	0.1µF	Ceramic Capacitor;25V;X7R;	0603	Yageo	CC0603KRX7R8BB104
0	C9, C10	NC				
1	C11	220µF	Electrolytic Capacitor;25V;	DIP	Jianghai	CD287-25V220
1	C12	470µF	Electrolytic Capacitor;10V;	DIP	Jianghai	CD287-10V470
1	C13	1µF	Ceramic Capacitor;10V;X7R	0603	Murata	GRM188R71A105KA61D
1	C14	1µF	Ceramic Capacitor;25V;X7R;	0603	muRata	GRM188R71E105KA12D
1	C15	22nF	Ceramic Capacitor;50V;X7R;	0603	muRata	GRM188R71H223KA01D
1	CY1	1nF	Y Capacitor;4000V;20%	DIP	Hongke	JNK09E102MY02N
4	D1,D2, D3,D4	1N4007	Diode;1000V;1A	DO-41	Diodes	1N4007
1	D5	FR107	Diode;1000V;1A	DO-41	Diodes	FR107
1	D6	BAV21 W	Diode;200V;0.2A;	SOD-123	Diodes	BAV21W-7-F
1	D7	B160	Schottky Diode;60V;1A;	SMA	Diodes	B160
1	D8	B1100	Schottky Diode;100V;1A;	SMA	Diodes	B1100-13-F
1	FR1	10	Resistor;5%;1W	DIP	Yageo	FKN1WSJT-52-10R
1	L1	1000µH	Color Inductor;1000uH;250mA	DIP	Any	1mH/250mA
2	L2, L3		Shorted			
1	R1A	3.3	Film Resistor;1%;1/4W;	1206	Royalolm	1206F330KT5E
0	R1B	NC				
1	R2	10K	Film Resistor;1%	0805	Yageo	RC0805FR-0710KL
1	R3	91K	Film Resistor;1%;	0603	Yageo	RC0603FR-0791KL
2	R4, R5	5.1M	Film Resistor;5%;	1206	Yageo	RI1206L515JT
1	R6	51	Resistor;1%	1206	Yageo	RC1206FR-0751RL
1	R7	150K	Resistor;1%	1206	Yageo	RC1206FR-07150KL
1	R8	10	Film Resistor;5%	1206	Yageo	RC1206JR-0710R
0	R9, R10	NC				
1	R11	1K	Film Resistor;1%	0603	Yageo	RC0603FR-071KL
1	R12	100K	Resistor;1%;1/10W;	0603	Yageo	RC0603FR-07100KL

**EVHF500-7-S-00A BILL OF MATERIALS (continued)**

Qty	RefDes	Value	Description	Package	Manufacturer	Manufacturer_P/N
1	R13	2K	Film Resistor;5%;1/10W	0603	LIZ	CR0603JA0202G
1	R14	10	Film Resistor;1%;	0603	Yageo	RC0603FR-0710RL
2	R15, R16	10K	Film Resistor;1%;	0603	Yageo	RC0603FR-0710KL
1	R17	10K	Resistor;5%;	0603	Royalohm	0603J0103T5E
0	R18	NC				
1	T1	FX0378	Transformer;3.5mH;	EE16		FX0378
1	U1	HF500-7	Multiple Mode Flyback Regulator	SOIC-8	MPS	
1	U3	TL431K	Voltage Reference	SOT-23		TL431K
5	GND, L, N, VO1, VO2		Connector;1.0mm 公针			
1	JP1		7mm 跳线			

## TRANSFORMER SPECIFICATION

### Electrical Diagram

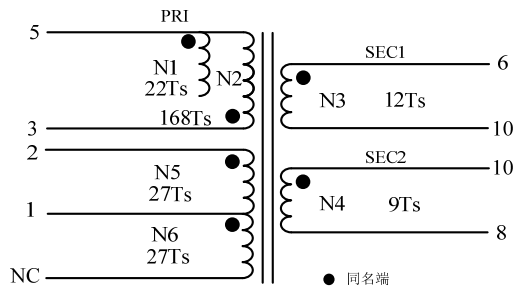

**Figure 4:Transformer Electrical Diagram**

- Note: 1. N4 is anti-clockwise, which is opposite with other windings  
 2. N5 and N6 is wound in parallel;  
 3. Cut Pin4, Pin7, Pin9;

### Winding Diagram

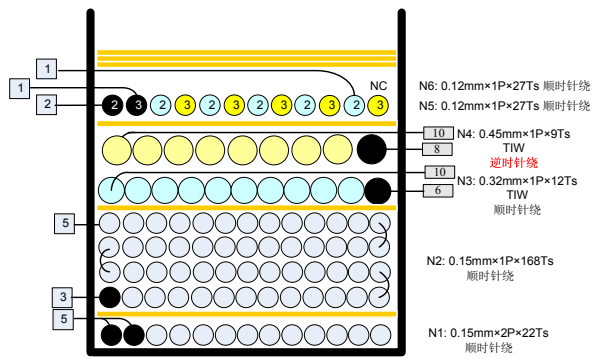

**Figure 5: Transformer Winding Diagram**

**Winding Order**

Tape 胶带圈数(T)	Sequence 绕组顺序	Start-End 始末脚位	Wire Dia 线径( $\varphi$ )	Turns 圈数( T )	Tube 套管
0	N1	5— $\rightarrow$ NC	0.15*2	22	None
1		Clockwise			
1	N2	3— $\rightarrow$ 5	0.15*1	168	None
1		Clockwise			
1	N3	6— $\rightarrow$ 10	0.32*1 TIW	12	None
1		Clockwise			
3	N4	8— $\rightarrow$ 10	0.45*1 TIW	9	None
		Anti-clockwise			
	N5, N6	2— $\rightarrow$ 1 1— $\rightarrow$ NC	0.12*1 0.12*1	27 27	None

**Electrical Specifications**

<b>Electrical Strength</b>	60 second, 60Hz, from PRI. to SEC.	3500VAC
	60 second, 60Hz, from PRI. to CORE.	500VAC
	60 second, 60Hz, from SEC. to CORE.	3500VAC
<b>Primary Inductance</b>	Pins 3 - 5, all other windings open, measured at 60kHz, 0.1 VRMS	3.5mH $\pm$ 10%
<b>Primary Leakage Inductance</b>	Pins 3 - 5 with all other pins shorted, measured at 60kHz, 0.1 VRMS	<100 $\mu$ H $\pm$ 10%

**Materials**

Item	Description
1	Core: EE16
2	Bobbin: EE16 Vertical, 5+5PIN 1 SECT TH, UL94V-0
3	Wire: $\Phi$ 0.12mm,, 2UEW, Class B
4	Wire: $\Phi$ 0.15mm,, 2UEW, Class B
5	Triple Insulation Wire: $\Phi$ 0.45mm TIW, $\Phi$ 0.32mm TIW
6	Tape: 8mm(W) $\times$ 0.06mm(TH)
7	Varnish: JOHN C. DOLPH CO, BC-346A or equivalent
8	Solder Bar: CHEN NAN: SN99.5/Cu0.5 or equivalent



## CIRCUIT DESCRIPTION

The EVHF500-7-S-00A is a single-stage flyback converter with a multi-mode flyback regulator. The input is universal and the dual outputs are 12V/0.3A and 5V/0.3A respectively. The HF500-7 combines a 700V MOSFET of high-avalanche ruggedness with a full-featured controller into one chip.

FR1, D1, D2, D3, D4, L1, L2, L3, C1, C4 and R2 compose the input stage. FR1 is the fusible resistor and is used to protect the component from failure or some excessive short events. C1, C4, and L1 are also configured for the differential mode EMI filter to suppress conducted EMI. D1, D2, D3 and D4 are configured for the rectifier bridge to convert AC voltage to DC voltage. L2 and L3 are magnetic beads to restrain high-frequency noise for a lower radiated EMI. R2 is the resistor paralleled with L1 to dampen the oscillation between C1, C2, and L1, which also helps improve EMI.

R6, R7, C6, and D5 are configured RCD snubbers to suppress voltage spikes of the MOSFET.

R8, C7, C8, and D6 are used as VCC power supplies.

R3, R4, R5, and C2 are configured as input brown in/out detection circuits. These functions can be disabled by connecting a ~100kΩ resistor between VCC and B/O, which can decrease no-load power consumption.

The HF500-7 and its peripheral components are configured as a flyback controller circuit. C3 is used to set the jittering period and the clock for protections such as OLP.

R1A and R1B are the current sensing resistors.

T1 is the transformer to transfer power from the primary side to the secondary side. T1 is a key component for the entire circuit to work normal with optimal performance. Therefore, T1 must be designed carefully.

CY1 is safety Y capacitor lowering common-mode noise to ensure a sufficient EMI margin.

D8 is the secondary rectifier for output channel 1 and the D7 is the secondary rectifier for output channel 2. R9/C9 and R10/C10 are the snubber of D8 and D7 respectively to suppress high-voltage spikes on the rectifier.

C11/C14 and C12/C13 are output capacitors to filter the output voltage ripple.

R12 and C15 are configured as the compensation network. R14, R15, R16, and R18 are feedback resistors.

U3 is the voltage reference and U2 is the optocoupler, which is used to transfer the signal from the secondary side to the primary side to regulate the output voltage. The optocoupler working current flows through R11 while the TL431 bias current flows through R13.

## EVb TEST RESULTS

### Performance Data

$T_A = 25^\circ\text{C}$ , unless otherwise noted.

### Efficiency

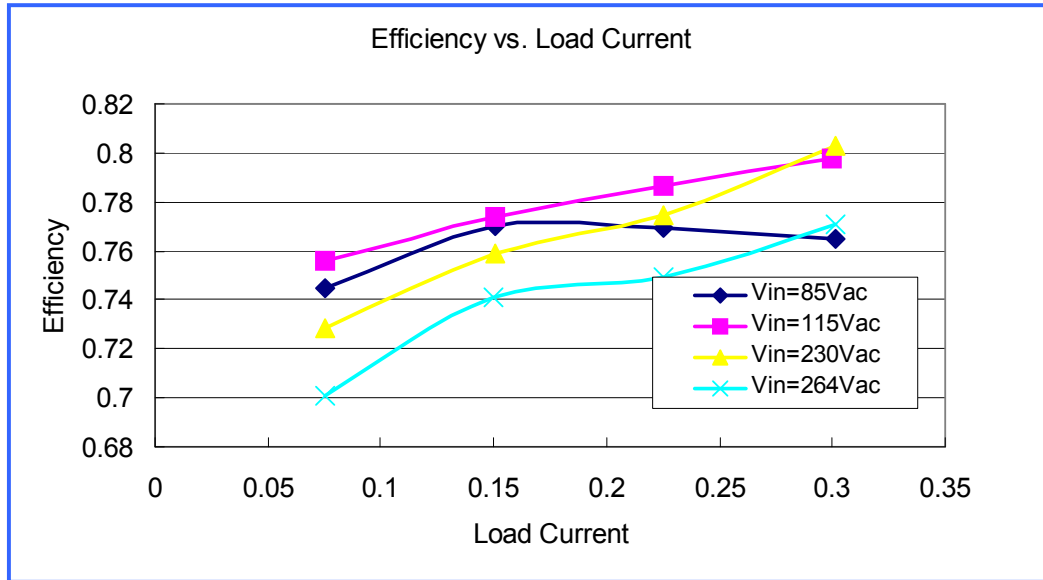

Note: The current is for 2 channels.

### No Load Consumption

Test Condition	~10M Voltage divider connects with B/O	Pull up B/O by 10kΩ resistor
Vin (VAC)	Pin (mW)	Pin (mW)
85	131.2	140.7
110	97.9	121.3
220	101.8	120.7
265	103.6	126.1

**Conducted EMI Test**

Test with 115V<sub>AC</sub>/230V<sub>AC</sub> input and full load condition

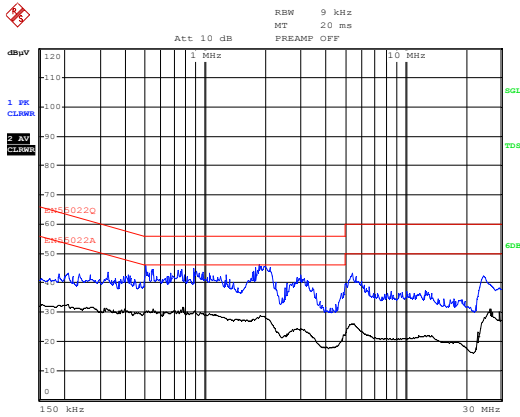

Date: 1.SEP.2014 15:41:28

L Line

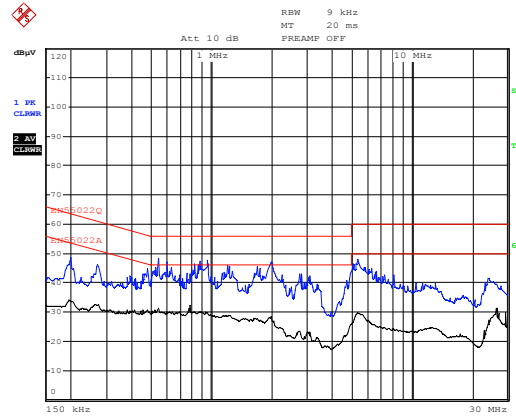

Date: 1.SEP.2014 15:35:17

N Line

**115Vac, 60Hz, Maximum Load, L & N Line, Output GND Floats, EN55022 Class B Limits**

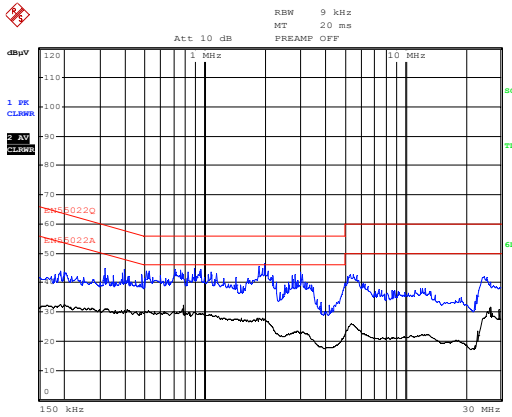

Date: 1.SEP.2014 15:38:22

L Line

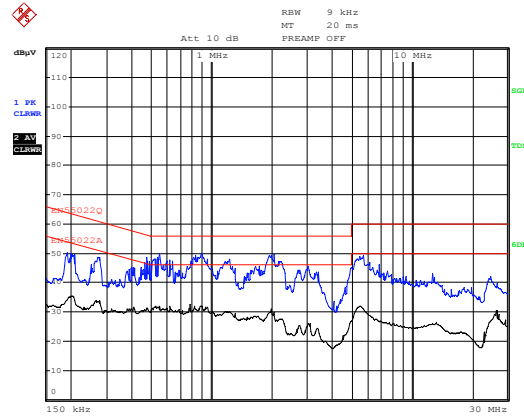

Date: 1.SEP.2014 15:32:09

N Line

**230Vac, 50Hz, Maximum Load, L Line, Output GND Floats, EN55022 Class B Limits**

**Thermal Test**

Test with 85V<sub>AC</sub>/265V<sub>AC</sub> input and full load condition. PCB layout with 10oz copper. T<sub>A</sub> = 27°C.

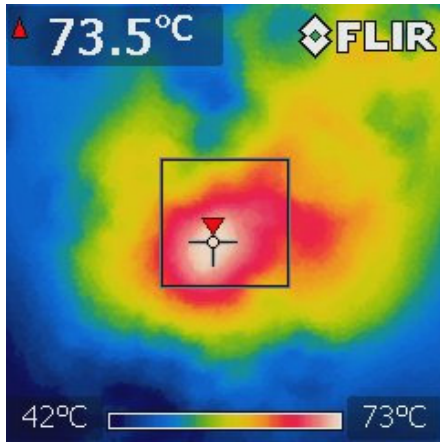

TOP

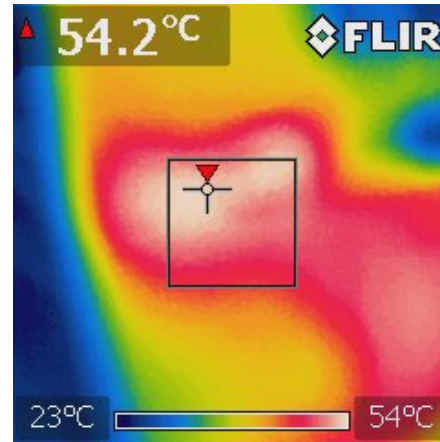

BOTTOM

Vin=85Vac, Thermal Performance

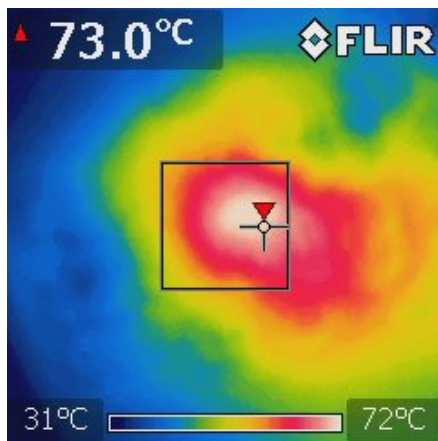

TOP

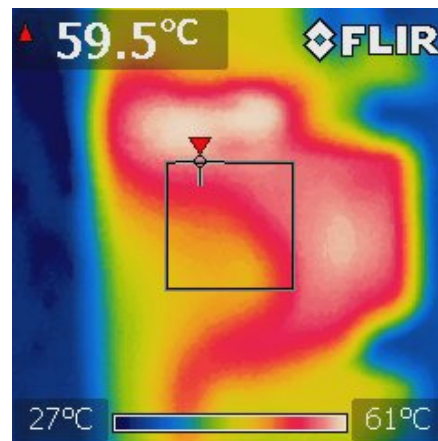

BOTTOM

Vin=265Vac, Thermal Performance

**Quick Start Guide**

1. Preset the power supply to  $85V_{AC} \leq V_{IN} \leq 265V_{AC}$ .
2. Turn the power supply off.
3. Connect the line and neutral terminals of the power supply output to the L and N ports. For three-wire input applications, connect the OUTPUT GND connected to Earth.
4. Connect the load to:
  - a. Positive (+): VO1, VO2
  - b. Negative (-): GND
5. Turn the power supply on after making the connections.

**NOTICE:** The information in this document is subject to change without notice. Please contact MPS for current specifications. Users should warrant and guarantee that third party Intellectual Property rights are not infringed upon when integrating MPS products into any application. MPS will not assume any legal responsibility for any said applications.