



# EVBL4423H-Q-00A

3A, 36V, Synchronous Step-Down Converter Evaluation Board

## DESCRIPTION

The EVBL4423H-Q-00A is an evaluation board for the MPQ4423H/MPQ4423H-AEC1 with MPS power inductor stuffed. MPQ4423H/MPQ4423H-AEC1 is a high-frequency, synchronous, rectified, step-down, switch-mode converter with built-in power MOSFETs. It offers a very compact solution to achieve a 3A continuous output current with excellent load and line regulation over a wide input supply range. The MPQ4423H/MPQ4423H-AEC1 has synchronous mode operation for higher efficiency over the output current load range.

Current-mode operation provides fast transient response and eases loop stabilization.

Full protection features include over-current protection and thermal shut down.

The EVBL4423H-Q-00A is assembled and tested with QFN-8 (3mmx3mm) package.

## ELECTRICAL SPECIFICATIONS

Parameter	Symbol	Value	Units
Input Voltage	V <sub>IN</sub>	4-36	V
Output Voltage	V <sub>OUT</sub>	3.3	V
Output Current	I <sub>OUT</sub>	3	A

## FEATURES

- Wide 4V to 36V Continuous Operating Input Range
- 85mΩ/55mΩ Low RDS(ON) Internal Power MOSFETs
- High-Efficiency Synchronous Mode Operation
- Default 410kHz Switching Frequency
- Synchronizes to a 200kHz to 2.2MHz External Clock
- High Duty Cycle for Automotive Cold-crank
- Power-Save Mode
- Internal Soft-Start
- Power Good
- Over-Current Protection (OCP) and Hiccup
- Thermal Shutdown
- Available in AEC-Q100 Grade 1
- Fully Assembled and Tested
- MPS Power Inductor Stuffed

## APPLICATIONS

- Automotive
- Industrial Control System
- Distributed Power Systems

All MPS parts are lead-free and adhere to the RoHS directive. For MPS green status, please visit MPS website under Quality Assurance. "MPS" and "The Future of Analog IC Technology" are Registered Trademarks of Monolithic Power Systems, Inc.

## EVBL4423H-Q-00A EVALUATION BOARD



(L x W x H) 2.5" x 2.5" x 0.2"  
(6.35cm x 6.35cm x 0.5cm)

Board Number	MPS IC Number
EVBL4423H-Q-00A	MPQ4423HGQ

Efficiency vs. Load Current  
V<sub>OUT</sub> = 3.3V

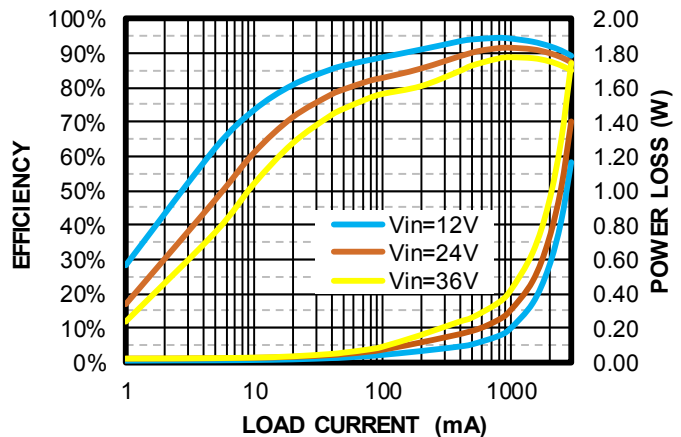

## EVALUATION BOARD SCHEMATIC

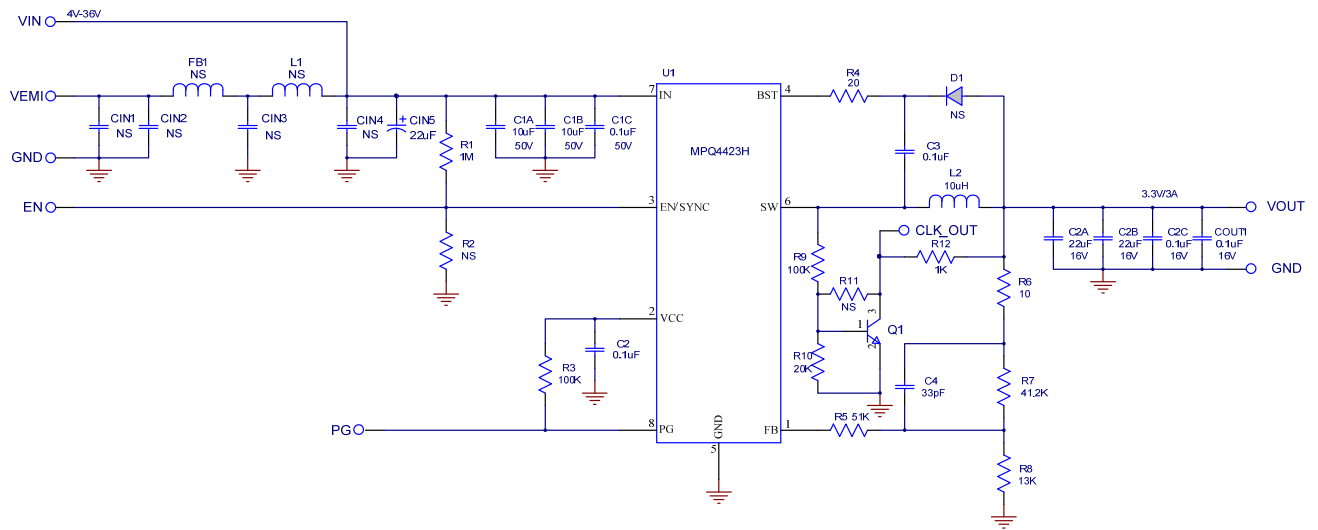

**EVBL4423H-Q-00A BILL OF MATERIALS**

Qty	RefDes	Value	Description	Package	Manufacturer	Manufacturer_P/N
2	C1A,C1B	10µF	Ceramic Cap., 50V, X7R	1210	muRata	GRM32ER71H106KA12L
1	C1C	0.1µF	Ceramic Cap., 50V, X7R	0603	muRata	GRM188R71H104KA93D
2	C2A,C2B	22µF	Ceramic Cap., 16V, X7R	1210	muRata	GRM32ER71C226KE79
4	C2,C2C,C3, COUT1	0.1µF	Ceramic Cap., 16V, X7R	0603	muRata	GRM188R71C104KA01D
1	C4	33pF	Ceramic Cap., 50V, C0G	0603	muRata	GRM1885C1H330JA01D
4	CIN1-CIN4	NS				
1	CIN5	22µF	Electrolytic Cap.	SMD	Jianghai	VTD-63V22
1	D1	NS				
1	FB1	NS				
1	L1	NS				
1	L2	10µH	Inductor, 27mΩ DCR, 7A	SMD	MPS	MPL-AL6060-100
1	R1	1M	Film Res., 5%	0603	Yageo	RC0603JR-071ML
2	R3,R9	100K	Film Res., 1%	0603	Yageo	RC0603FR-07100KL
1	R4	20	Film Res., 1%	0603	Yageo	RC0603FR-0720RL
1	R5	51K	Film Res., 1%	0603	Yageo	RC0603FR-0751KL
1	R6	10	Film Res., 1%	0603	Yageo	RC0603FR-0710RL
1	R7	41.2K	Film Res., 1%	0603	Yageo	RC0603FR-0741K2L
1	R8	13K	Film Res., 1%	0603	Yageo	RC0603FR-0713KL
1	R10	20K	Film Res., 1%	0603	Yageo	RC0603FR-0720KL
1	R12	1K	Film Res., 1%	0603	Yageo	RC0603FR-071KL
2	R2,R11	NS				
1	Q1		Transistor, 40V, 0.2A	SOT-23	ON Semiconductor	MMBT3904LT1
1	U1		Step-Down Regulator	QFN3X3-8	MPS	MPQ4423HGQ
5	VIN, VEMI, GND, VOUT, GND		2.0 Golden Pin		HZ	
5	EN/SYNC, GND, PG, GND, CLK, OUT		1.0 Golden Pin		HZ	

**EVB TEST RESULTS**

$V_{IN} = 12V$ ,  $V_{OUT} = 3.3V$ ,  $C_{OUT} = 2x22\mu F$ ,  $L = 10\mu H$ ,  $T_A = +25^\circ C$ , unless otherwise noted.

**Efficiency vs. Load Current**  
 $V_{OUT} = 3.3V$

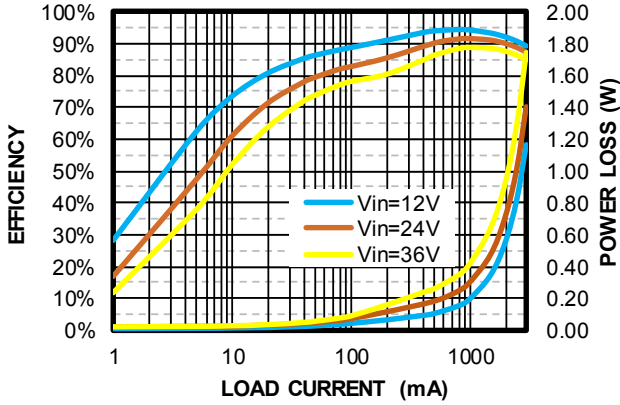

**Efficiency vs. Load Current**  
 $V_{OUT} = 5V$

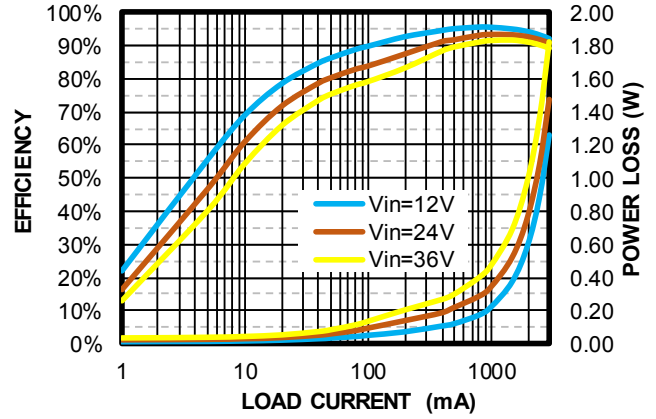

**EVB TEST RESULTS (continued)**

$V_{IN} = 12V$ ,  $V_{OUT} = 3.3V$ ,  $C_{OUT} = 2 \times 22\mu F$ ,  $L = 10\mu H$ ,  $T_A = +25^\circ C$ , unless otherwise noted.

**Steady State**

$I_{OUT} = 0A$

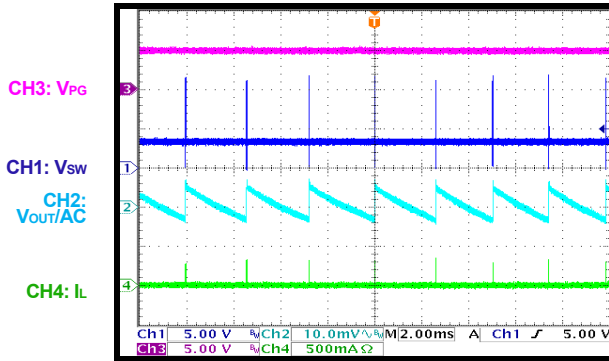

**Steady State**

$I_{OUT} = 3A$

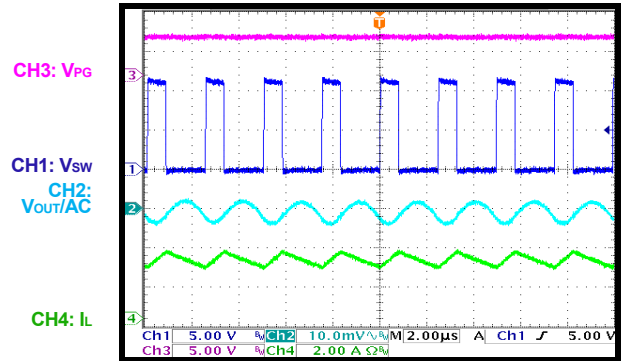

**Power On**

$I_{OUT} = 0A$

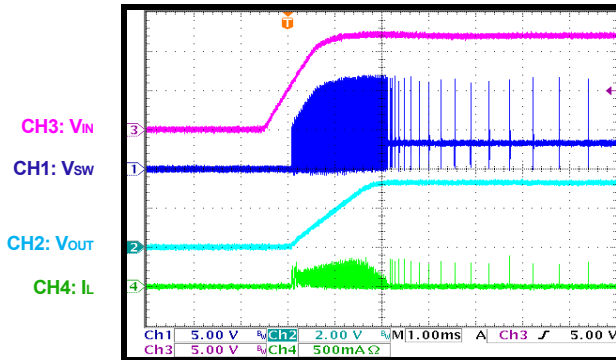

**Power On**

$I_{OUT} = 3A$

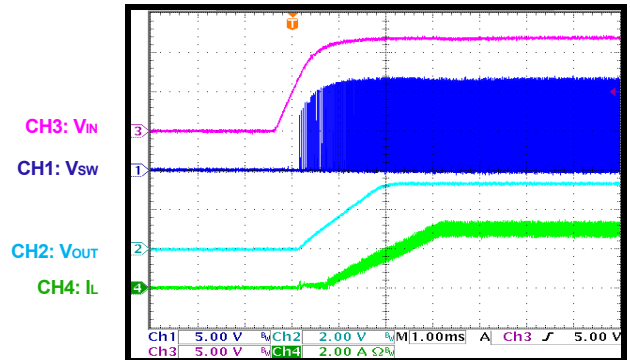

**Power Off**

$I_{OUT} = 0A$

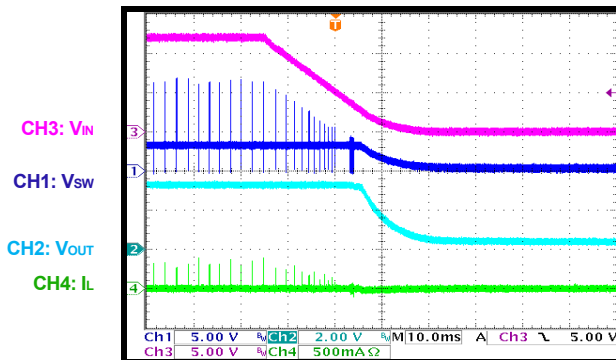

**Power Off**

$I_{OUT} = 3A$

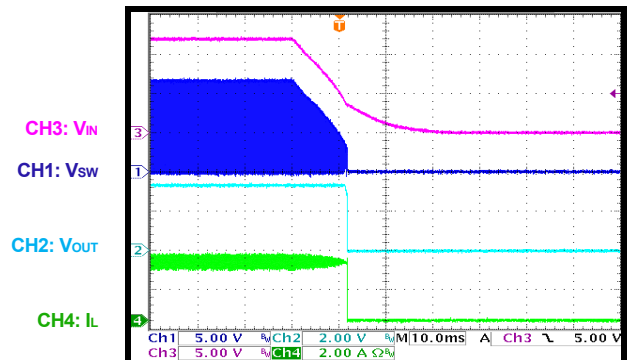

**EVB TEST RESULTS (continued)**

$V_{IN} = 12V$ ,  $V_{OUT} = 3.3V$ ,  $C_{OUT} = 2 \times 22\mu F$ ,  $L = 10\mu H$ ,  $T_A = +25^\circ C$ , unless otherwise noted.

**En On**  
 $I_{OUT} = 0A$

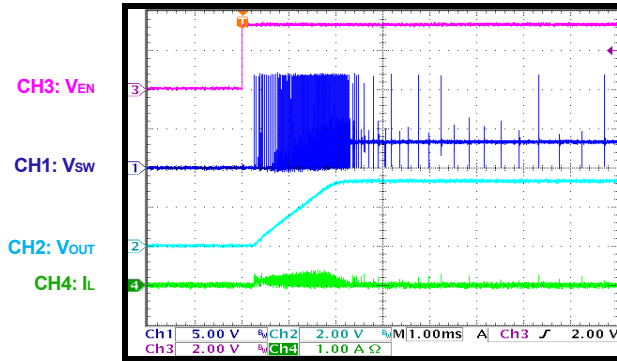

**En On**  
 $I_{OUT} = 3A$

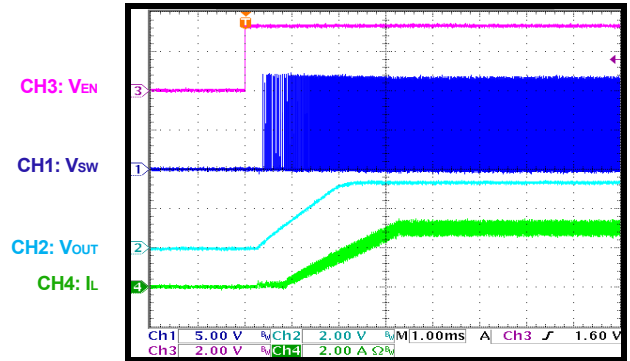

**En Off**  
 $I_{OUT} = 0A$

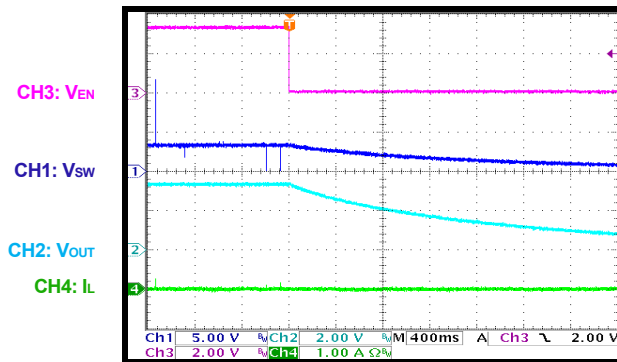

**En Off**  
 $I_{OUT} = 3A$

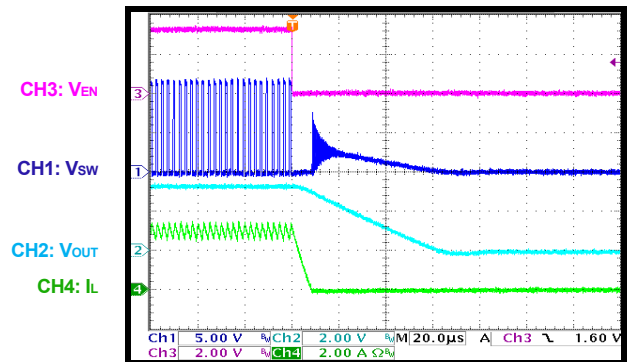

**SCP Entry**  
 $I_{OUT} = 0A$

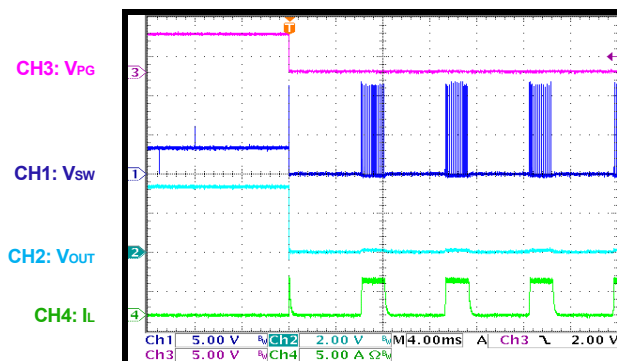

**SCP Entry**  
 $I_{OUT} = 3A$

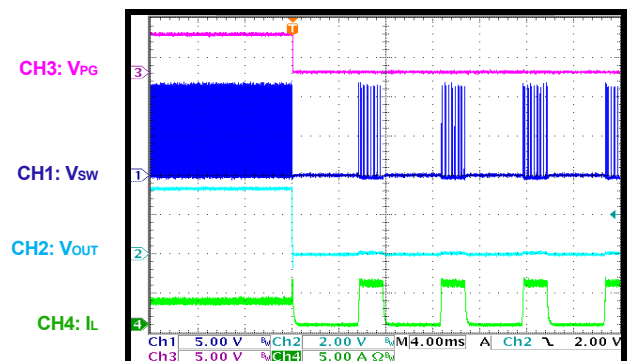

**EVB TEST RESULTS (continued)**

$V_{IN} = 12V$ ,  $V_{OUT} = 3.3V$ ,  $C_{OUT} = 2 \times 22\mu F$ ,  $L = 10\mu H$ ,  $T_A = +25^\circ C$ , unless otherwise noted.

**SCP Steady State**

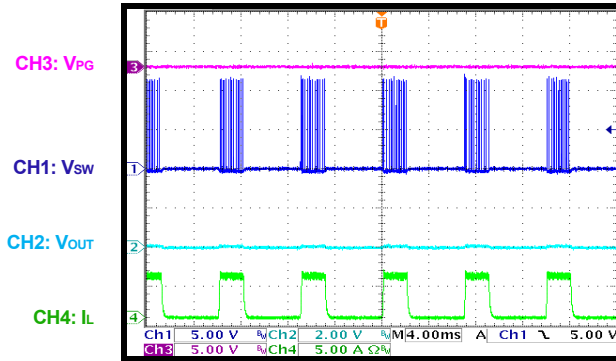

**SCP Recovery**

$I_{OUT} = 0A$

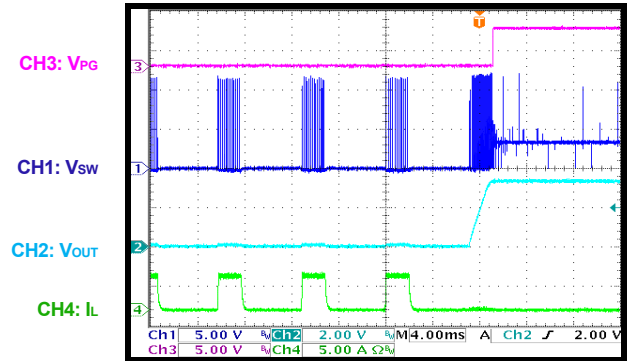

**SCP Recovery**

$I_{OUT} = 3A$

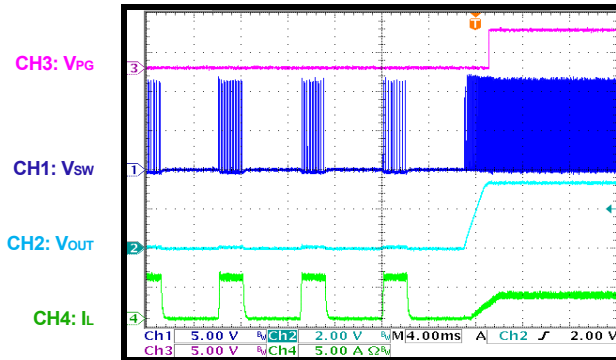

**Load Transient**

$I_{OUT} = 1.5A - 3A$

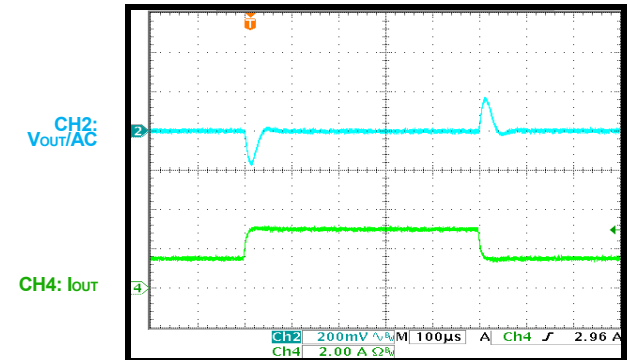

**Cold Crank**

$V_{IN} = 12V \rightarrow 4V \rightarrow 5V$ ,  $I_{OUT} = 0A$

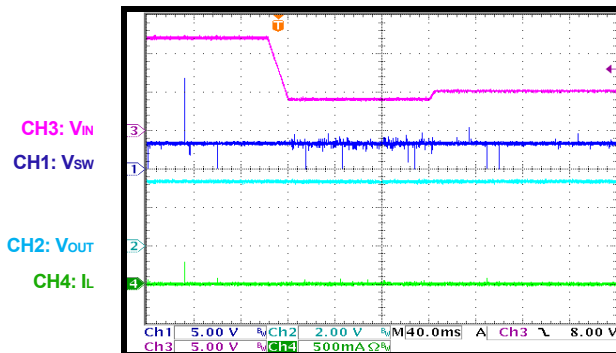

**Cold Crank**

$V_{IN} = 12V \rightarrow 4V \rightarrow 5V$ ,  $I_{OUT} = 3A$

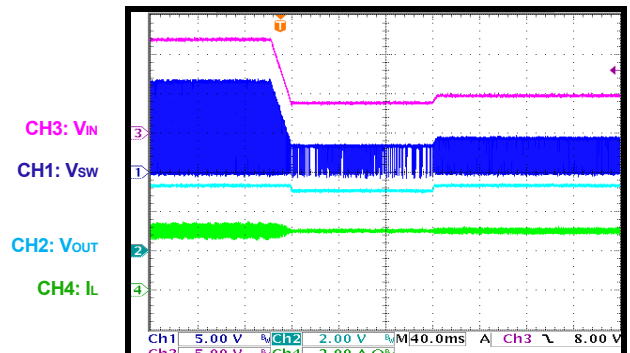

**EVB TEST RESULTS (continued)**

$V_{IN} = 12V$ ,  $V_{OUT} = 3.3V$ ,  $C_{OUT} = 2 \times 22\mu F$ ,  $L = 10\mu H$ ,  $T_A = +25^\circ C$ , unless otherwise noted.

**$V_{IN}$  Ramp Down and Up**

$V_{IN} = 18V \rightarrow 4V \rightarrow 0V \rightarrow 4V \rightarrow 18V$ ,  $I_{OUT} = 0A$

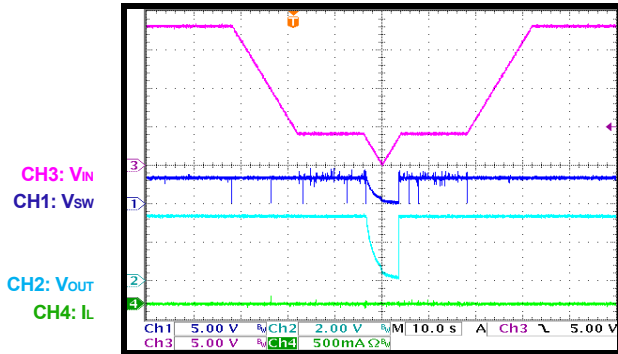

**$V_{IN}$  Ramp Down and Up**

$V_{IN} = 18V \rightarrow 4V \rightarrow 0V \rightarrow 4V \rightarrow 18V$ ,  $I_{OUT} = 3A$

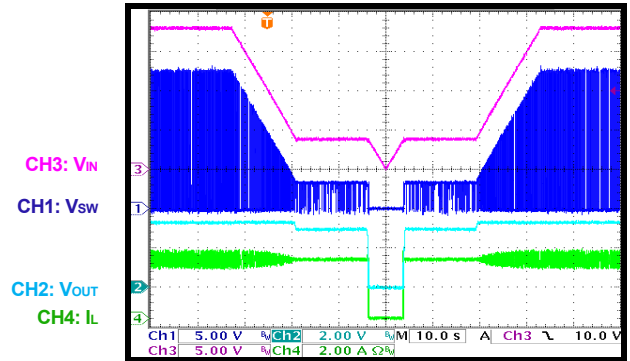

**Load Dump**

$V_{IN} = 12V \rightarrow 36V \rightarrow 12V$ ,  $I_{OUT} = 3A$

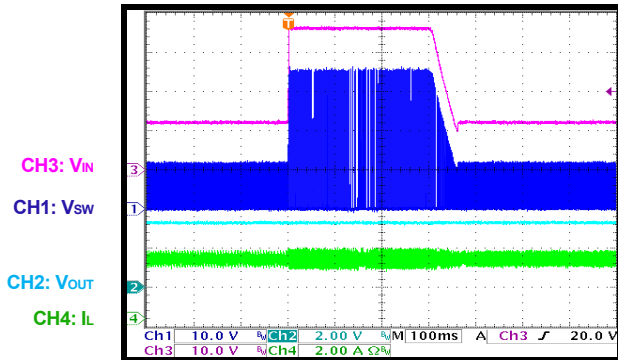



**PRINTED CIRCUIT LAYOUT**

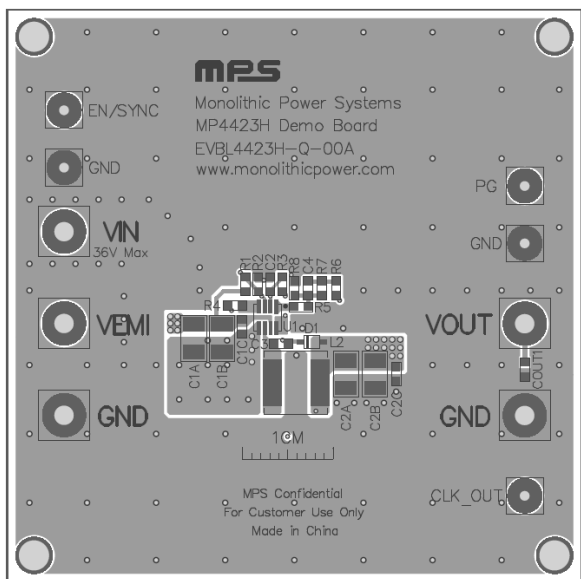

**Figure 1: Top Silk Layer and Top Layer**

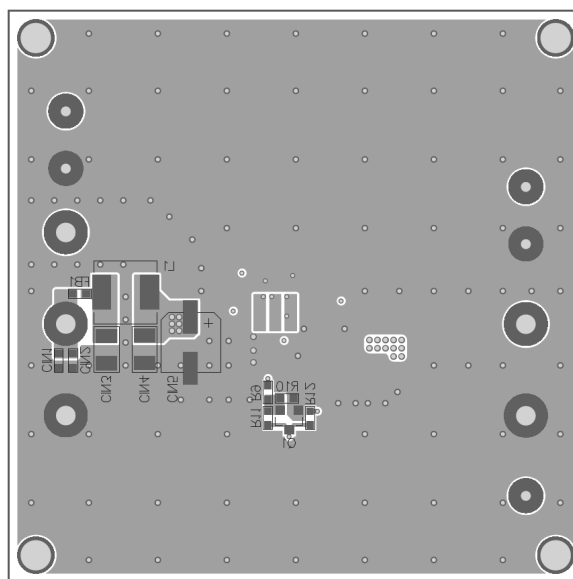

**Figure 2: Bottom Silk Layer and Bottom Layer**

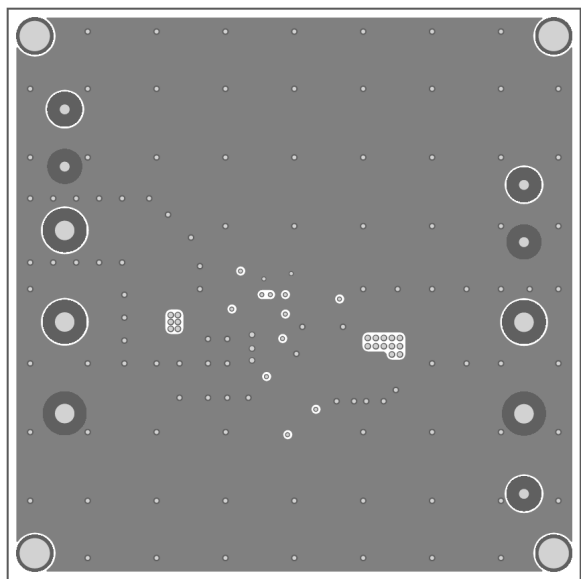

**Figure 3: Inner1 Layer**

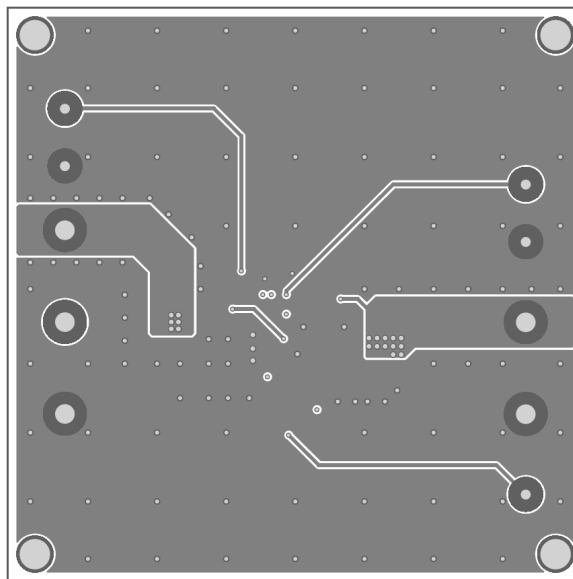

**Figure 4: Inner2 Layer**

## QUICK START GUIDE

1. Connect the positive and negative terminals of the load to the VOUT and GND pins respectively.
2. Preset the power supply output to between 4V to 36V, and then turn it off.
3. Connect the positive and negative terminals of the power supply output to the VIN and GND pins respectively.
4. Turn the power supply on. The MPQ4423H/MPQ4423H-AEC1 will automatically startup.
5. To use the Enable function, apply a digital input to the EN pin. Drive EN higher than 1.65V to turn on the regulator, drive EN less than 1.05V to turn it off. An internal 500kΩ resistor from EN/SYNC to GND allows EN/SYNC to be floated to shut down the chip.
6. Connect the EN input pin through a pull-up resistor (R1) to any voltage connected to the VIN pin. Make sure R1 big enough to limit the EN input current to less than 150μA. For example, with 12V connected to VIN, make sure  $R1 \geq (12V - 6.5V) \div 150\mu A = 36.7k\Omega$ .
7. Connect the EN pin directly to a voltage source without any pull-up resistor requires limiting voltage amplitude to  $\leq 6V$  to prevent damage to the internal zener diode at EN pin.
8. Connect the EN input pin with an external clock with a range of 200kHz to 2.2MHz after output voltage is set to synchronize the internal clock rising edge to the external clock rising edge. The pulse width of external clock signal should be less than 1.7μs.
9. Use R7 and R8 to set the output voltage with  $V_{FB}=0.792V$ . For  $R7=41.2k\Omega$ , R8 can be determined by:

$$R8 = \frac{R7}{\frac{V_{OUT}}{0.792} - 1}$$

Follow the Application Information section in the device datasheet to recalculate the compensation, inductor and output capacitor values when output voltage is changed.

10. CLK\_OUT is a signal inverted to SW and can be used as other buck's sync signal to get 180 degree out of phase. The high voltage of CLK\_OUT is equal to the output voltage of the board, so make sure it is safe for the synchronized part when the output voltage setting value is high.

**NOTICE:** The information in this document is subject to change without notice. Please contact MPS for current specifications. Users should warrant and guarantee that third party Intellectual Property rights are not infringed upon when integrating MPS products into any application. MPS will not assume any legal responsibility for any said applications.