

DESCRIPTION

The MP9442 is a high-frequency, synchronous, rectified, step-down, switch-mode converter with built-in power MOSFETs. It offers a very compact solution to achieve a 2A continuous output current with excellent load and line regulation over a wide input supply range. The MP9442 has synchronous mode operation for higher efficiency over the output current load range.

Current-mode operation provides fast transient response and eases loop stabilization.

Full protection features include over-current protection and thermal shut down.

The MP9442 requires a minimal number of readily-available standard external components, and is available in a space-saving 8-pin TSOT23 package.

ELECTRICAL SPECIFICATIONS (1)

Parameter	Symbol	Value	Units
Input Voltage	V_{IN}	12	V
Output Voltage	V_{OUT}	3.3	V
Output Current	I_{OUT}	0-2	A

Notes:

- 1) For different Input/output voltage specs and different output capacitor/inductor may need change the application circuit parameters.

FEATURES

- Wide 4V to 36V Continuous Operating Input Range
- 90mΩ/55mΩ Low $R_{DS(ON)}$ Internal Power MOSFETs
- High-Efficiency Synchronous Mode Operation
- 600kHz Switching Frequency
- Synchronizes from 200kHz to 2.2MHz External Clock
- High Duty Cycle for Automotive Cold-crank
- Internal Power-Save Mode
- Internal Soft-Start
- Power Good Indicator
- Over-Current Protection with Hiccup
- Thermal Shutdown
- Output Adjustable from 0.8V
- Available in an 8-Pin TSOT23 Package

PACKAGEAPPLICATIONS

- Automotive
- Industrial Control System
- Distributed Power Systems

All MPS parts are lead-free, halogen free, and adhere to the RoHS directive. For MPS green status, please visit MPS website under Quality Assurance.

"MPS" and "The Future of Analog IC Technology" are Registered Trademarks of Monolithic Power Systems, Inc.

TYPICAL APPLICATION



(L x W x H) 6.3cm x 4.9cm x 1.3cm

Board Number	MPS IC Number
EV9442-J-00A	MP9442GJ

Efficiency vs. Load Current

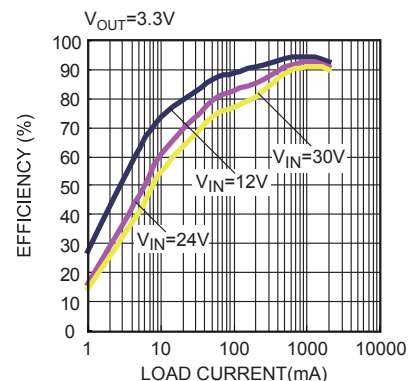

EVALUATION BOARD SCHEMATIC

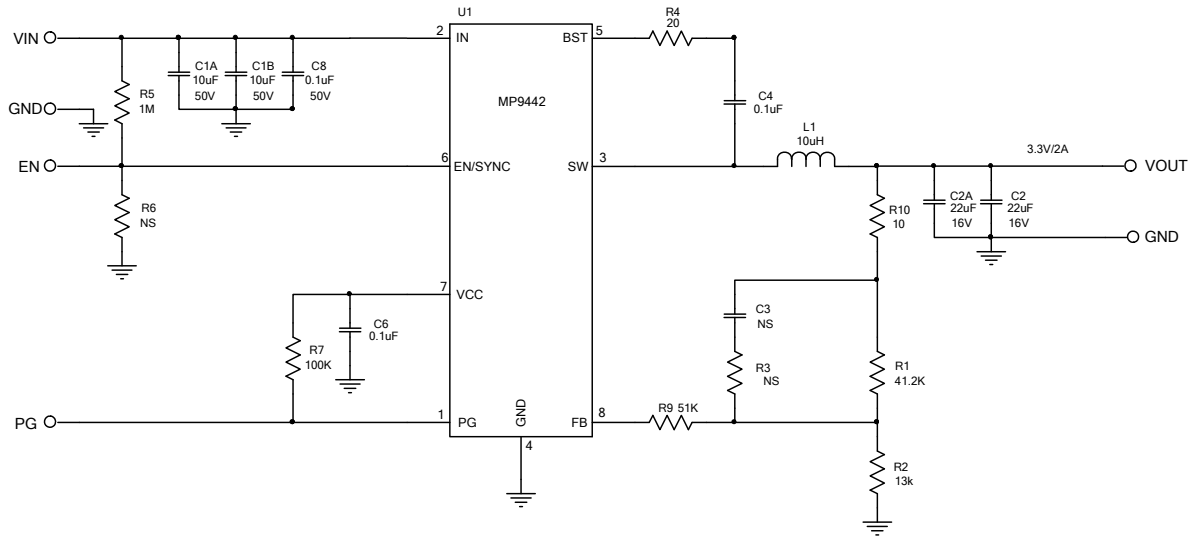

EV9442 BILL OF MATERIALS

Qty	Ref	Value	Description	Package	Manufacturer	Manufacturer P/N
2	C1A, C1B	10 μ F	Ceramic Cap., 50V, X5R	1210	muRata	GRM32ER61H106KA12L
1	C8	0.1 μ F	Ceramic Cap., 50V, X7R	0603	muRata	GRM188R71H104KA93D
2	C2,C2A	22 μ F	Ceramic Cap., 16V, X5R	1206	muRata	GRM31CR61C226ME15L
1	C3	NS				
2	C4,C6	0.1 μ F	Ceramic Cap., 25V, X7R	0603	muRata	GRM188R71E104KA01D
1	R1	41.2k	Thick Film Res., 1%	0603	Yageo	RC0603FR-0741K2L
1	R2	13k	Thick Film Res., 1%	0603	Yageo	RC0603FR-0713KL
1	R3	NS				
1	R4	20 Ω	Thick Film Res., 1%	0603	Yageo	RC0603FR-0720RL
1	R5	1M	Thick Film Res., 1%	0603	Yageo	RC0603FR-071ML
0	R6	NS				
1	R7	100k	Thick Film Res., 1%	0603	Yageo	RC0603FR-07100KL
1	R9	51k	Thick Film Res., 1%	0603	Yageo	RC0603FR-0751KL
1	R10	10 Ω	Thick Film Res., 1%	0603	Yageo	RC0603FR-0710RL
1	L1	10 μ H	Inductor, DCR=33m Ω , Is=4A	SMD	Würth	744314101
1	U1	MP9442GJ	Synchronous Step- Down Converter	TSOT23- 8	MPS	MP9442GJ

EVB TEST RESULTS

Performance waveforms are tested on the evaluation board.

$V_{IN} = 12V$, $V_{OUT} = 3.3V$, $L = 10\mu H$, $R_{BST} = 20\Omega$, $T_A = +25^\circ C$, unless otherwise noted.

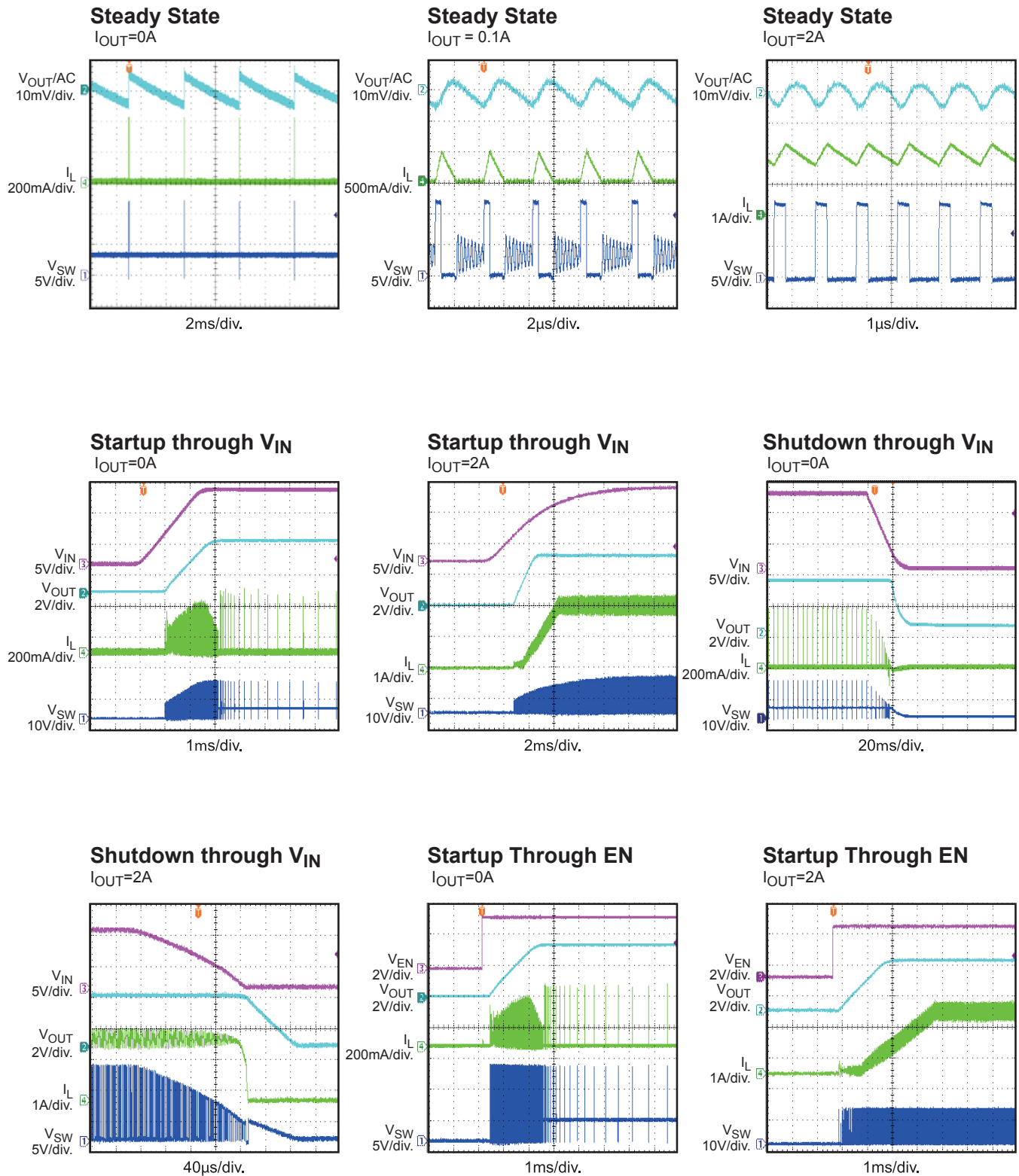

EVB TEST RESULTS (continued)

Performance waveforms are tested on the evaluation board.

$V_{IN} = 12V$, $V_{OUT} = 3.3V$, $L = 10\mu H$, $R_{BST}=20\Omega$, $T_A = +25^\circ C$, unless otherwise noted.



EVB TEST RESULTS (continued)

Performance waveforms are tested on the evaluation board.

$V_{IN} = 12V$, $V_{OUT} = 3.3V$, $L = 10\mu H$, $R_{BST}=20\Omega$, $T_A = +25^\circ C$, unless otherwise noted.

Cold-Crank

$V_{OUT}=5V$, $I_{OUT}=2A$

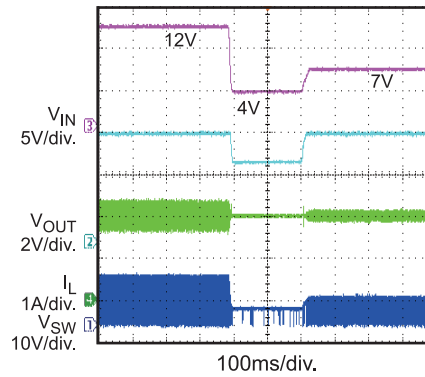

PRINTED CIRCUIT BOARD LAYOUT

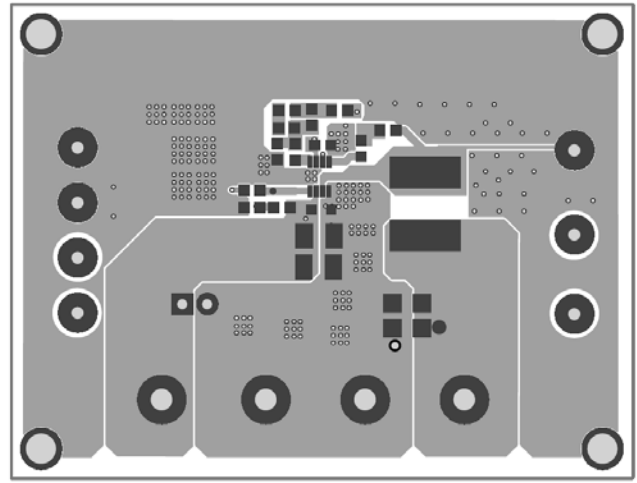
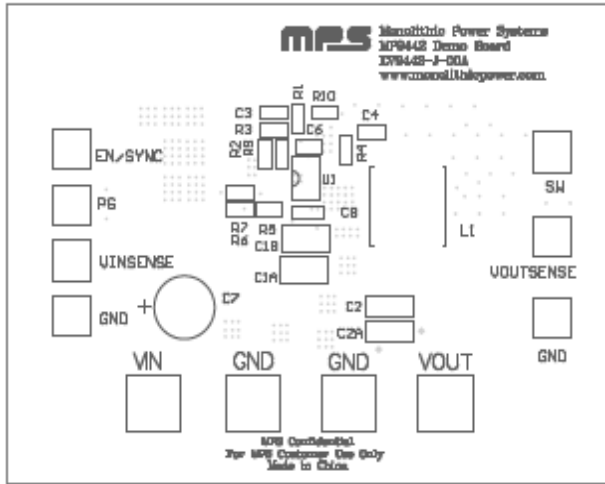

Figure 1—Top Silk Layer

Figure 2—Top Layer

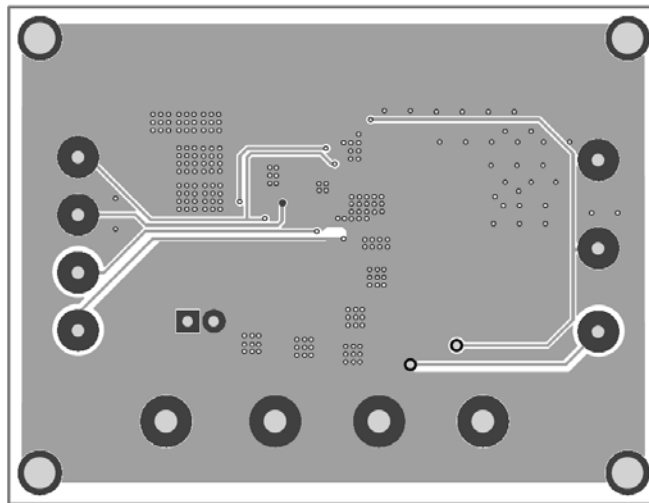

Figure 3—Bottom Layer

QUICK START GUIDE

1. Connect the positive and negative terminals of the load to the VOUT and GND pins, respectively.
2. Preset the power supply output 12V, and then turn off the power supply.
3. Connect the positive and negative terminals of the power supply output to the VIN and GND pins, respectively.
4. Turn the power supply on. The MP9442 will automatically startup.
5. To use the Enable function, apply a digital input to the EN pin. Drive EN higher than 1.4V to turn on the regulator or less than 1.25V to turn it off.
6. To use the external synchronous function to adjust the switching frequency, apply an external clock signal to EN/SYNC pin.

NOTICE: The information in this document is subject to change without notice. Please contact MPS for current specifications. Users should warrant and guarantee that third party Intellectual Property rights are not infringed upon when integrating MPS products into any application. MPS will not assume any legal responsibility for any said applications.