

DESCRIPTION

The EV9184-L-00A Evaluation Board is designed to demonstrate the performances of MPS' MP9184, which can provide 25W load from 3.3V input.

The MP9184 is a 600 kHz fixed frequency, high efficiency, wide input range, current mode boost converter with optional internal or external current sensing configuration for high integration or high power application. It features internally a 10mΩ, 24V power switch and a synchronous gate driver for high conversion efficiency. The MP9184 is available in a low profile 22-pin 3mmx4mm QFN package.

This board is configured for 12V application, the maximum output current is determined by current limit or permitted temperature performance.

ELECTRICAL SPECIFICATION

Parameter	Symbol	Value	Units
Supply Voltage	V _{IN}	3 – 10	V
Output Voltage	V _{OUT}	12	V
Output Current	I _{OUT}	0– OCP ⁽¹⁾	A

Notes:

1) High load power will lead to high IC temperature. Load power should be limited based on temperature performance even current limit is not triggered.

FEATURES

- 3V-to-20V Wide Input Range
- Integrated 10mΩ Low-side Power FET
- SDR Driver for Synchronous Solution
- >17A Switch Current Limit if Sense Current Internally
- Up to 96% efficiency
- Optional Internal/External Current Sensing Configuration
- External Soft-Start and Compensation for Higher Flexibility
- Programmable UVLO and Hysteresis
- < 1μA Shutdown Current
- Thermal Shutdown at 150°C
- Available in 3x4mm QFN-22 Package

PACKAGE APPLICATIONS

- Thunderbolt Interface
- Notebook and Tablet
- Bluetooth Audio
- Power Banks
- Fuel Cells
- POS Systems

All MPS parts are lead-free, halogen free, and adhere to the RoHS directive. For MPS green status, please visit MPS website under Quality Assurance. "MPS" and "The Future of Analog IC Technology" are Registered Trademarks of Monolithic Power Systems, Inc.

EV9184-L-00A EVALUATION BOARD



(L × W × H) 6.3cm × 6.3cm × 1.3cm	
Board Number	MPS IC Number
EV9184-L-00A	MP9184GL

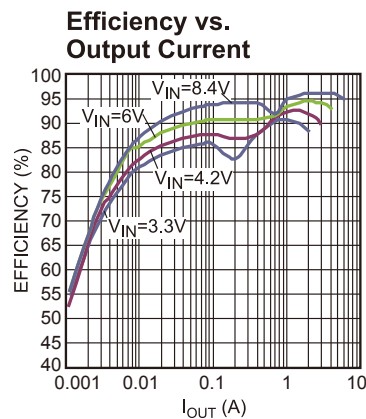

EVALUATION BOARD SCHEMATIC

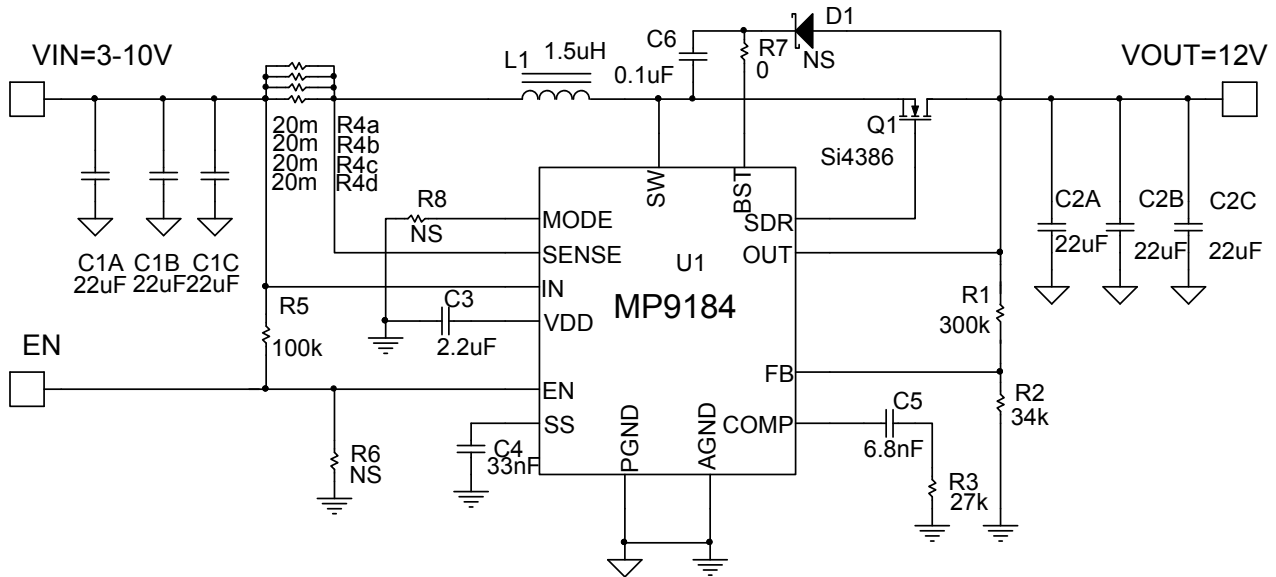

EV9184-L-00A BILL OF MATERIALS

Qty	Value	Designator	Description	Package	Manufacturer	Manufacturer P/N
6	22 μ F	C1A, C1B, C1C, C2A, C2B, C2C	25V, ceramic Capacitor	1210	muRata	GRM32R71E226KL
1	2.2 μ F	C3	25V, ceramic Capacitor	0805	muRata	GRM21AR71E225KL
1	33nF	C4	50V ceramic capacitor	0603	muRata	GRM188R71H333KL
1	6.8nF	C5	50V ceramic capacitor	0603	muRata	GRM188R71H682KL
1	0.1 μ F	C6	50V, ceramic Capacitor	0603	muRata	GRM188R71H104KL
1	300k	R1	Film resistor, 1%	0603	YAGEO	RC0603FR-07300KL
1	34k	R2	Film resistor, 1%	0603	YAGEO	RC0603FR-0734KL
1	27k	R3	Film resistor, 1%	0603	YAGEO	RC0603FR-0727KL
4	20m	R4a, R4b, R4c, R4d	low ohmic Film resistor, 1%	0805	YAGEO	PR0805FKF070R020L
1	100k	R5	Film resistor, 5%	0603	YAGEO	RC0603JR-07100KL
0	NS	R6, R8		0603		
1	0	R7	Film resistor, 5%	0603	YAGEO	RC0603JR-070RL
0	NS	D1		SOD-323		
1	1.5 μ H	L1	6.6mOhm, 14A inductor	SMD	Würth	744311150
1	Si4386	Q1	30V, 8mOhm 15A, N-Channel MOS	SOIC8	VISHAY	Si4386DY
1	MP9184	U1	3~20V, 17A, 600kHz boost converter	QFN22-3*4	MPS	MP9184GL

EVB TEST RESULTS

Performance waveforms are tested on the evaluation board.

$V_{IN} = 3.3V$, $V_{OUT} = 12V$, $I_{OUT}=2.1A$, $L = 1.5\mu H$, $T_A = 25^\circ C$, $MODE=$ float, $R_{SENSE}=5m\Omega$, unless otherwise noted.

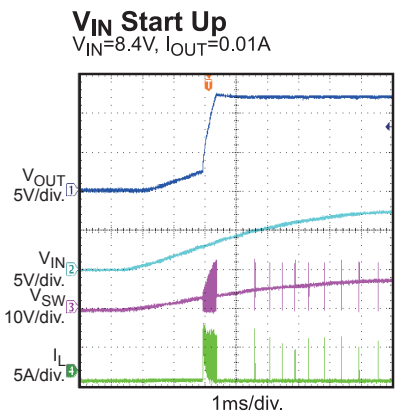
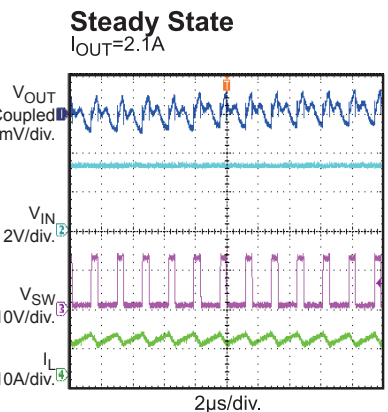
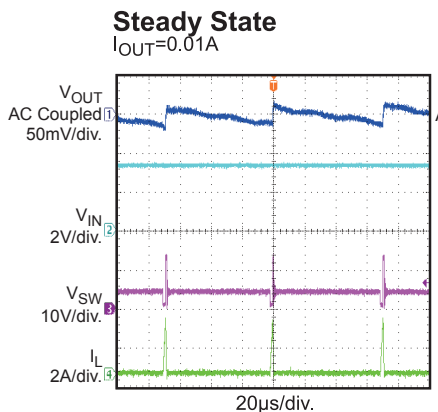
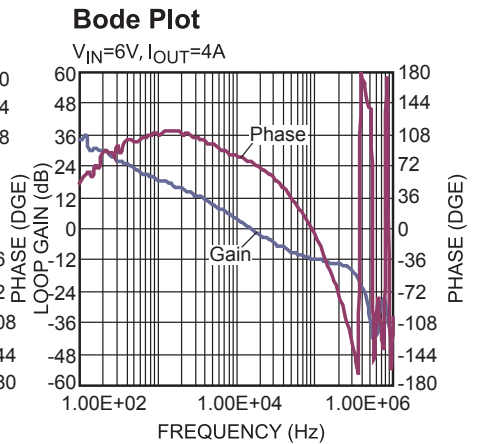
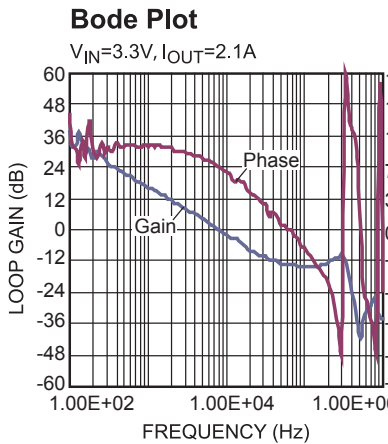
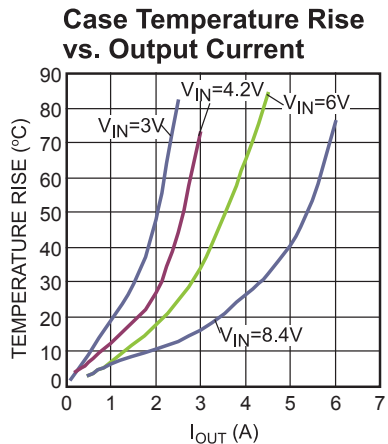
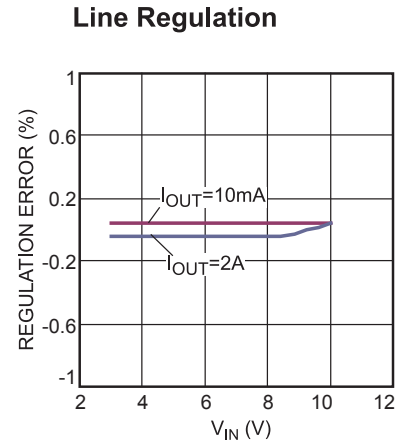
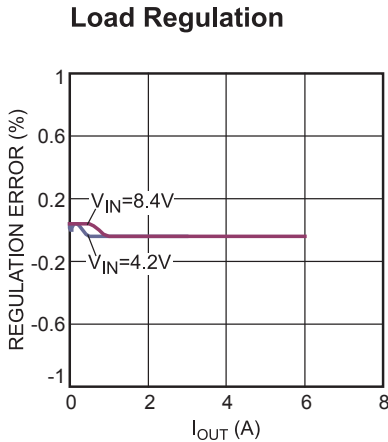
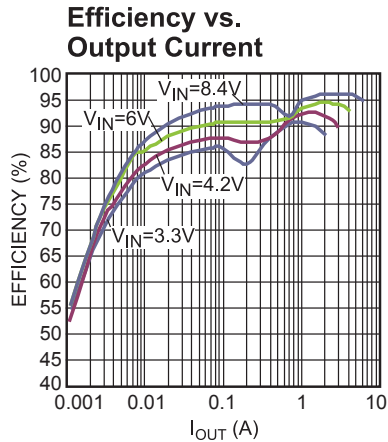

EVB TEST RESULTS (continued)

Performance waveforms are tested on the evaluation board.

$V_{IN} = 3.3V$, $V_{OUT} = 12V$, $I_{OUT} = 2.1A$, $L = 1.5\mu H$, $T_A = 25^\circ C$, $MODE = float$, $R_{SENSE} = 5m\Omega$, unless otherwise noted.

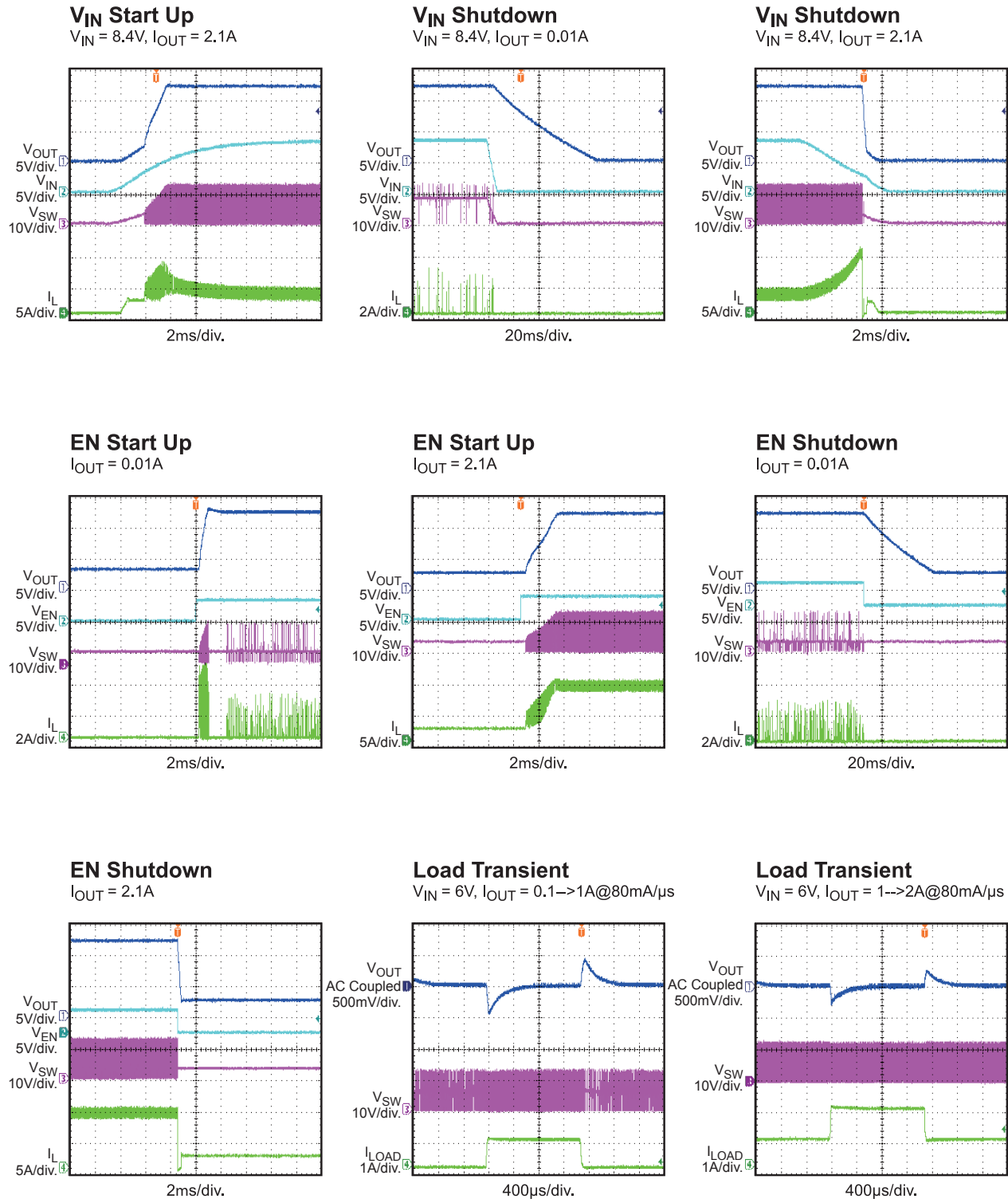

PRINTED CIRCUIT BOARD LAYOUT

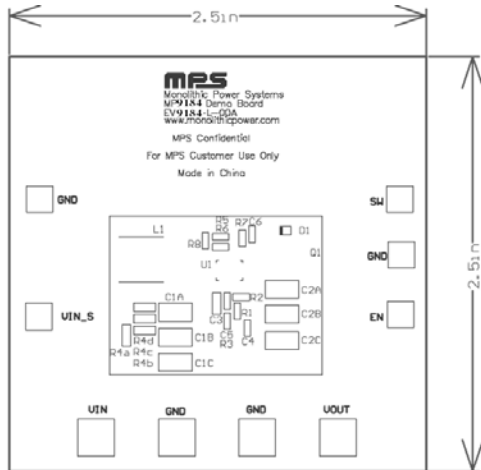

Figure 1: Top Silkscreen Layer

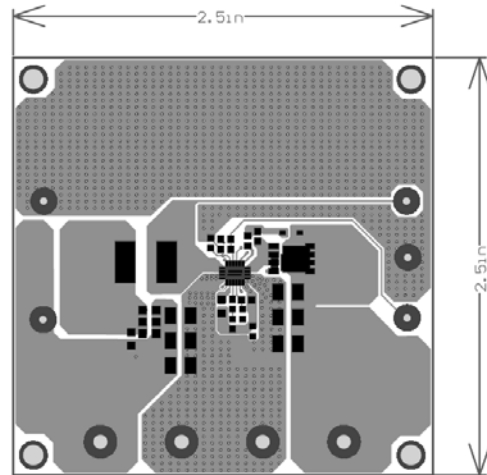

Figure 2: Top Layer

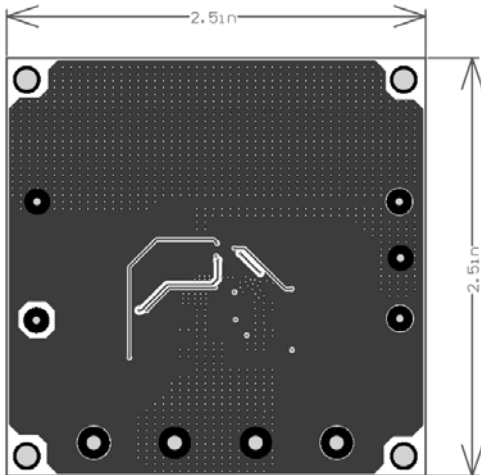

Figure 3: Middle Layer 1

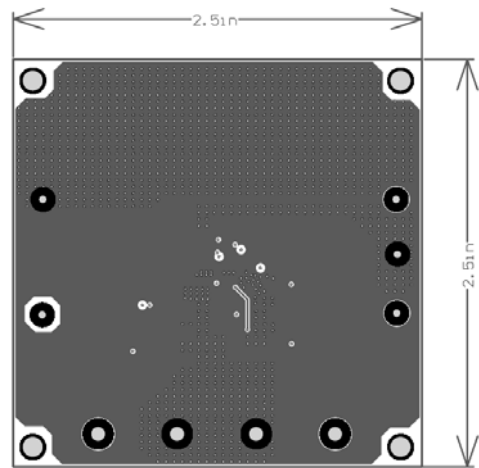

Figure 4: Middle Layer 2

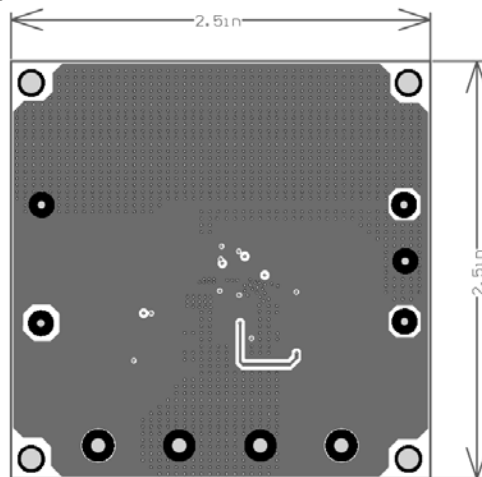

Figure 5: Bottom Layer

QUICK START GUIDE

The output voltage of this board is set to 12V. The board layout accommodates most commonly used inductors and output capacitors. With an input ranging from 3V to 10V, this board can provide load up to 25W. To use this EVB for evaluation, you can do as below:

1. Preset Power Supply to between 3V and 10V.
2. Turn Power Supply off.
3. Preset Load to a value, for example, 1.5A.
4. Connect Power Supply terminals to:
 - a. Positive (+): VIN
 - b. Negative (-): GND
 - c. Connect Load to:
 - d. Positive (+): VOUT
 - e. Negative (-): GND
5. Turn Power Supply on after making connections. The MP9184 will automatically startup to work.

The output voltage VOUT can be programmed by changing R2. And the value of R2 can be calculated by the following formula:

$$R2 = R1 \times \frac{V_{FB}}{V_{OUT} - V_{FB}}$$

Where R1=300kΩ, and $V_{FB}=1.225V$.

If EN function is preferred, apply a high level (>1.39V) turns on MP9184, low level (<0.4V) turns off MP9184. After being turned off, output voltage will be discharged to equal to Vin due to load.

The default configuration of this board is using external sensing resistor. To use the internal sensing block, first shut off power supply, then connect MODE pin (find it by looking for R8 on the board) to GND through R8 of which the value should be 0Ω. After power-on, MP9184 automatically uses internal sensing resistor.

NOTICE: The information in this document is subject to change without notice. Please contact MPS for current specifications. Users should warrant and guarantee that third party Intellectual Property rights are not infringed upon when integrating MPS products into any application. MPS will not assume any legal responsibility for any said applications.