

### DESCRIPTION

The EV9151-D-00A is for demonstrating MPS's MP9151, a high-frequency, synchronous, rectified, step-down, switch-mode converter with internal power MOSFETs. MP9151 offers a very compact solution to achieve 4A continuous output current over a wide input supply range with excellent load and line regulation. The MP9151 operates at high efficiency over a wide output current load range.

Current-mode operation provides fast transient response and eases loop stabilization. The full protection features include over-current protection and thermal shutdown.

The MP9151 requires a minimal number of readily-available standard external components and comes in a space saving 2x3mm 14-pin QFN package.

### ELECTRICAL SPECIFICATION

Parameter	Symbol	Value	Units
Input Voltage	$V_{IN}$	5 – 20	V
Output Voltage	$V_{OUT}$	3.3	V
Output Current	$I_{OUT}$	4	A

### FEATURES

- Wide 5V to 20V Operating Input Range
- 4A Output Current
- Low  $R_{DS(ON)}$  Internal Power MOSFETs
- Programmable Switching Frequency from 300kHz to 1.6MHz
- EN ON/OFF Control
- Power Good Indicator
- External Soft Start
- OCP and Thermal Shutdown
- Available in 14-pin QFN2x3 Package

### APPLICATIONS

- DSL Modems
- Cable Modems
- Set Top Boxes

All MPS parts are lead-free and adhere to the RoHS directive. For MPS green status, please visit MPS website under Quality Assurance. "MPS" and "The Future of Analog IC Technology" are Registered Trademarks of Monolithic Power Systems, Inc.

ADAM (Analog Digital Adaptive Modulation), AAM (...) are Trademarks of Monolithic Power Systems, Inc.

### EV9151-D-00A EVALUATION BOARD

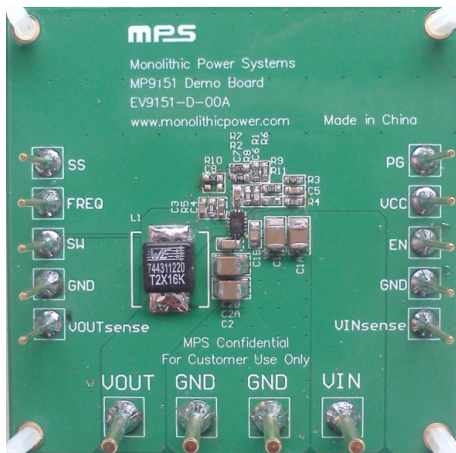

Board Number	MPS IC Number
EV9151-D-00A	MP9151GD

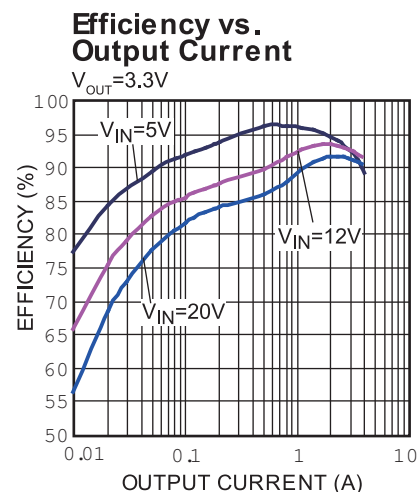

## EVALUATION BOARD SCHEMATIC

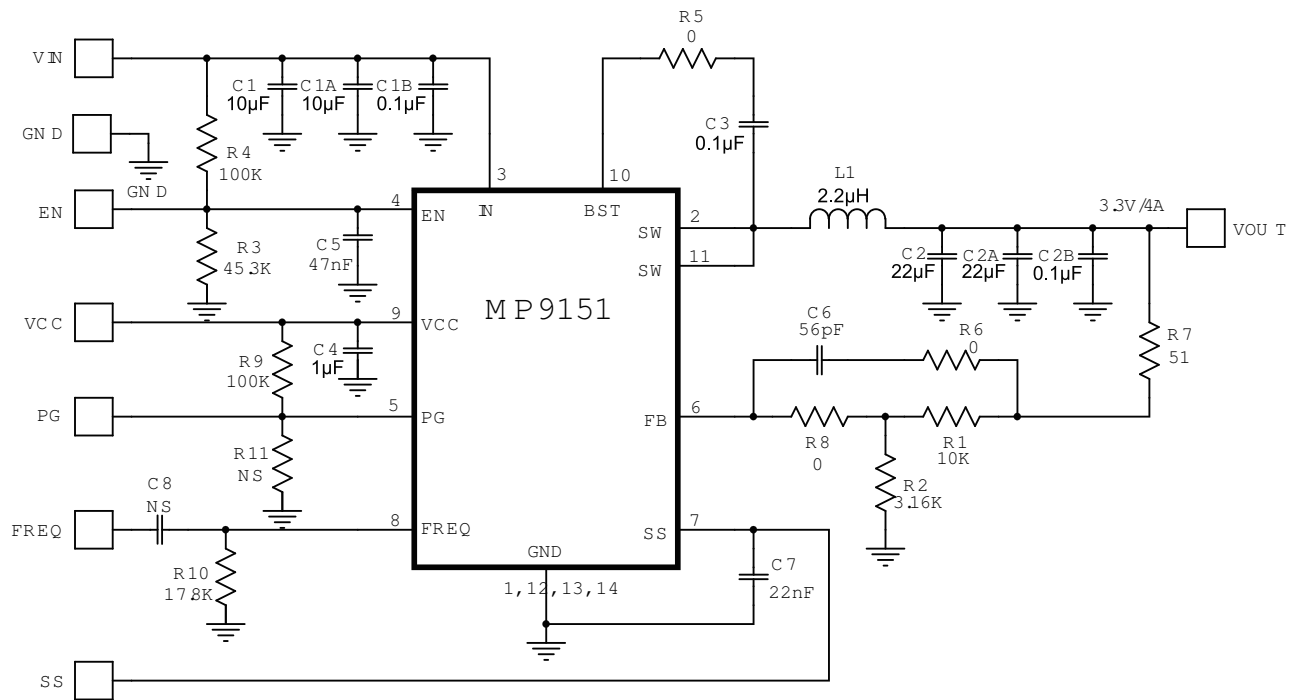

## EV9151-D-00A BILL OF MATERIALS

Qty	Ref	Value	Description	Package	Manufacturer	Part Number
2	C1, C1A	10µF	Ceramic Cap., 25V, X7R	1210	MuRata	GRM32DR71E106KA12L
2	C1B,C2B	0.1µF	Ceramic Cap., 25V, X7R	0805	MuRata	GRM21BR71E104KA01L
2	C2, C2A	22µF	Ceramic Cap., 10V, X7R	1210	MuRata	GRM32ER71A226KE20L
1	C3	0.1µF	Ceramic Cap., 25V, X7R	0603	MuRata	GRM188R71E104KA01D
1	C4	1µF	Ceramic Cap., 16V, X7R	0603	MuRata	GRM188R71C105KA12D
1	C5	47nF	Ceramic Cap., 16V, X7R	0603	MuRata	GRM188R71C473KA01D
1	C6	56pF	Ceramic Cap., 50V, C0G	0603	Murata	GRM1885C1H560JA01D
1	C7	22nF	Ceramic Cap., 50V, X7R	0603	Murata	GRM188R71H223KA01D
1	R1	10kΩ	Film Res., 1%	0603	Yageo	RC0603FR-0710KL
1	R2	3.16kΩ	Film Res., 1%	0603	Yageo	RC0603FR-073K16L
1	R3	45.3kΩ	Film Res., 1%	0603	Yageo	RC0603FR-0745K3L
2	R4, R9	100kΩ	Film Res., 1%	0603	Yageo	RC0603FR-07100KL
3	R5, R6, R8	0	Film Res., 1%	0603	Yageo	RC0603JR-070RL
1	R7	51Ω	Film Res., 1%	0603	Yageo	RC0603FR-0751RL
1	R10	17.8kΩ	Film Res., 1%	0603	Yageo	RC0603FR-0717K8L
0	R11, C8	NS				
1	L1	2.2µH	DCR=11.4mΩ, Is=13A	7x7x4mm	Würth	744311220
1	U1	MP9151	Step-Down Converter	QFN14 (2x3)	MPS	MP9151GD

## EVB TEST RESULTS

Performance waveforms are tested on the evaluation board.

$V_{IN} = 12V$ ,  $V_{OUT} = 3.3V$ ,  $L = 2.2\mu H$ ,  $f_{SW} = 800kHz$ ,  $T_A = +25^\circ C$ , unless otherwise noted.

**Input / Output Ripple**  
 $I_{OUT} = 4A$

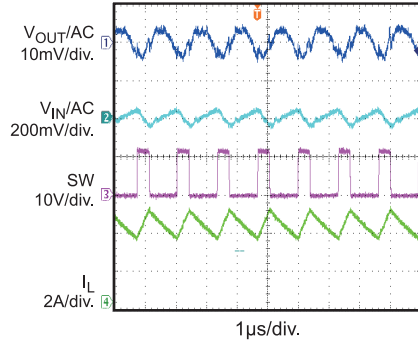

**Load Transient Reponse**  
 $I_{OUT} = 2A-4A, 250mA/\mu s$

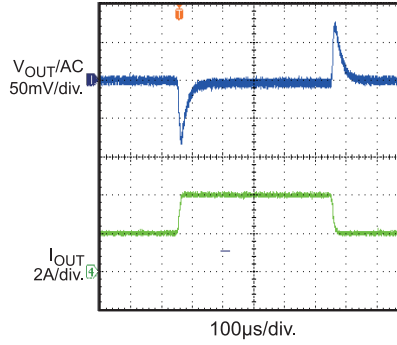

**Startup through Enable**  
 $I_{OUT} = 0A$

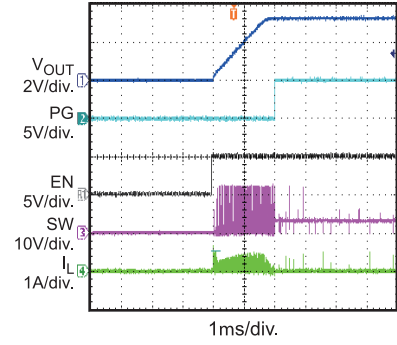

**Startup through Enable**  
 $I_{OUT} = 4A$

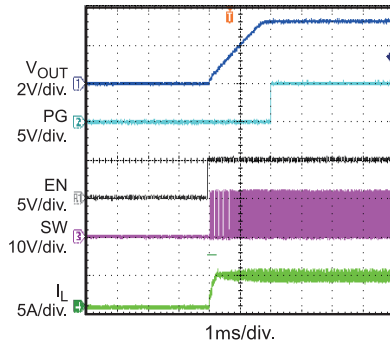

**Shutdown through Enable**  
 $I_{OUT} = 0A$

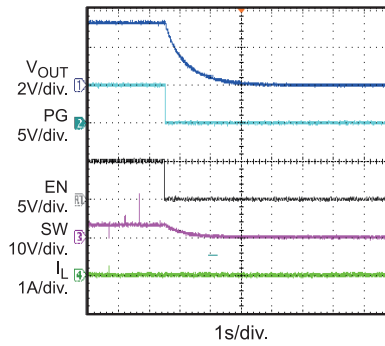

**Shutdown through Enable**  
 $I_{OUT} = 4A$

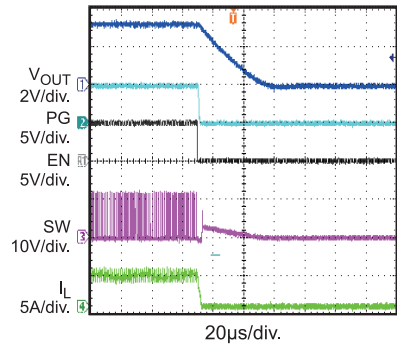

**Short Entry**  
 $I_{OUT} = 0A$

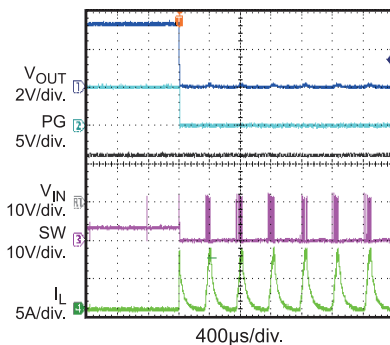

**Short Recovery**  
 $I_{OUT} = 0A$

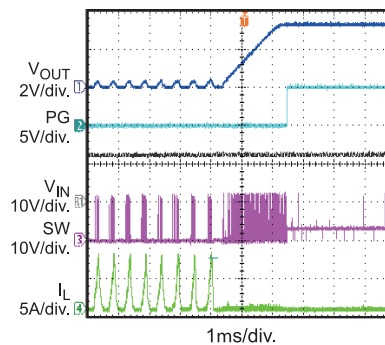

**Case Temperature Rise vs. Output Current**  
 $V_{IN} = 12V$ ,  $I_{OUT} = 1A-4A$ ,  $T_A = 21.5^\circ C$

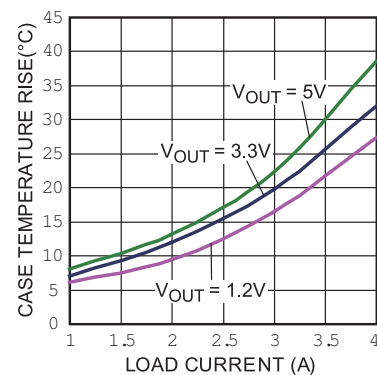

**PRINTED CIRCUIT BOARD LAYOUT**

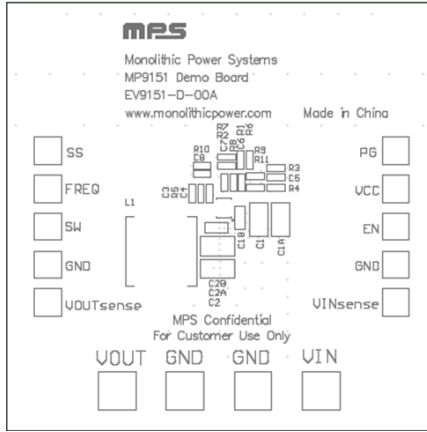

**Figure 1—Top Silk Layer**

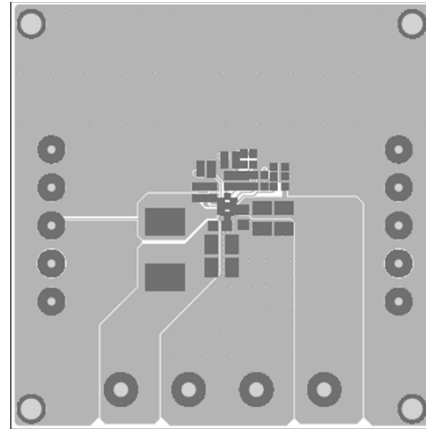

**Figure 2—Top Layer**

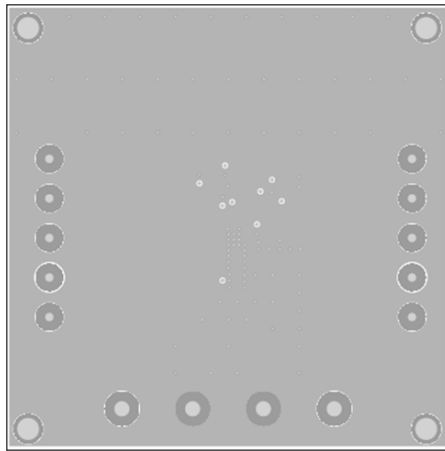

**Figure 3—Inner 1 Layer**

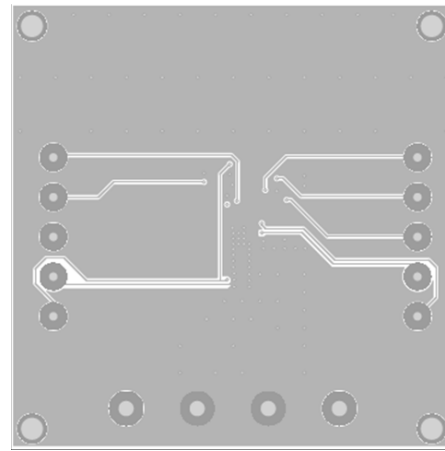

**Figure 4— Inner 2 Layer**

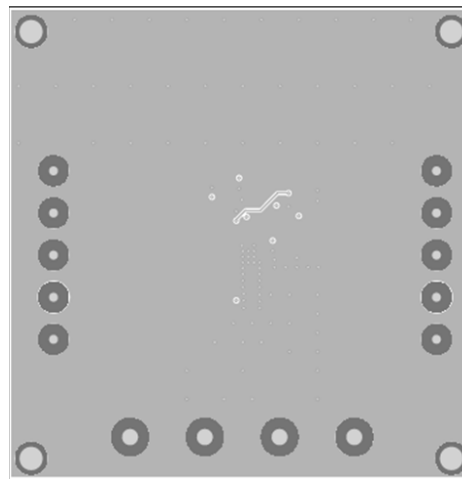

**Figure 5— Bottom Layer**

## QUICK START GUIDE

1. Connect the positive and negative terminals of the load to the VOUT and GND pins, respectively.
2. Preset the power supply output between 5V and 20V, and then turn off the power supply.
3. Connect the positive and negative terminals of the power supply output to the VIN and GND pins, respectively.
4. Turn the power supply on. The board will automatically start up.
5. To use the Enable function, apply a digital input to the EN pin. Drive EN higher than 1.6V to turn on the regulator or less than 0.4V to turn it off.
6. Change the external resistor from FREQ pin to GND to set frequency from 300kHz to 1.6MHz.

**NOTICE:** The information in this document is subject to change without notice. Please contact MPS for current specifications. Users should warrant and guarantee that third party Intellectual Property rights are not infringed upon when integrating MPS products into any application. MPS will not assume any legal responsibility for any said applications.